



www.lcra.org

HIGHLAND LAKES WATERSHED ORDINANCE

WATER QUALITY MANAGEMENT TECHNICAL MANUAL

Effective July 1, 2007

HIGHLAND LAKES WATERSHED ORDINANCE

**WATER QUALITY MANAGEMENT
TECHNICAL MANUAL**

EFFECTIVE JULY 1, 2007

FIFTH EDITION

Lower Colorado River Authority

Introduction

Pollution carried by stormwater runoff represents a threat to the water quality of the Highland Lakes and its tributaries. According to the Environmental Protection Agency, stormwater runoff carrying pollutants from the land is the largest contributor to water quality degradation nationwide.

For 17 years, LCRA has actively managed stormwater runoff around the Highland Lakes. The Board began its role in managing stormwater runoff in 1990 by adopting the Lake Travis Nonpoint Source Pollution Control Ordinance and again in 1992 by adopting the Upper Highland Lakes Nonpoint Source Pollution Control Ordinance. In September 2004, LCRA staff launched a review of the two ordinances to ensure that the most recent science and technologies are considered. In addition, a year-long stakeholder process provided input from a diverse group of concerned people whose livelihood greatly rests on the good water quality of the Highland Lakes. The result is the Lake Travis and the Upper Highland Lakes Nonpoint Source Pollution Control Ordinances were combined and renamed the Highland Lakes Watershed Ordinance.

The amendments to the technical manual on July 1, 2007 include the incorporation of water quality protection guidance for quarry and mine activities subject to the Highland Lakes Watershed Ordinance, revised March 1, 2007. These ordinance revisions followed an eight-month process with the quarry and mine stakeholder committee. Additional technical manual revisions included BMP enhancements and several new options to protect water quality.

LCRA Ordinance Jurisdictional Area

Property located in the Lake Travis watershed in Travis County, the portion of the Colorado River watershed in Burnet County and a portion of Llano County as shown in Appendix 1.1.1 are subject to the Highland Lakes Watershed Ordinance. Property owners/developers/utilities may be required to obtain a permit(s) prior to the start of any work, including clearing of the property.

For more information contact:

Lower Colorado River Authority
Water Resource Protection – L421
P.O. Box 220
Austin, TX 78767-0220
800-776-5272, Ext. 2324
512-473-3200, Ext. 2324

How Water Quality Protection is Provided

In 2004 and 2005, LCRA met with many individuals and worked with the two stakeholder committees to create a watershed protection ordinance that is fair, easy to understand and provides measures to protect water quality. Most committee members agreed that relying on end-of-pipe permanent best management practices (BMP) as the sole treatment device is not the ideal approach in managing stormwater runoff. In addition, the Lake Travis stakeholders recommended that several treatment systems be in place to improve water quality management. The utilization of treatment systems will improve stormwater runoff treatment due to their

differing abilities in the management of varying runoff constituents. An added benefit is that if one system begins to experience reduced pollutant removal efficiency, the other system(s) remain in place to provide water quality protection.

The potential on-the-ground management systems include vegetated filter strips, permanent water quality basins (sand filtration, extended detention, wet pond, wetland, retention-irrigation, bioretention), infiltration practices, and other methods such as native landscaping, disconnected impervious cover, porous pavement, and rainwater collection to reduce runoff volume. While permanent water quality basins show good performance in the management of total suspended sediment, they typically lack the same capability in the management of phosphorus and other dissolved constituents. Thus, the incorporation of vegetation and infiltration upstream and/or downstream of the structural control will significantly enhance phosphorus management and serve as a back-up system to the structural controls. This approach is not a new concept and is consistent with the practices found in the Lake Travis and Upper Highland Lakes Nonpoint Source Pollution Control Ordinances.

Permanent water quality basins do play an important role in the management of stormwater runoff rate and frequency to protect the creeks from accelerated channel erosion. Therefore, when impervious cover levels exceed the ordinance threshold found under alternate standards, permanent water quality basins will be included in the stormwater management system. However, due to pollutant removal performance, only bioretention and retention-irrigation can serve as stand-alone BMPs in the management of stormwater runoff. But, these basins can be costly, so other basins such as extended detention basins can be combined with upstream vegetated filter strips to satisfy the pollutant removal requirements.

Creek buffer zones are a new addition in water quality protection and found in the revised Highland Lakes Watershed Ordinance. To protect the creek buffer from erosion and scour, permanent BMPs will discharge in a sheet flow manner to the buffer zones. This offers another opportunity to incorporate sheet flow enhancement with water quality treatment. In the design process, the designer may select the placement of vegetated filter strips upstream of the permanent water quality basin. Stormwater runoff from yards, paved areas, disturbed sites, and houses will flow across the filter strips to the conveyance system to the permanent water quality basin. Stormwater treatment will occur within the basin through settling, filtering, and nutrient uptake processes, then, runoff will be discharged at a slow rate over a two to three day period to the buffer zone or receiving conveyance system. To convert the basin discharge to sheet flow, the designer has the option of constructing an infiltration device, flow spreader, or vegetated filter strip. These sheet flow creating mechanisms will rely on infiltration and filtering to polish the stormwater runoff before it enters the buffer zone. The buffer zone will then be able to further infiltrate and filter runoff. In most storm events, these systems will generate minimal to no discharge.

To minimize pollution at the source within development projects, LCRA will provide water quality education materials relating to the Hill Country Option Landscape Specifications which recommends limited use of fertilizers, pesticides, and herbicides. This education effort will be conducted by LCRA staff and include at least one annual meeting with the neighborhood association and provide training programs to homebuilders, landscapers, and residents.

In summary, the stormwater treatment process for development that contains more than 15% gross impervious cover will most likely follow the model below:

- Water quality education to homebuilders and landscapers for implementation of laws that require low amounts of fertilizers, herbicides, and pesticides,
- Water quality education to subdivision residents and commercial operators in the proper management of landscaped areas and good-house keeping practices,
- Permanent water quality basins to treat stormwater runoff and manage stormwater runoff rate to minimize accelerated creek bank erosion,
- Discharges from the structural controls will discharge to vegetated filter strips or and/or infiltration BMPS to further polish runoff quality and convert point discharges to sheet flow. This will occur up-gradient of the buffer zone,
- Runoff enters the buffer zone in a sheet flow manner allowing vegetation and soil to further manage stormwater runoff quality and rate, and
- A maintenance permit is required for permanent water quality basins. At a minimum, inspections will be performed at least once per year. Basin operators will be required to maintain and operate the facility as designed, otherwise, operators are subject to enforcement or LCRA can maintain the facility and assess the costs to the operator.

In the end, six different systems are in place to manage post construction water quality from development projects. This approach provides redundancy in the treatment process to ensure performance and minimize maintenance. Also, the use of vegetation and soils in combination with the permanent control will result in minimal discharge from most storms, which closely mimics the pre-development hydrologic regime and serve as effective creek erosion protection. Base-flow augmentation can be an added benefit of this process.

Organization of the Technical Manual

The purpose of this Technical Manual is to provide property owners/developers/quarry and mine operators and other interested persons with guidance on the LCRA permit requirements and review procedures and to present acceptable practices for meeting the water quality and channel erosion protection standards found in the Highland Lakes Watershed Ordinance. The Technical Manual provides information on standard best management practices (BMPs) for stormwater management (water quality and creek erosion management). Property owners/developers/quarry and mine operators may propose other stormwater management approaches, provided adequate technical information is available to demonstrate that alternative approaches will meet the required performance standards. The Technical Manual is structured in the following manner to facilitate the selection of the most appropriate and cost effective BMPs:

Section I - Development

- Chapter 1** *Permitting Procedures and Requirements.* This includes information on the review of the preliminary and final plats, development permits, utility permits, master plan requirements, public meetings, and the variance process. Appendix 1 provides forms, submittal requirements, permit applications, letter of credit examples, and the Highland Lakes Watershed Ordinance.
- Chapter 2** *Water Quality Management* This chapter identifies the steps necessary for pre-development planning, a methodology to comply with Alternate Standards to reduce permit processing time and fees, design calculations to determine BMP type and size, sediment and erosion control planning during construction, creek buffer zone guidance, and tools to utilize in water quality education. Appendix 2 includes several example projects and the application of the technical criteria to those projects.
- Chapter 3** *Temporary Sediment and Erosion Controls:* Numerous techniques are listed and detailed in the management of sediment and erosion during the construction phase.
- Chapter 4** *Permanent Best Management Practices (Water Quality Treatment).* Options to manage stormwater quality and runoff rate and presented in detail to allow the designer to select the appropriate BMP and be fully aware of the design, construction, maintenance, and vegetation requirements.
- Chapter 5** *Permanent Best Management Practice Maintenance Requirements:* This chapter lists the general and specific maintenance needs and schedules to ensure that the BMP operates as intended in the design.
- Chapter 6** *Dredge and Fill Standards.* Standards are presented for the construction of shoreline projects along the Highland Lakes.

Section II – Quarry and Mine Activity

- Chapter 1** *Permitting Procedures and Requirements.* This includes information on the determination of permit status and the permit process. Appendix 1 provides forms, submittal requirements, permit applications, letter of credit examples, and the Highland Lakes Watershed Ordinance.
- Chapter 2** *Water Quality Management* This chapter identifies the steps necessary for pre-quarry and mine planning, surface water quality protection, groundwater quality protection, design calculations to determine BMP type and size, sediment and erosion control planning during site disturbance, creek buffer zone guidance and permanent BMP maintenance guidance.

Glossary: A list of terms and definitions is provided.

Bibliography: A list of references is provided.

Appendices: Forms and background information.

What's New in the Technical Manual?

This section highlights some of the new stormwater design procedures that are being introduced in this manual. It is provided to help designers understand how the new manual may affect the preparation of stormwater management plans and practices.

- The designer no longer needs to compute pollutant loads for total suspended sediment, total phosphorus, and oil and grease. The new methodology provides water quality storage volume using approved BMP options that can meet the pollutant removal targets.
- The design methodology computes the runoff volume from the 1-year storm (1.93 inches) to size the water quality basins (if required) and the corresponding secondary BMPs (vegetated filter strips, infiltration trenches, or basins). The runoff volume is derived from the amount of impervious cover created by the development. No longer will a designer need to compute two storms to determine compliance with the water quality and channel erosion management goals.
- A development project will need to obtain a permit when the proposed impervious cover is greater than 10,000 square feet.
- Alternate Standards for development (single family and commercial projects) are based upon a total project impervious cover of 15% instead of the lot size requirements found in the previous ordinances. Projects must also use sheet flow techniques to gain compliance with Alternate Standards (i.e. no curb and gutter along streets).
- Alternate Standards are available for commercial development less than three (3) acres in area when utilizing sheet flow techniques and vegetated filter strips per this Manual.
- Fast Track Permits are issued for projects in compliance with the Alternate Standards. Permits can be issued within 30 days of receipt of a completed application. Permit fees are also reduced.
- Stormwater credits (innovative site planning techniques) are available to reduce the effective impervious cover to assist a development in gaining compliance with the Alternate Standards or reducing the permanent BMPs size and cost.
- Buffer zones are applied to creeks with drainage areas greater than five (5) acres. The buffer zones are to remain free of construction except for items noted in Chapter 2.
- Construction erosion control design criteria is included to determine the site's susceptibility to discharge sediment and provides the temporary measures to manage erosion and promote rapid re-vegetation of disturbed areas.
- Water quality education is required for homeowners and commercial operators through LCRA sponsored programs and education materials.
- A permit is no longer required from LCRA to perform dredge and fill (shoreline stabilization) projects. A property owner must follow the LCRA Dredge/Fill Standards to be in compliance with the Ordinance and continue to coordinate with the Corps of Engineers. However, when dredging activity is more than 500 cubic yards in volume or

the length of shoreline protection exceeds 500 feet, then, the property owner must notify LCRA before the activity commences. The Standards approach is similar to the LCRA's operation of the Dock Standards program.

- Specific guidance for quarry and mine activities to comply with Highland Lakes Watershed Ordinance amendments, effective March 1, 2007.

Acknowledgements

We would like to acknowledge the many people who assisted LCRA in the review, revision, and creation of the Highland Lakes Watershed Ordinance. In particular we are grateful to the Lake Travis stakeholder committee composed of the following: Gene Lowenthal, Rick Wheeler, P.E. (Malone/Wheeler, Inc.), Charlie Teeple (Teeple Partners), Dave Fowler (Travis County), Don Lawler (Pedernales River Advisory Panel), David Venhuizen, P.E., Bob Vann (Protect Lake Travis Association), Jan Yenawine (Village of Volente Mayor), Marilee Pfannstiel (City of Jonestown), John Noell, P.E. (Urban Design Group), Pepper Morris, Paul Duncan (City of Lakeway), Dicky Streety, Bill Gunn, Casey Sledge (City of Bee Cave), Tim Haynie, Sr., P.E. (Haynie Consulting, Inc.), Jon Beall (Save Barton Creek Association), and Kendria Ray (Texas State Soil and Water Conservation Board).

And the Upper Highland Lakes stakeholder committee composed of the following....Herb Darling (Burnet County), James Oakley (Burnet County Commissioner), Judy Miller (City of Marble Falls), David Vaughn (City of Burnet), Greg Haley, P.E. (KC Engineering), Martin Stary (KC Engineering), Brad Shaw, P.E. (Highland Lakes Engineering), Sam Martin (Hill Country Economic Development Council), Vance Fields, Joe Don Dockery, Jim Henderson, Joe Freeman (Texas State Soil and Water Conservation Board), Duane Stueven (Llano County Commissioner), Pat Frain (Sunrise Beach Mayor), Sandra Overstreet (Llano River Advisory Panel), and Ron Moore (Llano County).

For the quarry and mine ordinance amendments, LCRA would like to acknowledge the stakeholder committee composed of the following: Dave Kithil (Burnet County Judge), Mike Clark (JM Huber Corporation), Wayne Brown (Central Texas Groundwater Conservation District), Mike Clark (Cold Spring Granite), Sam Martin (Hill Country Economic Development Council), Ken Prince (Capitol Aggregates), Charles Shell (City of Bertram), Bryce Darby (Chemical Lime Inc.), John Simmons, Leslie Hassell (Hanson), Jerry Gregg (Hanson and Texas Aggregates and Concrete Association), Phil Haag, Andy Carson (Cactus Canyon Quarry), Tommy Matthews (Westward Environmental), David Vaughn (City of Burnet), Ramsey Clinton, Sylvia Pope (City of Austin), Jane Marie Hurst (Hurst Capital Investments and Black Wolf Partners), Michael Steward (Texas Aggregates and Concrete Association), and Rollin MacRae (Texas Parks and Wildlife).

Thanks are also extended to the members of the Technical Manual peer review committee, whose comments and recommendations were most helpful in improving this manual. Peer review committee members who gave their advice and time included: Jon Beall (Save Barton Creek Association), Dave Fowler (Travis County), Greg Haley, P.E. (KC Engineering, Inc.), Tim Haynie, P.E. (Haynie Consulting, Inc.), Ken Manning, John Noell, P.E. (Urban Design Group), Murphy Parks (Freese and Nichols), Tony Plumlee, P.E. (Willis Environmental, Inc.), Brad

Shaw, P.E. (Highland Lakes Engineering), Martin Stary (KC Engineering, Inc.), Rick Wheeler, P.E. (Malone/Wheeler, Inc.), and David Venhuizen, P.E. From the quarry and mine perspective, we would like to thank Gary Nicholls (Westward Environmental) and Mike Clark (JM Huber).

Special thanks are extended to Dan Obenour, Blaine Linkous, and James Miertschin, P.E. (James Miertschin and Associates, Inc.), Jim Scaief, P.E. (Murfee Engineering, Inc.) and Michael Barrett, PhD, P.E. for their research, analysis, development of design techniques, and overall support throughout the technical manual development process.

Finally, we would like to express our gratitude to the Texas Commission on Environmental Quality (TCEQ) for permitting the Edwards Aquifer Technical Guidance Manual, 2005, to serve as the base document for this manual.

Foreword

The Highland Lakes and Colorado River are extremely important to the people of Central Texas, for the environment they provide and for the numerous economic and recreational opportunities they offer. Stormwater runoff typically sweeps trash, debris, sediment, nutrients and oil and grease from streets, parking lots, yards and construction sites. This is a result of human activity on the land.

As a steward of the Colorado River, the LCRA has a responsibility to protect and conserve the natural resources of the region. To meet that responsibility, LCRA's Board of Directors adopted the Water Quality Leadership Policy in 1988 (amended in December 2000) and two water quality protection ordinances in the early 1990's. Much has changed around the Highland Lakes since the water quality management program began. However, the one thing that remains constant is that pollutants carried by stormwater runoff continue to be a growing issue and concern for the water quality of the Highland Lakes and Colorado River as population and development increases throughout the basin.

In 2005, the two water quality protection ordinances were reviewed by staff, stakeholder groups were assembled, and public meetings were held in a year-long process that resulted in combining the ordinances into the Highland Lakes Watershed Ordinance (HLWO). The HLWO applies to portions of Travis, Burnet and Llano counties, as seen in Appendix 1.1.1. Included in the consolidation is a shift in focus to tributary and creek protection as well as lake water quality protection. Many changes were made to reflect the knowledge gained over the last 15 years, evolving stormwater management technologies, better science, and experience implementing a water quality protection ordinance. In early 2007, LCRA adopted quarry and mine ordinance amendments to provide water quality protection for this industry. To accommodate these rules, the technical manual includes guidance for quarry and mine activity.

The LCRA Technical Manual guides developers, quarry and mine operators, engineers, geologists, and other interested parties on specifically how to comply with the Highland Lakes Watershed Ordinance. The manual provides options for meeting the ordinance standards with Best Management Practices (BMPs). Developers have the option of choosing from the BMPs offered in the manual, or can propose other approaches and technologies, as long as the ordinance standards are met. This is the fifth edition of the LCRA Technical Manual.

For more information contact: LCRA, Water Resource Protection – L421, P.O. Box 220, Austin, Texas 78767-0220, 1-800-776-5272, ext. 2324 or (512) 473-3200, ext. 2324.

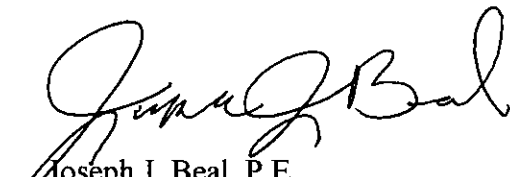

Joseph J. Beal, P.E.
General Manager

TABLE OF CONTENTS

DESIGN SPREADSHEET MODEL	FRONT POCKET
STORMWATER CREDITS FOR INDIVIDUAL LOTS MODEL	FRONT POCKET
TEXAS HILL COUNTRY LANDSCAPE OPTION.....	FRONT POCKET
DREDGE AND FILL STANDARDS HANDBOOK.....	FRONT POCKET
HIGHLAND LAKES WATERSHED ORDINANCE HANDBOOK ...	FRONT POCKET

SECTION I – DEVELOPMENT

CHAPTER 1 PERMIT REQUIREMENTS AND PROCEDURES

	Page
1.1 INTRODUCTION.....	1-1
1.2 EXEMPTIONS.....	1-3
1.3 WRITTEN NOTIFICATION REQUIRED	1-3
1.4 DEVELOPMENT PERMIT.....	1-4
1.4.1 Overview	1-4
1.4.2 Permit Process Flow Chart	1-5
1.4.3 Development Permit Application Procedures	1-6
1.4.4 Permit Amendment.....	1-8
1.4.5 Pre-development/ Concept Plan Meeting Procedures.....	1-8
1.4.6 Financial Security for Erosion & Sedimentation Controls.....	1-8
1.4.7 Notice of Application for Development Permits	1-9
1.4.8 Comments.....	1-9
1.4.9 Public Meetings	1-9
1.4.10 Master Plan.....	1-9
1.4.11 Variances	1-9
1.4.12 Appeals.....	1-10
1.5 BMP MAINTENANCE PERMIT.....	1-10
1.5.1 Overview	1-10
1.5.2 Procedures.....	1-10
1.6 GENERAL UTILITY PERMIT	1-11
1.6.1 Overview	1-11
1.6.2 Procedures	1-11
1.7 PRELIMINARY AND FINAL PLAT REVIEW.....	1-12
1.7.1 Overview	1-12
1.7.2 Procedures	1-12

CHAPTER 2 MEETING WATER QUALITY MANAGEMENT PERFORMANCE STANDARDS

2.1 INTRODUCTION.....	2-1
2.2 PRE DEVELOPMENT PLANNING	2-2
2.3 WATER QUALITY MANAGEMENT (BMP DESIGN AND ASSESSMENT)	2-2
2.3.1 Alternate Standards	2-2
2.3.2 Stormwater Credits.....	2-4

2.3.3	<i>Water Quality BMP Sizing</i>	2-8
2.4	BUFFER ZONES	2-18
2.4.1	<i>Buffer Zone Technical Requirements</i>	2-20
2.5	CONSTRUCTION- PHASE EROSION AND SEDIMENT CONTROL PLANNING ..	2-22
2.6	WATER QUALITY EDUCATION	2-26

CHAPTER 3 EROSION AND SEDIMENT CONTROL BEST MANAGEMENT PRACTICES

3.1	INTRODUCTION	3-1
3.2	EROSION CONTROL BMPs	3-1
3.2.1	<i>Interceptor Swale</i>	3-5
3.2.2	<i>Diversion Dikes</i>	3-7
3.2.3	<i>Pipe Slope Drain</i>	3-10
3.2.4	<i>Channel Stabilization</i>	3-12
3.2.5	<i>Outlet Stabilization</i>	3-15
3.2.6	<i>Level Spreaders</i>	3-18
3.2.7	<i>Subsurface Drains</i>	3-22
3.2.8	<i>Vegetation</i>	3-26
3.2.9	<i>Irrigation</i>	3-29
3.2.10	<i>Cedar Mulch</i>	3-30
3.2.11	<i>Blankets and Matting</i>	3-31
3.2.12	<i>Organic Compost Mulch</i>	3-44
3.2.13	<i>Hydraulic Mulch</i>	3-47
3.2.14	<i>Sod</i>	3-48
3.2.15	<i>Dust Control</i>	3-53
3.3	SEDIMENT CONTROL BMPs	3-54
3.3.1	<i>General Guidelines</i>	3-54
3.3.2	<i>Temporary Construction Entrance/Exit</i>	3-56
3.3.3	<i>Silt Fence</i>	3-59
3.3.4	<i>Triangular Sediment Filter Dikes</i>	3-63
3.3.5	<i>Rock Berms</i>	3-67
3.3.6	<i>High Service Rock Berms</i>	3-70
3.3.7	<i>Brush Berms</i>	3-73
3.3.8	<i>Check Dams</i>	3-77
3.3.9	<i>Vegetative Buffers</i>	3-80
3.3.10	<i>Inlet Protection</i>	3-81
3.3.11	<i>Stone Outlet Sediment Trap</i>	3-85
3.3.12	<i>Sediment Basins</i>	3-88
3.3.13	<i>Fiber Rolls</i>	3-91
3.3.14	<i>Dewatering Operations</i>	3-93
3.3.15	<i>Spill Prevention and Control</i>	3-96
3.3.16	<i>Creek Crossings</i>	3-101
3.3.17	<i>Concrete Washout Areas</i>	3-107

CHAPTER 4 PERMANENT STRUCTURAL BEST MANAGEMENT PRACTICES (WATER QUALITY TREATMENT)

4.1	INTRODUCTION.....	4-1
4.2	WATER QUALITY TREATMENT BMP GUIDELINES.....	4-2
4.2.1	<i>General Design Guidelines.....</i>	4-2
4.2.2	<i>Bioretention Basin</i>	4-6
4.2.3	<i>Extended Detention Basin.....</i>	4-11
4.2.4	<i>Sand Filter Basin</i>	4-15
4.2.5	<i>Wet Basins.....</i>	4-21
4.2.6	<i>Retention/ Irrigation</i>	4-31
4.2.7	<i>Vegetative Filter Strips</i>	4-37
4.2.8	<i>Stormwater Infiltration Devices</i>	4-46
4.3	STORMWATER CREDITS.....	4-53
4.3.1	<i>Porous Pavement/ Pervious Pavers Credit.....</i>	4-53
4.3.2	<i>Rainwater Harvesting/ Cistern Credit.....</i>	4-59
4.3.3	<i>Soil Amendment and Conservation Landscaping Credit.....</i>	4-66
4.3.4	<i>Disconnection of Rooftop Runoff Credit.....</i>	4-73
4.3.5	<i>Natural Area Preservation Credit</i>	4-75
4.3.6	<i>Wet Vault Credit</i>	4-76
4.3.7	<i>Dealing with Multiple Credits</i>	4-77
4.4	STORMWATER MANAGEMENT FOR INDIVIDUAL LOTS	4-78
4.5	STORMWATER MANAGEMENT FOR RIDGELINE/ISOLATED LOTS.....	4-80

CHAPTER 5 PERMANENT BMP MAINTENANCE GUIDELINES

5.1	MAINTENANCE PLAN.....	5-1
5.2	GENERAL GUIDELINES.....	5-1
5.3	BASIN DE-WATERING	5-2
5.4	SEDIMENT DISPOSAL	5-3
5.5	BMP MAINTENANCE REQUIREMENTS	5-3
5.5.1	<i>Detailed Inspections and General Maintenance.....</i>	5-3
5.5.2	<i>General Site Maintenance.....</i>	5-4
5.5.3	<i>Inspection and Maintenance of Water Quality Basin BMPs</i>	5-5
5.6	BMP MAINTENANCE PERMIT.....	5-6

CHAPTER 6 DREDGE AND FILL STANDARDS

6.1	PREFACE	6-1
6.2	DEFINITIONS	6-2
6.3	DREDGE AND FILL ACTIVITIES	6-3
6.4	OTHER REGULATIONS.....	6-3
6.5	HIGHLAND LAKES ELEVATION LEVELS	6-4
6.6	PROPERTY OWNERSHIP	6-4
6.6.1	<i>Privately Owned Land</i>	6-4
6.6.2	<i>Publicly Owned Land.....</i>	6-4

6.7	LAND RECLAMATION	6-5
6.8	WATER QUALITY PROTECTION.....	6-5
6.9	ENSURING NAVIGABILITY OF WATERS	6-6
6.10	SHORELINE PROTECTION TECHNIQUES	6-6
	6.10.1 Use of retaining walls and riprap to stabilize eroded shorelines.....	6-8
6.11	ENFORCEMENT OF DREDGE AND FILL STANDARDS	6-12
6.12	U.S. ARMY CORPS OF ENGINEERS REQUIREMENTS	6-12
6.13	LAKEWIDE PERMIT	6-13

SECTION II – QUARRY AND MINE ACTIVITY

CHAPTER 1 PERMIT REQUIREMENTS AND PROCEDURES

1.1	INTRODUCTION.....	1-1
1.2	EXEMPTIONS.....	1-1
1.3	WRITTEN NOTIFICATION REQUIRED	1-1
1.4	QUARRY/MINE CERTIFICATION	1-2
1.5	QUARRY/MINE PERMIT.....	1-2

CHAPTER 2 MEETING WATER QUALITY MANAGEMENT PERFORMANCE STANDARDS

2.1	INTRODUCTION.....	2-1
2.2	PRE QUARRY/MINE PLANNING	2-2
2.3	WATER QUALITY MANAGEMENT	2-2
	2.3.1 Stormwater from Project Area Not Draining to Pit.....	2-3
	2.3.2 Stormwater from Project Area Draining to Pit	2-3
	2.3.3 Other Local State and Federal Regulations	2-4
	2.3.4 Potential Submittals to LCRA.....	2-5
	2.3.5 Groundwater Quality Protection.....	2-8
2.4	BUFFER ZONES	2-10
	2.4.1 Buffer Zone Technical Requirements.....	2-12
2.5	EROSION AND SEDIMENT CONTROL	2-13
2.6	REPORTING	2-16

GLOSSARY.....	G-1
---------------	-----

BIBLIOGRAPHY	B-1
--------------------	-----

APPENDIX

1.1	LCRA HIGHLAND LAKES WATERSHED ORDINANCE
	1.1.1 Ordinance Watershed Map
1.2	DEVELOPMENT AND QUARRY/MINE PERMIT APPLICATION FORM
1.3	FEE SCHEDULE

- 1.4 “NOTIFICATION OF NO PERMIT REQUIRED” FORM**
 - 1.4.1 Dredge and Fill Standards Checklist*
- 1.5 DEVELOPMENT PERMIT SUBMITTAL REQUIREMENTS**
 - 1.5.1 Administrative Completeness Checklist*
- 1.6 MASTER PLAN SUBMITTAL REQUIREMENTS**
- 1.7 BMP MAINTENANCE PERMIT SUBMITTAL REQUIREMENTS**
 - 1.7.1 BMP Maintenance Permit Application*
 - 1.7.2 Permanent BMP Inspection Checklist Example- Water Quality Basin*
 - 1.7.3 Permanent BMP Inspection Checklist Example- Vegetative*
- 1.8 UTILITY GENERAL PERMIT SUBMITTAL REQUIREMENTS**
- 1.9 PRELIMINARY PLAN SUBMITTAL REQUIREMENTS**
- 1.10 FINAL PLAT SUBMITTAL REQUIREMENTS**
- 1.11 PLAT NOTES**
- 1.12 LETTER OF CREDIT EXAMPLE FORMS**
- 1.13 NEWSPAPER NOTICE EXAMPLE**
- 1.14 PROJECT SIGN NOTICE**
 - 1.14.1 Mailed Notice Example- Development Permit*
 - 1.14.2 Mailed Notice Example- Master Plan*
- 1.15 INSPECTION PROCEDURES**
- 1.16 PRE-CONSTRUCTION MEETING HANDOUT- RESPONSIBLE PARTY DESIGNATION**
- 2.1 EXAMPLE ALTERNATE DEVELOPMENT STANDARDS- SINGLE FAMILY DEVELOPMENT**
 - 2.1.1 1/5th acre lot using stormwater credits to gain alternate standards compliance*
 - 2.1.2 1/2 acre lot using stormwater credits to gain alternate standards compliance*
- 2.2 EXAMPLE BMP DESIGN- SINGLE FAMILY SUBDIVISION PROJECT**
- 2.3 EXAMPLE BMP DESIGN- LARGE COMMERCIAL DEVELOPMENT PROJECT**
- 2.4 HYDROLOGY AND HYDRAULICS REFERENCE TABLES**
- 2.5 PRE DEVELOPMENT PLANNING**
- 2.6 BUFFER ZONES**
- 2.7 CONSTRUCTION-PHASE EROSION AND SEDIMENT CONTROL**
 - 2.7.1 Erosion and Sediment Control Handouts (See www.lcra.org for Spanish version)*
 - 2.7.2 Erosion and Sediment Control General Notes*
 - 2.7.3 Notes for Construction in Creeks*
- 2.8 SITE CHARACTERISTICS FOR HIGH EROSION POTENTIAL**
- 2.9 WATER QUALITY EDUCATION**
- 2.10 INDIVIDUAL LOT BEST MANAGEMENT PRACTICE DETAILS**
 - 2.10.1 Porous Pavement and Pavers*
 - 2.10.2 Rain Garden*
 - 2.10.3 Dry Well*
 - 2.10.4 Conservation and Landscape Guidelines*

TABLES

SECTION 1 – DEVELOPMENT

- 1-1 SUMMARY OF PROJECT REQUIREMENTS 1-2**
- 2-1 SUMMARY OF PERFORMANCE STANDARDS 2-1**

2-2	STORMWATER CREDITS	2-4
2-3	ROOFTOP DISCONNECTION IMPERVIOUS COVER CREDIT.....	2-7
2-4	IMPERVIOUS COVER ASSUMPTIONS FOR RESIDENTIAL TRACTS.....	2-9
2-5	PERMANENT BMP SUMMARY	2-10
2-6	BMP POLLUTION MANAGEMENT PERFORMANCE.....	2-11
2-7	PERMANENT BMP SUITE SUMMARY	2-12
2-8	RUNOFF VOLUME	2-13
2-9	SECONDARY BMP SIZING GUIDANCE	2-15
2-10	DESIGN GUIDANCE FOR SOIL PERMEABILITY	2-15
2-11	GENERAL CHARACTERISTICS OF SOILS IN THE HIGHLAND LAKES WATERSHED	2-16
2-12	SITE CHARACTERISTICS FOR HIGH EROSION POTENTIAL CHECKLIST	2-24
2-13	EROSION CONTROL SELECTION GUIDANCE.....	2-25
3-1	SUMMARY OF TEMPORARY EROSION CONTROL PRACTICES	3-2
3-2	RANGES OF SHEAR BY DEPTH AND SLOPE	3-4
3-3	TEMPORARY SEEDING FOR BURNET, TRAVIS AND LLANO COUNTIES.....	3-28
3-4	PERMANENT SEEDING FOR BURNET, TRAVIS AND LLANO COUNTIES.....	3-29
3-5	TYPE A- SLOPES 3:1 OR FLATTER- CLAY SOILS	3-34
3-6	TYPE B- SLOPES 3:1 OR FLATTER- SANDY SOILS	3-35
3-7	TYPE C- SLOPES STEEPER THAN 3:1- CLAY SOILS.....	3-36
3-8	TYPE D- SLOPES STEEPER THAN 3:1- SANDY SOILS.....	3-37
3-9	TYPE E- SHEAR STRESS RANGE 0-96 PASCAL.....	3-38
3-10	TYPE F- SHEAR STRESS RANGE 0-192 PASCAL	3-39
3-11	TYPE G- SHEAR STRESS RANGE 0-287 PASCAL	3-40
3-12	TYPE H- SHEAR STRESS RANGE 0-383 PASCAL	3-40
3-13	SEEDING FOR EROSION CONTROL: CLAY OR TIGHT SOILS	3-41
3-14	SEEDING FOR EROSION CONTROL: SANDY OR LOOSE SOILS.....	3-41
3-15	COMPOST BLANKET PARAMETERS.....	3-45
3-16	COMPOST BLANKET APPLICATION RATES.....	3-46
3-17	GUIDELINES FOR SELECTION OF SEDIMENT CONTROL BMPs	3-55
3-18	SILT FENCE SPACING ON SLOPING SITES	3-56
3-19	ROCK BERM SPACING ON CHANNELS.....	3-56
4-1	STORMWATER CREDITS FOR INDIVIDUAL LOTS	4-79
6-1	RIPRAP SIZE FOR WAVE PROTECTION.	6-7
6-2	WAVE RUN-UP HEIGHT FOR ANGULAR ROCK RIPRAP	6-7

SECTION II – QUARRY AND MINE ACTIVITY

2-1	SUMMARY OF PERFORMANCE STANDARDS	2-1
2-2	EROSION CONTROL SELECTION GUIDANCE.....	2-15

FIGURES

SECTION I – DEVELOPMENT

1-1	PERMIT PROCESS FLOW CHART.....	1-5
-----	--------------------------------	-----

2-1	RAINWATER COLLECTION CREDIT	2-6
2-2	BUFFER ZONE SCHEMATIC	2-20
3-1	SCHEMATIC DIAGRAM OF AN INTERCEPTOR SWALE.....	3-6
3-2	SCHEMATIC OF A DIVERSION DIKE	3-9
3-3	SCHEMATIC DIAGRAM OF A SLOPE DRAIN.....	3-11
3-4	RIPRAP SIZE SELECTION.....	3-14
3-5	RIPRAP OUTLET DESIGN.....	3-16
3-6	LEVEL SPREADER SCHEMATIC & PERSPECTIVE.....	3-20
3-7	LEVEL SPREADER LIP OPTION	3-21
3-8	EFFECT OF SUBSURFACE DRAIN	3-22
3-9	SUBSURFACE DRAINAGE PATTERNS	3-23
3-10	SURFACE INLETS FOR SUBSURFACE DRAINS	3-25
3-11	SUBSURFACE DRAIN ENVELOPE	3-26
3-12	PLANTING DATES FOR BURNET, TRAVIS AND LLANO COUNTIES.....	3-28
3-13	RAINFALL /ET DATA FOR AUSTIN	3-30
3-14	INITIAL ANCHOR TRENCH FOR BLANKETS AND MATS.....	3-42
3-15	TERMINAL ANCHOR TRENCH FOR BLANKETS AND MATS.....	3-42
3-16	PROPER SOD INSTALLATION TECHNIQUES	3-51
3-17	INSTALLATION OF SOD IN A CHANNEL	3-52
3-18	SCHEMATIC OF TEMPORARY CONSTRUCTION ENTRANCE/ EXIT.....	3-57
3-19	CROSS SECTION OF CONSTRUCTION ENTRANCE/ EXIT	3-57
3-20	SCHEMATIC OF A SILT FENCE INSTALLATION	3-60
3-21	J HOOK PLACEMENT DETAILS	3-61
3-22	SCHEMATIC OF A TRIANGULAR FILTER DIKE.....	3-66
3-23	SCHEMATIC DIAGRAM OF A ROCK BERM	3-69
3-24	SCHEMATIC DIAGRAM OF A HIGH SERVICE ROCK BERM.....	3-71
3-25	SCHEMATIC DIAGRAM OF A BRUSH BERM.....	3-75
3-26	DIAGRAM OF A ROCK CHECK DAM.....	3-78
3-27	FILTER FABRIC INLET PROTECTION	3-83
3-28	WOODEN WEIR CURB INLET PROTECTION.....	3-84
3-29	SCHEMATIC DIAGRAM OF A SEDIMENT TRAP.....	3-87
3-30	SCHEMATIC OF A SEDIMENT BASIN	3-89
3-31	CREEK CROSSING.....	3-102
3-32	TYPICAL TEMPORARY FORD CROSSING	3-104
3-33	TYPICAL TEMPORARY CULVERT CROSSING.....	3-105
3-34	TYPICAL TEMPORARY BRIDGE CROSSING.....	3-106
3-35	SCHEMATICS OF CONCRETE WASHOUT AREAS.....	3-108
4-1	BIORETENTION BASIN WITH SAND FILTER OVERFLOW SCHEMATIC.....	4-10
4-2	EXTENDED DETENTION BASIN SCHEMATIC	4-14
4-3	SAND FILTER SYSTEM SCHEMATIC	4-18
4-4	DETAIL OF SEDIMENTATION RISER PIPE	4-19
4-5	SAND BED PROFILE SCHEMATIC	4-20
4-6	SCHEMATIC OF A WET POND.....	4-27
4-7	SCHEMATIC DIAGRAMS OF WET BASIN OUTLETS.....	4-28
4-8	SCHEMATIC OF A CONSTRUCTED WETLAND.....	4-30
4-9	RETENTION/ IRRIGATION VOLUME PARTITION	4-32

4-10	SPRINKLER HEAD DETAIL	4-36
4-11	STAIR-STEP HILLS OF THE GLEN ROSE FORMATION	4-38
4-12	RISER/TREAD SEQUENCE OF STAIR-STEPPED TOPOGRAPHY.....	4-38
4-13	EXAMPLE OF STAND ALONE VEGETATIVE FILTER STRIP APPLICATION....	4-39
4-14	NATURAL VEGETATIVE FILTER STRIP	4-41
4-15	ENGINEERED VEGETATIVE FILTER STRIP	4-43
4-16	ENGINEERED VEGETATIVE INFILTRATION STRIP	4-45
4-17	INFILTRATION BASIN SCHEMATIC	4-49
4-18	INFILTRATION TRENCH SCHEMATIC	4-52
4-19	SCHEMATIC OF PERMEABLE CONCRETE WITH UNDERDRAIN INSTALLATION	4-58
4-20	COMPLEX WATER HARVESTING SYSTEM WITH ROOF CATCHMENT, GUTTER, DOWNSPOUT AND STORAGE TANK	4-62
4-21	COMPLEX WATER HARVESTING SYSTEM WITH ROOF CATCHMENT, GUTTER, DOWNSPOUT AND STORAGE TANK	4-63
4-22	STANDPIPE FIRST FLUSH DIVERTER.....	4-64
4-23	STANPIPE WITH BALL VALVE	4-64
4-24	BOX ROOF WASHER.....	4-65
4-25	SCHEMATIC OF A DRY WELL	4-74
6-1	SLOPE PROTECTION USING ROCK RIPRAP.....	6-9
6-2	VERTICAL PROTECTION USING RETAINING WALL	6-9
6-3	FAILED SHORELINE PROTECTION SYSTEMS.....	6-10
6-4	DETERMINING THE CUBIC YARDS OF DREDGED MATERIAL.	6-11
6-5	CUT SLOPE FOR DREDGED AREA	6-11

SECTION II – QUARRY AND MINE ACTIVITY

2-1	BUFFER ZONE SCHEMATIC	2-11
-----	-----------------------------	------

Chapter 1

Permitting Requirements and Procedures

1.1 Introduction

This Chapter discusses the types of permits required for development activities under the LCRA Highland Lakes Watershed Ordinance (to read the text of the Ordinance, and find the Ordinance definition of development and other terms, see Appendix 1.1). A development permit is required for land development activities unless the proposed activities fall in the following Exemption or Written Notification Required Categories. If a development permit includes the construction of permanent water quality management BMPs, a BMP maintenance permit is required to ensure proper maintenance of the BMPs. Public Utilities may obtain a General Utility Permit in lieu of a Development Permit for routine utility construction or maintenance. LCRA may also review preliminary plans and final plats in conjunction with cities and counties within the ordinance jurisdiction. See Table 1-1 for a summary of project permitting requirements.

**TABLE 1-1
SUMMARY OF PROJECT REQUIREMENTS
As Designated with “X”**

If Your Project is:	Notification only No Permit Required	Permit	Pre Planning ¹	WQ Volume ²	Alt Standards ³	Buffer Zones ⁴	Temp ESC ⁵	LID ⁶
Development <10,000 sq ft. Impervious Cover & < 1acre disturbance	X						X	
SF Home >10,000 sq ft. Impervious Cover & < 1 acre disturbance	X						X w/buffer guidelines	
SF Development<15% gross Impervious Cover, CD ⁷ <20% Impervious Cover		X Fast-Track Permit ⁸	X Greater than 20 acres		X	X	X	X
SF Development >15% gross		X	X Greater than 20 acres	X		X	X	X
Commercial < 3 acres		X Fast-Track Permit		Optional	X	X	X	X
Commercial > 3 acres		X	X	X		X	X	X

1. Pre-development planning – Meeting with LCRA and development team at concept plan stage – Ordinance Section 5(a)
2. Water quality volume – Runoff volume to be captured based on the one-year storm Ordinance Section 5(b)
3. Alternate Standards – Use of Vegetative Filter Strips, no storm drain, no curb and gutter and sheet flow should be used to achieve compliance in Ordinance Section 5(b)
4. Buffer Zones – Creek protection based on Ordinance Section 5(c)
5. Temporary Erosion and Sedimentation controls – Erosion control per TCEQ SWPPP and LCRA Technical Manual in Ordinance Section 5(d)
6. LID – Low impact development techniques to achieve compliance are available as an option to limit structural control use and/or size.
7. CD – Cluster Development
8. Fast Track Permit – Permit issuance within 30 calendar days of administrative completeness.

1.2 Exemptions

The following are exempt from the provisions of this Ordinance and are not required to file an application for or obtain a permit pursuant to this Ordinance.

- 1.2.1 Development within a Political Subdivision that has adopted and maintains in effect LCRA's Ordinance and enters into an interlocal agreement with LCRA or
- 1.2.2 Development within a Political Subdivision that has adopted an ordinance that LCRA determines provides for management of stormwater pollution that is equal to or greater than that provided by the LCRA Ordinance and the Political Subdivision enters into an interlocal agreement with LCRA agreeing that the LCRA Ordinance shall apply to any Development that receives an exemption, waiver or variance from the Municipal Ordinance if such exemption, waiver or variance will cause significant stormwater runoff pollution; or
- 1.2.3 Dredge and fill projects for shoreline stabilization as defined in the ordinance and provided that the project complies with the LCRA Dredge/Fill Standard found in Chapter 6 of this manual
- 1.2.4 Agricultural Activities, which are defined as all activities associated with the production of livestock or use of the land for planting, growing, cultivating and harvesting crops, or participating in a wildlife management plan. The intent of this exemption is to minimize the regulatory impact on bona fide agricultural activities. Wholesale clearing of land under agricultural auspices prior to land development of the land may result in severe erosion and sedimentation. If an application for development is submitted for recently cleared land, permit approval may be delayed until the site is stabilized. LCRA encourages the use of soil conservation techniques including phasing of brush control and clearing activities to minimize the extent of disturbed areas, use of brush berms, terracing and stock tanks for sediment control, mulching of brush to protect against erosion, prompt re-establishment of vegetation and other practices that minimize the erosion of soil. See Chapter 3 for discussion of erosion control measures. Additional soil conservation resources may be found through the LCRA Creekside Conservation Program and through the National Resource Conservation Service (NRCS).

1.3 Written Notification Required

The following Development or Redevelopment activities will not require a development permit provided that written notification of the activities is provided to LCRA and erosion and sedimentation controls are installed and maintained throughout the construction process in accordance with Chapters 2 and 3 of this Manual. Written Notification may be made by letter or by submission of the "No Permit Required Notification" form found in Appendix 1.4. In the written notification, the applicant shall demonstrate how the activity meets one or more of the conditions listed below. A site plan, plat, and erosion and sedimentation control plan may be required as documentation that the activities fall within the listed conditions.

- 1.3.1 Development or Redevelopment located on a property that obtained final plat approval from a governmental entity prior to February 1, 1990, in the Lake Travis watershed in Travis County, or March 19, 1992, in Llano County or Burnet County in the Colorado River Watershed. Provided that a property has not been replatted after February 1, 1990 in Travis County and March 19, 1992 in Burnet and Llano counties, or
- 1.3.2 Development, including a Single-family Residence, that creates less than 10,000 square feet of Impervious Cover and disturbs less than one acre of land,
- 1.3.3 Development of a Single-family Residence that creates more than 10,000 square feet of Impervious Cover and disturbs less than one acre of land provided that the Site complies with the downstream buffer guidelines found in the Chapter 2 of this Manual.
- 1.3.4 Existing Development, that is any development completed prior to the effective date of the LCRA Nonpoint Source Pollution (NPS) Control Ordinances (Feb. 1, 1990 in Travis County, March 19, 1992 in Burnet and Llano Counties) or any development completed in compliance with LCRA NPS Ordinances.
- 1.3.5 Redevelopment provided that the cumulative increase in Impervious Cover is less than 10,000 square feet and less than one acre of land is disturbed. Redevelopment is defined as any rebuilding, renovation, revisions, remodel, reconstruction of an Existing Development or redesign of an Existing Development occurring after February 1, 1990, in the Lake Travis Watershed in Travis County, or March 19, 1992 in Llano County or Burnet in the Colorado River Watershed as reflected in Attachment 2, and which does not cumulatively increase Impervious Cover by 10,000 square feet or more.
- 1.3.6 Dredge and Fill activities that dredge more than 500 cubic yards or disturb more than 500 linear feet of shoreline provided that activities comply with LCRA Dredge/Fill Standards.
- 1.3.7 Mine and/or Quarry activities that creates less than one acre of Impervious Cover and will disturb five acres or less of land.

1.4 *Development Permit*

1.4.1 Overview:

This section discusses the procedures for obtaining a development permit. Single Family Residential development sites greater than 20 acres in area and all commercial development sites greater than three acres in area require a pre-development/concept plan meeting prior to submittal of a permit application. For these sites, a Development permit application can only be submitted after the completion of this task. Sites that will be developed in phases will require submittal and approval of a Master Plan prior to submittal of a permit application. Procedures for pre-development meetings and Master Plan review are found in this chapter. Please refer to Figure 1-1 for a permit process flow chart.

1.4.2 Permit Process Flow Chart

Figure 1-1

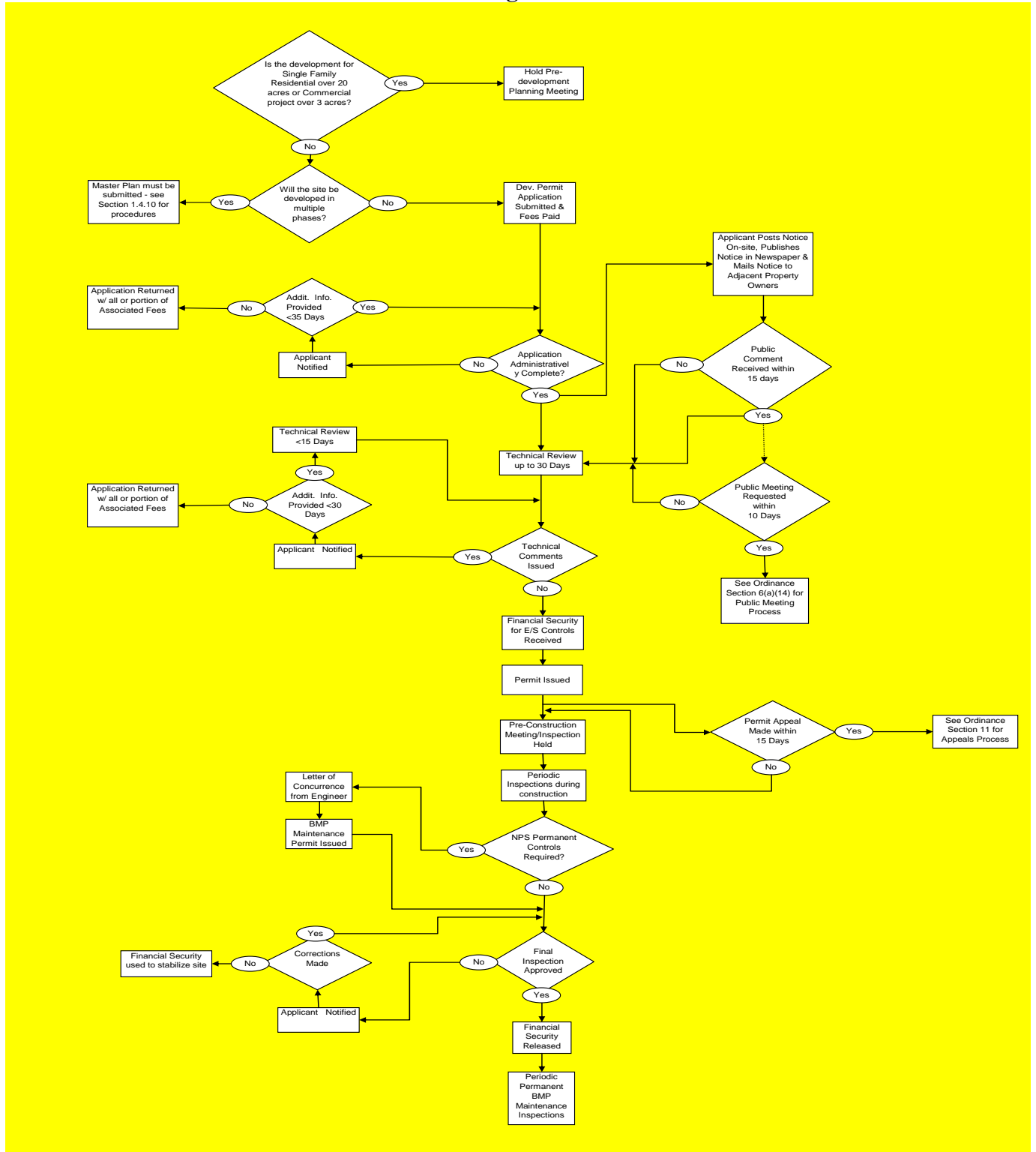

1.4.3 Development Permit Procedures

- a. Contact LCRA to schedule a predevelopment/concept plan meeting if applicable. Applicability of master plan requirements will be determined at this meeting.
- b. Submit completed application form (Appendix 1.2) and supporting documents and pay fees. See Appendix 1.3 for fee schedule.
- b. LCRA determines if the application is administratively complete according Development Permit Submittal Requirements found in Appendix 1.5 and 1.5.1.
- c. If the application is incomplete, LCRA will contact the applicant within 10 calendar days. If the applicant does not submit the required information within 35 calendar days, the application and a portion of the fees will be returned to the applicant.
- d. If the application is complete, the 30 calendar day technical review period will begin and the applicant shall post notice on the property, publish a notice in a local newspaper with general circulation in the area and mail notice to adjacent property owners. If the proposed development falls within the jurisdiction of a municipality, notice may also be mailed to the municipality. Interested citizens will have 15 calendar days from the date the notice is published in the newspaper to respond in writing to the LCRA regarding the application. See Appendix 1.13 and 1.14 for Notice Examples and refer to Ordinance Section 6(a) (12) for additional information on the notice requirements.
- e. If additional information is required during the 30 calendar day technical review period, the applicant will be notified and given 30 calendar days to respond. If the additional information is not provided within the 30 calendar day period, the application and all or part of the fees may be returned to the applicant. The applicant may request an extension of time to provide the information requested by staff during the administrative or technical review. Requests for extensions shall be in writing and shall explain in detail the need for additional time. Such requests shall be approved in writing by LCRA, which approval shall not be unreasonably withheld except that in no event shall the cumulative amount of time granted to an Applicant exceed six months from the date that the application for a Permit was filed. If an extension expires without action, the Application is considered withdrawn and the Applicant must resubmit a new Application with the appropriate fees.
- f. If the additional information is provided, the technical review period will be extended by up to 15 calendar days to review the additional information.
- g. Informal meetings with the applicant to resolve issues may occur at any time throughout the technical review period.

- h. When the applicant has demonstrated compliance with the standards of the ordinance, a financial security for erosion and sedimentation controls (ESC) as described in Section 1.4.6 must be posted. If the applicant fails to demonstrate compliance with the ordinance standards, or fails to respond to requests for additional information, the application is considered to be denied.
- i. Following the completion of the above items and upon receipt and acceptance of financial security for ESC, a Development Permit will be issued.
- j. A 15 calendar day appeal period will begin on the day the permit is issued or denied. See Section 1.4.12 for appeals procedures.
- k. A pre-construction inspection must be scheduled after permit issuance and prior to commencing construction. ESC must be installed prior to the meeting. The applicant will coordinate a pre-construction inspection with the applicant, LCRA inspector, design engineer, contractor, and other appropriate personnel. The person responsible for installation and maintenance of ESC will be designated at this time; and permit conditions and inspection procedures discussed. Refer to Appendix 1.15 for Inspection Procedures.
- l. Construction may begin after the pre-construction inspection, subject to approval of the erosion and sedimentation controls and applicable permit conditions. If an appeal is filed, construction must be suspended until the appeal is resolved.
- m. During construction, there will be on-going inspections by LCRA inspectors throughout the construction phase. Corrective actions to address ESC effectiveness, including the installation of additional ESCs, may be required by the inspector. Deviations from approved plans may require a permit amendment. Minor adjustments to ESC locations will not require a permit amendment, but must be documented by the responsible party. If the permit includes construction of permanent BMPs, additional inspections may be required. The responsible person must contact LCRA to perform these inspections
- n. When construction is complete, a final inspection is required to verify that the permit conditions have been fulfilled. Prior to the inspection, the project engineer must provide written certification that the drainage system and any permanent BMPs were constructed in accordance with the permit conditions and ordinance requirements. LCRA will then coordinate the final inspection with appropriate personnel.
- o. Upon satisfactory completion of the final inspection, including completion of all required BMPs and site stabilization, the permittee's financial security will be released. If the permit includes construction of permanent BMPs, a BMP Maintenance Permit must be obtained prior to release of financial security. See Section 1.5 for BMP Maintenance Permit procedures.

- p. When compliance with the Development permit has been established and a BMP Maintenance Permit has been issued, maintenance of the BMP(s) shall commence in accordance with the approved Maintenance Permit

1.4.4 Permit Amendment

If modifications to a permitted project are necessary, a permit amendment may be requested. The request shall be made in writing to the LCRA and must include an amended set of construction plans, an amended report identifying items from the application packet that will be changed from the original plans/report and a permit amendment fee.

LCRA shall take no more than 15 days to review and comment on the proposed amendment. If supplemental information is required, the permittee shall provide the information within 10 days of the request. If the information is not provided the request will be considered withdrawn.

Once the supplemental information is provided by the permittee, LCRA will approve, deny or revise the permit amendment request. Appeal of the decision will be processed according to the procedures in Section 1.4.12.

1.4.5 Pre-development/Concept Plan Meeting Procedures.

This meeting is intended to provide an initial review of the proposed development, to offer constructive comments regarding the site design and to explore options to enhance water quality management. The applicant should contact LCRA to arrange the meeting in the preliminary phases of site layout and design. The meeting shall be attended by the applicant or designated representative and the design engineer and other members of the design team. The applicant should bring a site layout plan, topographic map and floodplain maps, aerial photographs and other pertinent information to the meeting. The meeting will focus on the land plan, slopes, buffers, and water quality management practices, and may include a site investigation. The objective of the meeting is to assess the desired development configuration and to offer constructive guidance regarding appropriate water quality management strategies for the site. After the meeting, LCRA will provide a letter to the applicant confirming that the meeting has been held.

1.4.6 Financial Security for Erosion and Sedimentation Controls.

Approval of a development permit application is contingent upon financial security for ESC in an amount which provides for the implementation of temporary and permanent ESC, in accordance with the permit and any other provision of the Ordinance. Financial security may be in the form of an irrevocable letter of credit acceptable to LCRA, or a cashier's check. The amount of the security shall not be less than 100 percent of the said costs, including subsidiary items such as watering, mulch, etc. as estimated by the applicant's engineer and approved by LCRA. The irrevocable letter of credit shall be released after site stabilization, engineer's certification and approval of the BMP

Maintenance Permit by LCRA. The letter of credit shall be in the form found in Appendix 1.12. The minimum duration for a letter of credit is three (3) years. Contact LCRA to discuss alternate arrangements prior to submitting the letter for approval.

1.4.7 Notice of the Application for Development Permits.

During the technical review period described in Section 1.4.3 the applicant shall notify the public and adjacent property owners in accordance with Ordinance Section 6(a) (12).

Posted and Published Notice. The notice may be posted and published at any time during the technical review period; however, the technical review period will be extended to allow for the 15 calendar day comment period if the notice is posted more than 15 days after submittal of the application. See Appendix 1.13 for an example Notice.

Sign. The Applicant shall post a sign at the site within 5 days of notification of an administratively complete application. LCRA will provide the sign(s) to the applicant.

Mailed Notice. The applicant must coordinate the posting/published public notice with the mailed notice to ensure a uniform comment period. An example mailed notice form can be found in Appendix 1.14. In the event that the notice dates do not coincide, the comment period shall extend 15 calendar days from the last notice.

1.4.8 Comments.

Written comments concerning the application may be made by any interested Person in accordance with Ordinance Section 6(a)(13).

1.4.9 Public Meetings.

After expiration of the public comment period and upon the request of the Applicant or any other Affected Person, LCRA may hold a formal public meeting to consider the application in accordance with Ordinance Section 6(a)(14).

1.4.10 Master Plan/Phased Development Procedures.

When a Phased Development is proposed, the permit application shall be submitted and processed in accordance with Ordinance Section 6(b). Submittal requirements for the master plan are found in Appendix 1.6. Once the master plan is approved, a development permit is required for each phase per Section 1.4.3.

1.4.11 Variances

LCRA staff shall have the discretion to grant a variance to the provisions of this Ordinance on a case-by-case basis in accordance with Ordinance Section 10.

1.4.12 Appeals

An Applicant or an Affected Person may appeal a Development Permit decision by LCRA staff regarding the granting, denial, or revocation of a Development Permit under this Ordinance in accordance with Ordinance Section 11.

1.5 *Best Management Practice (BMP) Maintenance Permit*

1.5.1 Overview:

A BMP Maintenance Permit shall be issued to the developer or his assignee upon completion of construction of the infrastructure and permanent BMP facilities required by the Development Permit and receipt of the engineer's certification. In the event that the Landowner, maintenance or Property Owner's Association does not accept the assignment, the developer shall remain subject to the terms of the Development Permit or BMP Maintenance Permit, as applicable, until an assignment occurs or until the maintenance, Property Owner's Association, or Landowner obtains a BMP Maintenance permit. The responsible maintenance party shall demonstrate fiscal responsibility to perform maintenance requirements. Chapter 5 of this Manual contains Guidelines for permanent BMP Maintenance.

1.5.2 Procedures:

- a. Submit application and pay fee. Submittal requirements and the fee schedule are found in Appendix 1.7 and 1.3 respectively. The application should be made sufficiently in advance of the project completion to ensure timely release of financial security.
- b. LCRA will review the Application within 15 calendar days of receipt of a complete application.
- c. If additional information is required during the 15 calendar day technical review period, the applicant will be notified and given 30 calendar days to respond.

The permit holder is responsible for performing periodic inspections and maintenance according to the schedule included in the permit. The permit holder shall maintain records documenting inspection and maintenance activities, and make available to LCRA upon request. The permit holder shall notify LCRA of any ownership changes and provide documentation of fiscal responsibility to perform maintenance requirements. LCRA will perform periodic inspections of permanent BMP(s) and contact permit holders for corrective action as necessary. The inspection will focus on items identified in Appendix 1.7.2 for water quality basins and Appendix 1.7.3 for vegetative BMPs. These checklists can be used as a guide for BMP maintenance managers.

1.6 Utility General Permit

1.6.1 Overview:

The General Utility Permit covers routine utility construction and maintenance/repair work through an alternative process where the LCRA and a public utility agree on measures to comply with the Watershed Ordinance without requiring a permit for each separate project. If the utility development proposes Impervious Cover that is greater than 10,000 square feet, a Development Permit is required. A Utility shall submit a notice of intent prior to commencing construction on any utility project.

Activities which are authorized under a General Utility Permit include: Water and wastewater distribution facilities and associated appurtenances (manholes, valves, hydrants, pumps); liquid or gas distribution facilities and associated appurtenances; stormwater collection and distribution facilities and associated appurtenances; electrical distribution facilities; telecommunication lines and distribution facilities; and any other similar utility line or distribution facilities.

An application must be submitted and a Utility Permit issued prior to commencing construction on any utility projects. Construction under a Utility Permit requires notice by the permittee to LCRA. General Permit Activities are not required to comply with subsections (a), (b), (e), and (f) of Section 5 of the Ordinance. The applicant is required to comply with the erosion and sedimentation control requirements found in Chapter 2 and 3 of this manual.

1.6.2 Procedures:

- a. Submit application and pay fee. Submittal requirements and fee schedule are found in Appendix 1.8.
- b. LCRA will establish criteria and conditions for the Utility Permit for each utility on a case-by-case basis.
- c. The criteria established in the Utility Permit will detail when construction plans will be required to be submitted to LCRA.
- d. Projects covered by a Utility Permit are subject to routine inspections by LCRA inspectors to insure compliance with the general utility permit and/or construction plans.
- e. Utilities constructed by private developers as part of an overall project are required to include the utility construction in the Development permit for the site or obtain a separate permit if necessary.

1.7 Preliminary and Final Plat Review

1.7.1 Overview:

The LCRA, in conjunction with participating Cities, Villages and Counties, will review preliminary and final plats for subdivisions. LCRA may provide comments to the appropriate entity and the applicant regarding compliance with the LCRA Ordinances.

1.7.2 Procedures

- a. Submit plan and/or plat for review and pay fees.
- b. LCRA determines whether application is complete in accordance with the Submittal Requirements found in Appendix 1.9 and 1.10. If the submittal is incomplete, LCRA will request additional information. Once the additional information is submitted, LCRA will perform its review.
- c. LCRA provides comment and/or an approval letter to the appropriate entity and/or the applicant.

All of the items on the checklist may not be applicable to every application. Completion of the checklist will be considered on a case-by-case basis by LCRA.

Chapter 2 – Development Activity Meeting Water Quality Protection Performance Standards

2.1 Introduction

The LCRA’s Highland Lakes Watershed Ordinance requires the management of stormwater runoff from development activity through the implementation of best management practices (BMPs). The Ordinance includes Alternate Standards and stormwater credits to encourage low-impact development design. It is hoped that these design standards and environmental incentives will produce improved methods of stormwater management by relying less on individual BMPs and more on mimicking existing hydrology through total site design techniques. This approach can eliminate constructed water quality basins with limited impervious cover or produce smaller facilities that are less costly.

Development activities which must comply with these standards include the construction of buildings, roads, paved storage areas, and parking lots. Development also includes any land disturbing construction activities or human-made change of the land surface including clearing of vegetative cover, excavating, dredging and filling, grading, contouring, mining, and the deposit of refuse, waste or fill. Refer to Appendix 1.1 to review the Ordinance and its application to your project.

The Highland Lakes Watershed Ordinance contains five (5) performance standards for water quality management and are summarized in the Table 2-1.

**Table 2-1
Summary of Performance Standards**

Performance Standards	Ordinance Section	Minimum Requirements
Pre-development Planning	Section 5 (a)	Meeting with LCRA staff
Water Quality Management	Section 5 (b)	BMP design, determine compliance with Alt Standards
Buffer Zones	Section 5 (c)	Delineate buffer widths on creek per Ordinance criteria
Construction- Phase Erosion and Sediment Control	Section 5 (d)	Construction phase erosion control plan
Water Quality Education	Section 5 (e)	Contact LCRA to initiate education program

2.2 *Pre-Development Planning*

Pre-development planning is the important first step in all projects. Section 5(a) in the Highland Lakes Ordinance states:

A pre-development/concept plan meeting shall occur for all single-family development projects greater than 20 acres in area and all commercial development greater than three (3) acres in area. The meeting will focus on land plan, slopes, floodplains, buffer zones, water quality management practices, and may include a site reconnaissance. **For these types of projects, a development permit application can only be submitted after the completion of this task.**

A pre-development planning checklist (Appendix 2-5) is encouraged for use in evaluating the site for development. This checklist is used as a quick reference to aid in development planning, not a list of requirements for a development. Sound land use planning is perhaps the most important step in managing construction and post-development runoff problems. All new development plans (e.g., subdivisions, shopping centers, industrial parks, office centers, etc.) and redevelopment plans should be based upon accurate topographic data, up-to-date aerial photographs, field reconnaissance of the site, soils information, and knowledge of unique resources that serve as an amenity and add value to the project. Site planning can then proceed to minimize drainage impacts, avoid the concentration of flow to the maximum extent practical, and use the natural topography and vegetation to manage stormwater runoff. Comprehensive site planning can reduce impervious cover and stormwater runoff volume, potentially gaining compliance with Alternate Standards and avoiding the need for costly structural water quality basins. Additional pre-development planning details are found in Appendix 2-5.

Once a pre-development plan is prepared for the proposed development, the designer will need to coordinate with LCRA to convene a pre-development planning meeting. Upon completion of the pre-development meeting, LCRA will provide a letter to confirm that a meeting was held.

2.3 *Water Quality Management (BMP Design and Assessment)*

Water quality management is provided for the protection of water quality and drainage-ways from channel erosion. This chapter presents the methodology to calculate the design water quality volume and stormwater credit benefits. Each development not in compliance with Alternate Standards shall provide water quality volume in approved BMPs found in Chapter 4.

2.3.1 Alternate Standards

Development

Alternate BMP requirements employing low impervious cover levels with vegetative conveyance of stormwater runoff have been established. Compliance with the following

specifications is assumed to meet the water quality management performance standards found in 5 (b) of the Ordinance. Development eligible for these Alternative Standards must meet the following design requirements:

- a) The gross development site impervious cover is 15 percent or less and the cluster development sections (individual drainage areas) have 20 percent or less gross impervious cover,
- b) Street and drainage network is designed to include the use of open-roadway sections, ribbon curb, and maintenance of sheet flow,
- c) Stormwater credits as defined in this manual can be used to gain compliance with the impervious cover limits stated above.
- d) Commercial tracts with gross impervious cover less than 15% can obtain Alternate Standards compliance by providing vegetated filter strips per below and satisfying the above conditions.

A cluster development section can be considered as an individual drainage area or discharge point containing development. The impervious cover is computed within this area and divided by the drainage area to determine the cluster development impervious cover percentage.

Commercial Development

For commercial projects less than three (3) acres in area, Alternate BMP requirements using vegetated filter strips designed per Chapter 4 have been established. Compliance with the following specifications is assumed to meet the water quality management performance standards found in Section 5 (b) of the Ordinance. Commercial development eligible for these alternative standards must meet the following design requirements:

- a) Projects less than three (3) acres in area can achieve compliance with this section through the use of vegetated filter strips and flow spreading methodologies.
- b) The vegetated filter strip area is computed per the criteria found in this Chapter and designed and constructed per the guidance in Chapter 4.
- c) Vegetative filter strips must be located down-gradient of the developed areas.
- d) Runoff must discharge in a sheet flow manner from the impervious areas to the vegetated filter strips. See Chapters 3 and 4 for guidance.
- e) Stormwater Credits as defined in this manual can be used to gain compliance with this standard by reducing effective impervious cover to three (3) acres or less.

Projects gaining compliance with Alternate Standards still must perform pre-development planning (if required), delineate creek buffers, prepare an erosion and sediment control plan, and incorporate water quality education materials.

2.3.2 Stormwater Credits

The stormwater basin sizing criteria provides a strong incentive to reduce impervious cover at development sites, since significant reductions in impervious cover will result in smaller and less costly water quality basins. Impervious cover includes but is not limited to:

- Pavement including streets, driveways, parking lots, sidewalks, etc
- Rooftops
- Other surfaces that prevent the infiltration of water into the soil.

The techniques presented below are considered options for use by designers to gain compliance with the Alternate Standards or reduce water quality basin size. Due to local codes, soil conditions, and topography, some of these site design features may be restricted. In single-family subdivisions, stormwater credits will most likely be accrued on single-family lots. Since these activities will be constructed by homebuilders and not the developer, the stormwater credit will require easements, deed restrictions, or other articles approved by LCRA in the permitting process to ensure the proper installation, maintenance, and survivability. Designers are encouraged to consult with the LCRA to determine Stormwater Credit restrictions. Additional details for each credit can be found in Chapter 4.3.

Table 2-2 Stormwater Credits

Stormwater Credits	Alternate Standard Application	Water Quality Volume Application	Comments
Porous pavement (concrete) or paver blocks	Reduce paved area IC by 90% for porous pavement, reduction for pavers based on void space and reduction factor	Reduce paved area IC by 90% for porous pavement, reduction for pavers based on void space and reduction factor	Paving blocks receive reduced credit per design guidance
Rainwater harvesting (cisterns)	Reduce roof top IC up to 75%	Reduce roof top IC based on tank volume ratio to catchment area	Tank volume requirements related to catchment area
Soil amendment	Reduce IC by 2%	Reduce drainage area IC by 2% to water quality basin	6-8" blended soil depth and appropriate turf
Conservation landscaping	Reduce IC by 5%	Reduce drainage area IC by 5% to water quality basin	Limitations on turf area, use native plants/shrubs
Disconnection of roof-top runoff	Deduction of rooftop IC based on flow length and rainwater storage	Deduction of rooftop IC based on flow length and rainwater storage	75' flow length for full deduction with 90% grass
Natural area Preservation	Include natural area in development cluster impervious cover calculation	Natural area is subtracted from drainage basin area	Supports conservation development initiatives, yet connects to hydrology

IC = Impervious Cover

VFS = Vegetated Filter Strip

See below for calculation procedures for each stormwater credit

Porous Pavement refers to porous asphalt and porous concrete surfaces through which stormwater runoff can infiltrate to the soil profile. Reduced impervious cover credit is computed per Equation 2.1.

Equation 2.1 $A_r = A_p * 0.90$

Where: A_r = Allowable reduction in impervious cover
 A_p = Area of porous pavement

Pavers refer to discrete paver elements or similar surfaces which stormwater can infiltrate to the soil profile. Reduced impervious cover credit is computed per Equation 2.2.

Equation 2.2 $A_r = A_p * \%_0 * 0.75$

Where: A_r = Allowable reduction in impervious cover
 A_p = Area of porous pavement
 $\%_0$ = Percent open space of the paver system

See 4.3.1 for details and specifications.

Rainwater Harvesting refers to the collection of stormwater runoff from roof-tops and its use for domestic or landscape purposes. Reduced impervious cover credit is computed per Equation 2.3. See Figure 2-1 below.

Equation 2.3 $A_r = A_{RT} * \%_{IC \text{ REDUCTION FACTOR}} \text{ (Per Figure 2-1 below)}$

Where: A_r = Allowable reduction in impervious cover
 A_{RT} = Area of roof-top directed to rain barrel(s) (catchment area) (sq ft)
 $\%_{IC \text{ REDUCTION FACTOR}}$ = % Impervious area reduction
RBV = Rain barrel volume (cubic feet)

See 4.3.2 for details and specifications.

Rainwater Harvesting Effectiveness

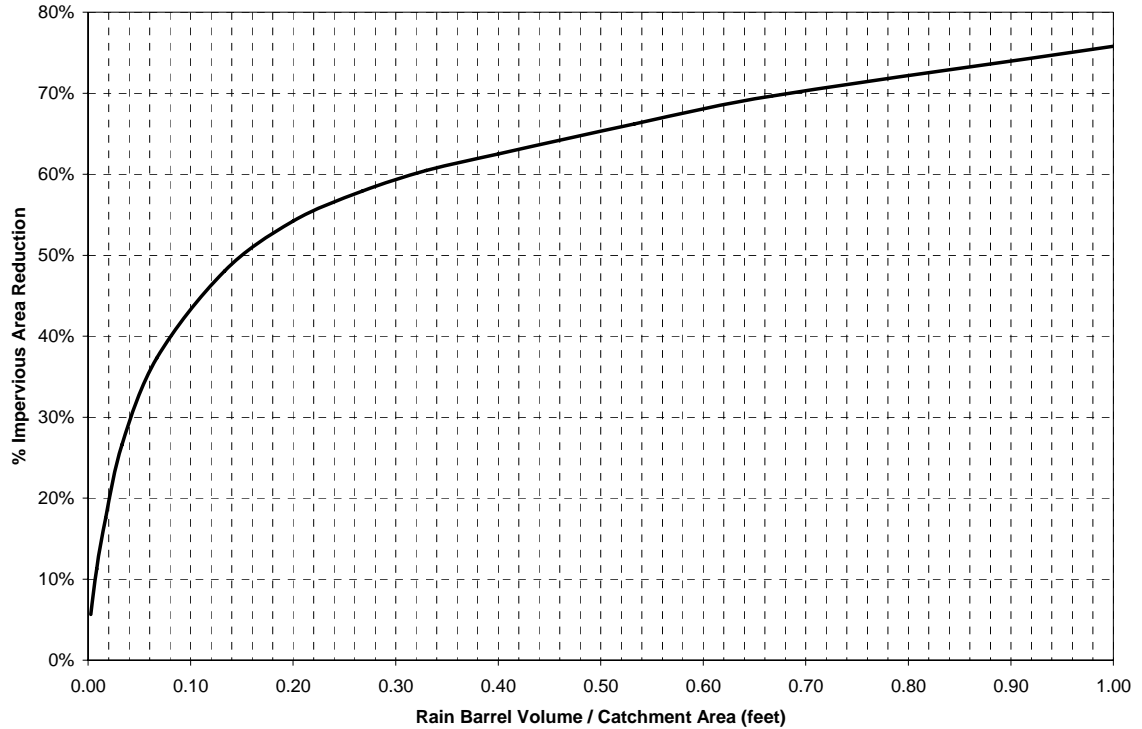

Figure 2-1 Rainwater Collection Credit

Soil Amendment refers to the placement of native or blended soils to a depth of six (6) to eight (8) inches to support appropriate turf grasses and landscaping. The soil amendment is applied to all lots within the development. Reduced impervious cover credit is computed by Equation 2.4.

Equation 2.4 $A_r = A_D * 0.02$

Where: A_r = Allowable reduction in impervious cover

A_D = Area of development

Conservation Landscaping refers to the use of limited turf area, preservation of natural vegetation, and the planting of native trees, shrubs, and perennials to infiltrate stormwater runoff and minimize chemical use. The conservation landscaping is applied to all lots within the development. Reduced impervious cover credit is computed by Equation 2.4.1.

Equation 2.4.1 $A_r = A_D * 0.05$

Where: A_r = Allowable reduction in impervious cover

A_D = Area of development

See Section 4.3.3 for details and specifications.

Roof-top Disconnection Credit. Using Table 2-3, the designer can deduct the disconnected impervious cover from the total impervious cover. The credit is based on distance of disconnection of roof top from conveyance system and/or use of localized water storage areas (rain gardens, bioretention, dry well, or cistern) in combination with the roof-top disconnection length. This credit applies only to single-family development with an average lawn slope of 5% or less.

Table 2-3 Rooftop Disconnection Impervious Cover Credit

Disconnection Length Provided	0 to 14 ft.	15 to 29 ft.	30 to 44 ft.	45 to 59 ft.	61 to 74 ft.	> 75 ft.
% Impervious Cover Credit Per Disconnection	0%	20%	40%	60%	80%	100%
Dry Well, Rainwater Harvesting, Rain Garden, Storage Volume Required to achieve 100% Credit (in combination with flow length)	104 cu-ft.	83 cu-ft.	62 cu-ft.	42 cu-ft.	21 cu-ft.	0 cu-ft.

Source: 2000 Maryland Stormwater Design Manual and LCRA.

Equation 2.5 $A_r = A_{RT} * \%_{ICD}$

Where: A_r = Allowable reduction in impervious cover

A_{RT} = Area of roof-top

$\%_{ICD}$ = Impervious cover credit factor per Table 2-3

The reduction in impervious cover per the above techniques is summed and then subtracted from the total impervious cover to determine the effective impervious cover.

Equation 2.6 $IC_{eff} = IC_{TOT} - (\text{Sum of individual } A_r)$

Where: IC_{eff} = Effective impervious cover

IC_{TOT} = Total impervious cover

The effective impervious cover is used to determine Alternate Standards compliance or compute the water quality volume in 2.3.3.

Natural Area Preservation Credit. The credit for stormwater basin volume is computed by subtracting the preserved area from the area draining to individual water quality basins. This credit is granted for all preservation areas permanently protected under conservation easements or other locally acceptable means. The credit is computed by Equation 2.7.

Equation 2.7 $DA_{\text{eff}} = DA_{\text{TOT}} - A_{\text{NA}}$

Where: DA_{eff} = Effective drainage area

A_{NA} = Natural area preserved

DA_{TOT} = Total drainage area

When computing water quality volume for a BMP using the natural area preservation credit, the designer will not need to adjust the effective impervious cover based on the reduced drainage area. See 4.3.5 for details.

Percent impervious cover is computed per Equation 2.8.

Equation 2.8 $IC = IC_{\text{eff}} / DA_{\text{TOT}}$

Where: IC = Percent impervious cover

2.3.3 Water Quality BMP Sizing

Water quality basins and the associated filter strips are sized to accomplish water quality protection and creek erosion management. The water quality basins will be sized to contain the runoff volume from the 1-year storm, which results in over 90% of the rainfall events being treated in an average year according to local rainfall records. The design includes the protection of creek channels since as much as 90% of sediment and other pollutants conveyed in urban waterways are caused by the increase in rate and volume of stormwater runoff from impervious cover associated with development. Thus, one design storm is used for both water quality and channel erosion management. The designer will use the 1-year developed peak discharge ($Q_{1\text{-year dev}}$) to size filter strips and level spreaders and use the 25-year developed peak discharge ($Q_{25\text{-year dev}}$) to size overflow weirs, flow splitters, and by-pass structures to provide conveyance and embankment safety at water quality basins. Refer to Appendix 2.4 for hydrologic and hydraulic information. **Designers are encouraged to use the design spreadsheet model to compute water quality basin size, filter strip size, and peak runoff rates. The model can be found in the front pocket of this manual or obtained by contacting LCRA.**

- 1) Compute the impervious cover for the development, use stormwater credits to reduce effective impervious cover, determine compliance with Alternate Standards.
- 2) Delineate drainage areas within development to define impervious cover percentage at each discharge point or BMP.
- 3) Select the appropriate BMP(s) to meet the site constraints and manage water quality and channel erosion.
- 4) Compute the water quality volume based on the runoff from the 1-year storm.
- 5) If necessary, compute the size of the secondary BMP(s).
- 6) Design the water quality BMPs per the guidance in Chapter 4 including discharge to the buffer zone in a sheet flow manner.

Step 1: Compute Impervious Cover

The one-year runoff volume is based upon the amount of impervious cover in the design drainage basin. The designer should consider the use of stormwater credits to reduce the effective impervious cover to gain compliance with Alternate Standards or reduce the design water quality volume.

When the development project includes residential tracts that will be developed subsequently, and whose future impervious level is unknown, the assumptions presented in Table 2-4 should be used. The values in this table do not include the area of the streets in the development.

Table 2-4 Impervious Cover Assumptions for Residential Tracts

Lot Size	Assumed Impervious Cover (ft²)
> 3 acres	10,000
Between 1 and 3 acres	7,000
Between 15,001 ft ² and 1 acre	5,000
Between 10,001 and 15,000 ft ²	3,500
Between 5,750 and 10,000 ft ²	2,500
< 5,750 ft ²	2,000

Step 2: Determine Drainage Area to BMP

The designer will determine the drainage area to the BMPs by utilizing topographic maps, site grading plans, and conveyance system maps. If offsite drainage contributes runoff to a BMP that is on-line, then the offsite area is included in the calculations to determine water quality volume. The designer may choose to divert offsite flow around the proposed development site or use a flow splitter device to create an off-line basin. If a flow splitter device is used, the BMP does not need to be sized for the off-site area once the designer demonstrates that the runoff from the development will arrive at the water quality basin before the off-site drainage area contributes runoff. However, the flow splitter and conveyance systems must be designed to safely convey runoff from the entire drainage area through the proposed hydraulic structures or channels. Off-line indicates

that a flow splitter device is used to divert runoff volume in excess of the design storm around the BMP. When the basin is full, the flow splitter device will isolate site runoff and minimize mixing from the off-site area.

When a site contains multiple drainage areas, the impervious cover shall be calculated for each area to determine the necessary water quality volume or compliance with Alternate Standards in each watershed.

Step 3: Select an Appropriate BMP

Permanent BMPs for managing stormwater runoff are listed in Table 2-5. This table highlights the potential advantages and challenges with each BMP type. Additional data and design guidance are found in Chapter 4.

Table 2-5 Permanent BMP Summary

Permanent BMPs	Requires Additional BMPs	Construction Cost	On-line/ Off line Location	Recommended Drainage Area Size (acres)	Maintenance Requirement	Liability/ Safety Issues
Vegetated Filter Strip	Possibly	Low	On-line	< 3 acres	Low	None
Extended Detention Pond	Yes	Moderate	On-line or off-line	less than 128 acres	Low to Medium	Low, short term standing water
Bioretention	No	Moderate	On-line or off-line	< 10 acres	Medium to High	Low, shallow standing water depth
Infiltration	Yes	Moderate	Off-line, downstream of primary BMP	Downstream of BMP	Medium to High	Moderate, standing water
Sand Filters	Yes	Moderate to High	Off-line	< 20 acres	Medium to High	Low, short term standing water
Wet Basins	Yes	Moderate to High	On-line or off-line	> 20 acres and less than 128	Medium to High	High, long term standing water
Constructed Wetlands	Yes	Moderate to High	On-line or off-line	> 20 acres and less than 128	Medium to High	Moderate, long-term Standing water
Retention Irrigation	No	High	On-line or off-line	Less than 128	Very High	High, short term standing water
Wet Vaults	Yes	Moderate to High	On-line	Manufacturer's specs	High	High, long term standing water, confined space
Stormwater Credits						
Porous Pavement	Possibly	Moderate	On-line	No off-site area drains to pavement	Moderate	Low, potential pavement issues
Rainwater Harvesting	Possibly	Moderate	On-line	House roof – top	Moderate	Low, rainwater stored in property owner tanks
Soil amendment and conservation landscaping	Possibly	Moderate	On-line	Lot size	Low	None
Roof-top Disconnection	Possibly	Low	On-line	House roof – top	Low	None
Natural Area Preservation	Possibly	Low	On-line	NA	Low	None

Research has shown that pollutant concentrations vary greatly from storm to storm, site to site, even within the same BMP type. Table 2-6 lists the pollutant removal performance of the approved BMPs. Redundancy built into a stormwater management system includes BMPs in series that reduce the potential for BMP failure and improve water quality runoff. While a pollutant such as dissolved phosphorus may be released from a sand filter basin, when discharged to a properly designed vegetative filter strip, the pollutant can be managed via infiltration, filtering, and plant up-take. When development design dictates the use of water quality basins, this manual recommends the selection of the low maintenance BMPs in combination with filter strips and/or infiltration to achieve the pollutant removal requirements. This approach minimizes the BMP cost and maintenance requirements, yet capitalizes on the planned landscapes, natural terrain, and soils to meet the pollutant removal goals.

Table 2- 6 BMP Pollution Management Performance

Permanent BMP	TSS Efficiency	TP Efficiency
Vegetated Strip	85%	70%
Sand Filter	80%	55%
Bioretention	80%	72%
Infiltration Trench/Basin	90%	90%
Retention/Irrigation	90%	90%
Extended Detention	68%	45%
Wet Pond/Wetland Basin	83%	65%

Source: James Miertschin and Associates, 2005.

Table based on treating 90% of the annual pollutant load.

BMP suites are BMP combinations that have been designed to meet the pollutant removal goals of the Highland Lakes Watershed Ordinance. The acceptable BMP suites are shown in Table 2-7. Most of these suites consist of two BMPs in series. The “primary” BMP or water quality basin will be designed to detain the erosion control volume and provide primary treatment of stormwater quality. The “secondary” BMP will be sized to accomplish additional pollutant removal to meet the Ordinance goals. As shown in Table 2-7, the vegetative secondary BMPs can be placed either upstream of (before) or downstream of (after) the primary BMP.

Table 2-7 Permanent BMP Suite Summary

BMP Suite	Primary BMP	Order	Secondary BMP
1	Sand Filter	Before	Infiltration Trench/Basin/Bioretention
2	Sand Filter	before or after	Vegetated Filter Strips
3	ED Pond	Before	Infiltration Trench/Basin/Bioretention
4	ED Pond	before or after	Vegetated Filter Strips
5	Wet Pond/Wetland	Before	Infiltration Trench/Basin/Bioretention
6	Wet Pond/Wetland	before or after	Bioretention
7	Wet Pond/Wetland	before or after	Vegetated Filter Strips
8	Vegetated Filter Strips		None in Commercial Alt Standards
9	Bioretention		None required
10	Retention/Irrigation		None required
11	Wet Pond w/ infiltration bench		None required
Note: 1. Vegetated Strips includes NVS, VFS, and VIS			
2. Infiltration trenches and basins may only be used in areas that meet minimum soil requirements.			
3. Vegetated Strips do not achieve streambank erosion protection on their own			

Source: James Miertschin and Associates, Inc., 2007

Only bioretention, retention/irrigation, and a wet pond/wetland basin with an infiltration bench can operate as stand-alone permanent BMPs. The remaining BMPs must operate in series with vegetated filter strips or infiltration. While it may appear more costly to include a secondary BMP, in practice, an extended detention pond combined with a downstream infiltration trench and vegetated filter strip will most likely cost less and require considerably less maintenance than a bioretention basin or a retention/irrigation system.

BMP selection may require several iterations to choose the appropriate water quality treatment system for the development project. The design spreadsheet tool promotes rapid BMP option evaluation. If the selected primary BMP requires a secondary BMP, then the designer will use the equations in Table 2-9 to determine the secondary BMP size.

Step 4: Compute Water Quality Volume

Table 2- 8
Runoff Volume
1-Year Storm Rainfall = 1.93 inches

Impervious Cover Percentage	Runoff Volume (in.)
15%	0.34
20%	0.42
30%	0.59
40%	0.75
50%	0.92
60%	1.08
70%	1.24
80%	1.41
90%	1.57
100%	1.74

Equation 2.9 Runoff Volume (inches) = [0.05 + (0.0085 * IC_{eff})] * 1.93

Where: IC_{eff} = Effective impervious cover percentage (percent)

Equation 2.10 Water Quality Volume (cubic feet) = DA * (Runoff Volume) * (43,560/12)

Where: *Runoff volume* = Volume of runoff from 1-year storm area based on impervious cover as shown in Table 2-8 and computed per Equation 2.9.

Water Quality Volume (WQV) = Required water quality capture volume (cubic feet) based on runoff volume from the contributing drainage area and computed per Equation 2.10.

DA = contributing drainage area (acres)

The water quality volume (WQV) is used to size the permanent BMP(s), both water quality basins and secondary BMPs (vegetated filter strips and infiltration devices). Table 2-9 is used to compute the size of the secondary BMP(s).

The designer must keep in mind that while the basin is sized for the 1-year storm, the design must also incorporate embankment safety, freeboard, and non-erosive conveyance for the 25-year storm as detailed in Chapter 4.

Step 5: Compute Secondary BMP Size (if necessary)

Use Table 2-9 to determine the area and/or volume of the secondary BMP for each primary BMP. Designers must take note that up-gradient vegetated filter strips (VFS) are also required to treat a percent area of the contributing drainage area to the water quality basin. The percent area treatment requirements are identified in Table 2-9. For filter strips up-gradient of the detention BMP (primary BMP), the filter strips must treat 90% of the area for extended detention basins, 70% of the area for sand filters, and 50% of the area for wet ponds. The up-gradient filter strips must be located in conservation easements and common areas to prevent structures from encroaching into the management areas to ensure long-term water quality treatment. In addition, these filter strips must be located down-gradient of the site improvements on each lot. Another option for up-gradient treatment is the application of conservation landscaping throughout the entire development per the guidance in Chapter 4.3.3 and evaluated on a case by case basis by LCRA to ensure appropriate location of natural areas and native plants down-gradient of developed areas. When using conservation landscaping as an up-gradient BMP, the stormwater credit of a 5% impervious cover reduction is not available.

Example water quality design calculations can be found in the Appendix. See:

Appendix 2.1 for Alternate Development Standards - Single family development

Appendix 2.1.1 Alternate Development Standards - Using stormwater credits to gain compliance including conservation landscaping, lot size = 1/5th of an acre

Appendix 2.1.2 Alternate Development Standards - Using stormwater credits to gain compliance including conservation landscaping, lot size = 1/2 of an acre

Appendix 2.2 for BMP Design - Single family development

Appendix 2.3 for BMP Design - Large commercial development

Table 2-9 Secondary BMP Sizing Guidance

Structural BMP	Vegetated Strip and Infiltration BMP Alternatives									
	Upgradient of Detention BMP			Downgradient of Detention BMP			Downgradient Bioretention Basin Volume (cf)	Downgradient Infiltration Basin Volume (cf)	Downgradient Infiltration Trench (void) Volume (cf)	Downgradient Trench+Strip* Combo Length (ft)
	NVS Area (sqft)	VFS Area (sqft)	VIS Area (sqft)	NVS Area (sqft)	VFS Area (sqft)	VIS Area (sqft)				
ED Pond	1.05*WQV	0.53*WQV	0.35*WQV	0.4*WQV	0.2*WQV	0.13*WQV	0.044*WQV	0.058*WQV	0.03*WQV	0.006*WQV
Sand Filter	0.77*WQV	0.39*WQV	0.26*WQV	0.3*WQV	0.15*WQV	0.1*WQV	0.033*WQV	0.044*WQV	0.023*WQV	0.0045*WQV
Wet Pond	0.69*WQV	0.35*WQV	0.23*WQV	0.26*WQV	0.13*WQV	0.09*WQV	0.029*WQV	0.042*WQV	0.023*WQV	0.0043*WQV

*For trench+strip combination, the cross sectional area of trench must be at least 8 sqft, and width of strip must be 15 ft if VFS, 30 ft if NVS

WQV = water quality volume in cubic feet (cf) based on runoff from the 1.93 inch storm and Equations 2-9 and 2-10.

NVS = natural vegetated filter strip (see 4.2.7(A) for details)

VFS = vegetated engineered filter strip (see 4.2.7(B) for details)

VIS = vegetated engineered infiltration strip (see 4.2.7(C) for details)

Table 2-10 Design Guidance for Soil Permeability

Soil Investigation Average k (in/hr)	Infiltration Basin Maximum Ponding Depth (ft)	VR% Infiltration Trench Volume Reduction %
Less than 0.30	Not Permitted	Not Permitted
0.30 to 0.49	0.8	0%
0.50 to 0.69	1.2	24%
0.70 to 0.89	1.6	39%
0.90 to 1.09	2	49%
1.10 to 1.29	2	56%
1.30 to 1.49	2	62%
Greater than 1.5	2	65%

Soils

In addition to slope, soil type and depth can be important factors for BMP selection. Soils in the Ordinance area are typically shallow and stony, with the majority exhibiting a depth of less than two feet, with permeabilities ranging from 0.2 to 2 inches an hour. Table 2-10 lists the design criteria for BMP permeability. The limited depth to bedrock and low soil permeability in some of the Highland Lakes watersheds may constrain the use of infiltration techniques and may require extensive excavation in rock for basins.

Table 2-11 shows the characteristics of the major soil associations in the Highland Lakes area.

TABLE 2-11

General Characteristics of Soils in the Highland Lakes Watersheds

Soil Type	Texture	Thickness (in)	Permeability (k) (in/hr)	CEC (meq/100g)
Brackett	Gravelly loam Sandy loam	0 – 48	0.20 - 0.63	2 - 17 (est.)
Tarrant	Stony clay loam	0 – 12	0.20 - 0.63	4 - 57 (est.)
Volente	Clay loam Silty Clay	0 – 54	0.20 - 2.00	4 - 57 (est.)
Pedernales	Sandy loam Sandy clay loam	0 – 72	0.20 - 2.00	2 - 57 (est.)

From: Woodruff, 1973

For more detailed information, the designer is referred to the following sources:

General soil properties: United States Dept. of Agriculture, Soil Surveys of Travis, Burnet, and Llano Counties, Texas.

Cation exchange capacity (CEC): Brady, Nyle C. *The Nature and Properties of Soils* - 8th Edition. Macmillan Publishing Co., 1974.

The above permeability requirements do not apply to flow spreading devices, since the primary purpose of the spreading device is to convert point discharges to sheet flow. In summary, infiltration trenches can be used as a flow spreader, even when permeability is less than 0.3 in/hour.

Step 6: Convert BMP Discharge and Bypass Flow to Sheet Flow Discharge to the Buffer Zone

Slope, channel, and bank erosion can occur where concentrated stormwater runoff is discharged from a water quality basin or storm drain system. At these locations, appropriate energy dissipation through flow spreading such as on-contour level spreaders, infiltration trenches, and vegetated filter strips must be incorporated in the design. See Chapters 3 and 4 for flow spreading design options and guidance. The designer will select one of the options to convert concentrated runoff to sheet flow. If not using a secondary BMP as a flow spreader, the flow spreader length (L) (perpendicular to flow) is computed as follows:

Equation 2.11 **Flow Spreader L (feet) = 5*Q_{1-year dev} (cfs)**

Water quality basins will discharge in a sheet flow manner to the buffer zone. This includes the discharge from the basin and the 25-year storm that is by-passed around or through the basin. There are two options:

- 1) The designer can locate the secondary BMP down-gradient of the water quality basin (primary BMP) and size the vegetated filter strip, infiltration trench, or infiltration basin per requirements in Table 2-9. The secondary BMP in this location will serve as the flow spreading device.
- 2) When the secondary BMPs are located upstream of the water quality basin or the BMP is a stand alone system, the flow spreading device length shall be determined by Equation 2.11. The designer can use the infiltration trench, vegetated filter strip with flow spreader, or on-contour level spreader.

Commercial Alternate Standards

Vegetated Filter Strip Sizing Requirements

To achieve alternate standard compliance for commercial projects less than 3 acres in area, the designer shall use one of the following filter strip types and respective equations to determine the appropriate filter strip area. All filter strips must receive runoff in a sheet flow manner from impervious area sources. No collection or routing of runoff from the impervious surface to the filter strip is allowed, unless the runoff is discharged on the contour and flow is spread through the use of a level spreader as shown in Chapter 3. See Chapter 4 for design guidance and construction requirements.

Natural Vegetate Filter Strip (NVS)

Equation 2-12 **NVS (square feet) = Water Quality Volume*2.27**

Vegetated Filter Strip (VFS)

Equation 2-13 **VFS (square feet) = Water Quality Volume*1.15**

Vegetated Infiltration Strip (VIS)

Equation 2-14 **VIS (square feet) = Water Quality Volume*0.77**

To ensure sheet flow and minimize erosion of the filter strip, the minimum filter strip length (perpendicular to flow) is computed per Equation 2-15. See Chapter 4 for additional information.

Equation 2-15 **Filter Strip L (feet) = 10*Q_{1-year dev} (cfs)**

2.4 Buffer Zones

Section 5(c) of the Highland Lakes Watershed Ordinance identifies the buffer zone requirements. Buffer zones protect waterways and aquatic resources from the short and long term impacts of development activities. Buffer zones shall remain free of construction, development, or other alterations except for utility and roadway crossings. The number of crossings through buffer zones should be minimized. No stormwater treatment facilities, golf courses, or wastewater irrigation shall be located in the Buffer Zone. Stormwater discharge from the development shall be dispersed into overland patterns before reaching the buffer zone.

Buffer zones are located on creeks or swales that have more than five (5) acres of contributing drainage area. To protect the creek buffer, stormwater discharged from water quality basins must enter the buffer in a sheet flow manner. By-pass flows from storms in excess of the basin design storm must be conveyed in a stable manner through the buffer zone to the receiving water body. This can be accomplished through application of the level spreader systems presented in Chapter 4. Some limited vegetation management is allowed within the buffer zone to enhance the character of the buffer, however, this effort must be approved by LCRA before commencement. Additional information relating to the buffer zones can be found in Appendix 2.6.

As defined in the Highland Lakes Watershed Ordinance, a creek is a well-defined channel that can convey running water. This definition will be used to determine the beginning or upper-most headwater of the creek to initiate the application of the buffer zones.

- (1) **Buffer Zones in Burnet and Llano Counties Requirements:** A buffer zone shall be established at a width of 25 feet from the top of the channel bank on both sides of the creek. The area between the top of banks (creek) is also considered part of the buffer zone. This applies to creeks or swales draining more than five acres of area, excluding roadside swales.

(2) **Buffer Zones in Travis County – Two Options:**

(i) **Option 1: Buffer Zones**

(a) Creeks or swales draining less than 40 acres but more than five (5) acres, excluding roadside swales, shall have a minimum buffer width of 25 feet from the centerline of the Creek or swale.

(b) Creeks or swales draining less than 128 acres but more than 40 acres shall have a minimum buffer width of 75 feet from the centerline of the creek or swale.

(c) Creeks draining less than 320 acres but more than 128 acres shall have a minimum buffer width of 100 feet from the centerline of the creek or swale.

(d) Creeks draining less than 640 acres but more than 320 acres shall have a minimum buffer width of 200 feet from the centerline of the creek or swale.

(e) Creeks draining 640 acres or greater shall have a minimum buffer width of 300 feet from the centerline of the creek or swale.

(ii) **Option 2: Floodplain Buffer Zone.** For creeks or rivers draining less than 40 square miles but more than five (5) acres, the buffer zone shall extend a minimum of 25 feet from the 100-year floodplain boundary paralleling each side of the creek or swale. The 100-year floodplain shall be based on the fully developed conditions as approved by LCRA.

For creeks or rivers draining more than 40 square miles, the Buffer zone shall be considered equal to the 100-year floodplain as designated by Federal Emergency Management Agency or by an engineered floodplain study approved by LCRA.

BUFFER ZONES

BURNET & LLANO COUNTIES

**BUFFER ZONES EXTEND 25 FEET
FROM THE TOP OF CHANNEL BANK**

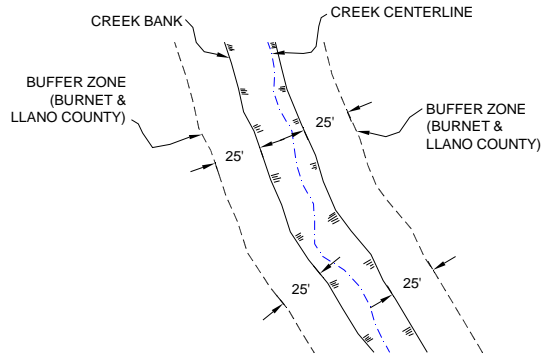

TRAVIS COUNTY

**OPTION NO.1
BUFFER SETBACKS
BASED ON DRAINAGE AREA**

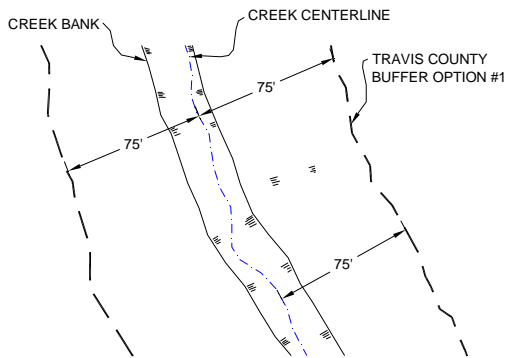

<u>DRAINAGE AREA</u>	<u>BUFFER WIDTH FROM CREEK CENTERLINE</u>
5 < DRAINAGE AREA < 40 ACRES	25 FT
*40 < DRAINAGE AREA < 128 ACRES	75 FT
128 < DRAINAGE AREA < 320 ACRES	100 FT
320 < DRAINAGE AREA < 640 ACRES	200 FT
640 < DRAINAGE AREA	300 FT

*ILLUSTRATED ABOVE

**OPTION NO.2
BUFFER SETBACK
BASED ON FLOODPLAIN**

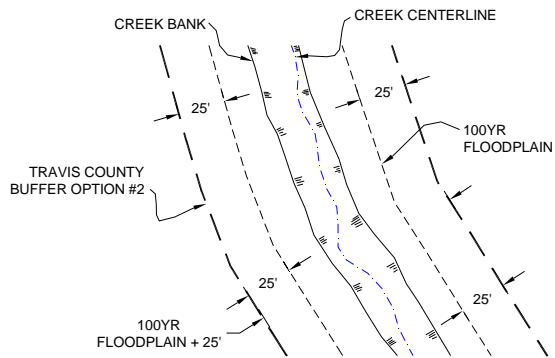

<u>DRAINAGE AREA</u>	<u>BUFFER WIDTH FROM CREEK CENTERLINE</u>
5 ACRES < DRAINAGE AREA < 40 SQ. MILES	100YR FLOODPLAIN + 25 FT
40 SQ. MILES < DRAINAGE AREA	100YR FLOODPLAIN

Figure 2.2: Buffer Zone Schematic

2.4.1 Buffer Zone Technical Requirements

- Delineation of the buffer zone on all plan sets, including clearing, grading, and construction plans.
- Installation physical barriers (e.g., fencing or other barriers) along the buffer zone boundary *prior* to any clearing, grading, or construction activities.

It is recognized that there are some necessary impacts to the buffer. The following disturbances may be allowed in the buffer zone, the following criteria should minimize these impacts.

- *Roadway Crossings:* Road crossings of creeks should be minimized. Grading, including cut and fill, should be reduced to a minimum. Open sections and swales should be used and concentration of flows into large pipes or outlet structures should be minimized. Where possible, sheet flow will be directed to buffer zones in order to take advantage of the pollutant filtering potential of the buffer. The roadway design should consider long-term channel and bank stability and habitat and use appropriate techniques to manage anticipated long-term channel adjustments. Vegetation and/or soil protection blankets are to be installed immediately after embankment compaction to prevent soil discharges. Roadway crossings can be optimized to serve as stormwater detention structures when culverts are sized to manage peak flow rates and the flood storage pool remains undisturbed. Limited clearing of vegetation via hand methods may be allowed and requires approval before activity commencement.
- *Stormwater Detention Structures:* Stormwater detention is allowed within the buffer zone when the detention embankment/structure occupies a narrow foot print similar to utility and roadway crossings and no excavation takes place within the flood storage pool. Limited clearing of vegetation via hand methods may be allowed and requires approval before activity commencement. Rock or concrete wall structures can serve as the embankment within a small disturbance area and are recommended. Each proposal will be reviewed on a case by case basis to minimize buffer zone disturbance to the maximum extent possible.
- *Utility Crossings:* Grade controls and bank stabilization should be placed at all crossings of drainage ways. For those utilities that do not require continual access, replacement and revegetation with in-kind native plants is recommended. Utility crossings should occur at or near right angles to the maximum extent practical. The utility design should consider long-term channel and bank stability and use appropriate techniques to manage anticipated long-term channel adjustments. See Chapter 3 for details.
- *Low impact park development:* Development within the buffer zone should be limited to trails, picnic facilities, and similar construction that do not significantly alter the existing vegetation or drainage patterns. Trail width should be minimized and the use of gravel, mulch, or other alternate paving surfaces should be considered if all accessibility and emergency vehicle needs are met. Trails should be graded so that they do not concentrate flows and adequate outfall protection should be provided at crossings of minor drainage ways. Trails should include areas for pet waste management and adequate signage to encourage cleanup of any pet wastes. Pedestrian bridges should be considered at major crossings, rather than culverts.

- *Storm Drainage Outfalls:* Direct connection of shallow concentrated flow, open channel flow and storm drain pipes to the stream channel through the buffer shall be avoided. Energy dissipation devices, such as on-contour level spreaders, infiltration trenches, vegetated filter strips, rock trenches, inverted weirs or other permanent BMPs shall be placed outside of the buffer to produce sheet flow. After the stormwater energy is diffused before entering the buffer, the resultant runoff should enter the receiving channel at non-erosive velocities as shallow concentrated flow.

Rock riprap of sufficient size should be placed downstream of the storm drain outfalls to manage scour and protect the outfall structure. Designers should refer to Chapter 3 to determine rock size and apron length.

- *Level Spreaders:* A level spreader typically is an outlet designed to convert concentrated runoff to sheet flow and disperse/dissipate its energy uniformly across a slope to prevent erosion. Level spreader systems are presented in Chapter 3 and 4.

2.5 Construction - Phase Erosion and Sediment Control Planning

Section 5 (d) of the Highland Lakes Watershed Ordinance requires the use of erosion controls through the development process. The development of and adherence to a TCEQ Stormwater Pollution Prevention Plan (SWPPP) shall be considered to meet the requirement for erosion and sediment control. The permittee shall make the SWPPP inspection records and reports available to LCRA upon request. To minimize sediment transport, site disturbance must be phased to limit soil erosion and final stabilization shall be accomplished with each phase. Prior to construction commencement, LCRA will provide training materials to the contractor including preservation of existing vegetation, construction phasing, installation and maintenance of temporary erosion and sediment controls, re-seeding, and buffer zone protection. LCRA will meet with the contractor and review the training materials and inspect the temporary erosion controls at the time construction begins.

The most effective erosion control is the minimization of disturbed area. When this practice is combined with rapid re-vegetation of disturbed areas, the receiving water bodies can be protected from sedimentation. Final stabilization of soil disturbing activities are considered complete when perennial vegetative cover reaches 70% density of the native background vegetative cover for the area. Permanent BMPs must achieve a density of 80% vegetative cover to be considered complete.

This section outlines the necessary steps for creating an effective erosion and sediment control plan. Details for individual erosion and sediment control BMPs can be found in Chapter 3.

- a. Assess the drainage characteristics and construction phasing of a site. This process should identify:
 - Patterns of stormwater flowing over the site including off-site sources, sub-drainage areas, sheet-flow areas, concentrated flow areas and exit points.
 - Location of proposed cuts and fills, grading, curbing, buildings, and impacts on drainage/sequence of construction relating to initial, interim and final drainage.
 - Necessary access points.
 - Limits of construction and non-disturbance area.
 - Construction equipment storage areas.
- b. Determine the location of the temporary erosion controls including:
 - Locate controls as close to disturbed areas as possible allowing room for construction activities and maintenance of controls.
 - Assure there are no breaks or points where runoff can bypass or short-circuit the temporary erosion controls.
 - Locate controls so as not to create off-site flooding of adjacent properties.
- c. Based on steps A and B, the category or function of controls and their phasing should be determined to reflect the construction sequence and changing drainage patterns.
- d. Finally, the designer must determine specific controls to be shown at the locations chosen in step C.
- e. Perform an adequacy check to determine compliance with the following items:
 - Controls used are within the allowable drainage area limits.
 - Controls are located perpendicular to the runoff flow.
 - Detention controls are shaped to create adequate areas for ponding and sediment accumulation.
 - Install detention/filtration controls along contours to promote spreading of runoff.
 - Locate controls in low traffic areas that are easily accessible for maintenance.
 - Controls should be phased as necessary to reflect changes in drainage patterns to remain effective throughout the construction period.
 - Locate controls in areas that will not cause flooding of adjacent properties.

Additional guidance on construction sediment management can be found in Appendix 2.7. Erosion and sediment challenges will vary significantly from site to site. In order to recognize sites that have more erosion potential than others, the designer will rank the erosion potential based on the site characteristics in Table 2-12.

Erosion Potential - Ranking Categories

High Erosion Potential – Key factors that impact erosion potential are steep slopes, soils conducive to erosion, construction disturbance covers a large area and extend over a significant duration, and roadways are planned to cross creeks.

Low Erosion Potential – Minimal disturbance area, short construction period, relatively flat slopes, and non-erosion prone soils are common traits of sites that have a low potential for erosion problems.

Table 2-12 Site Characteristics for High Erosion Potential Checklist

- _____ Disturbed area > Five (5) acres
- _____ More than 25% of development area has slopes > 10 %
- _____ Soils – silts/clays from SCS Soil Surveys
- _____ Existing vegetative cover < 50 % coverage (groundcover)
- _____ Off-site drainage area > Five (5) acres (discharges to site)
- _____ Construction duration > Six (6) months
- _____ Utility and road crossing(s) of drainage ways/buffer zones
- _____ Distance of soil disturbance from creek centerline is less than 100 feet

If a development project is within different drainage areas or has more than one discharge point, then the above rating is applied to each drainage area/discharge point.

**A project has a High Erosion Potential IF:
Four or more items are checked in Table 2-12**

The designer can use Table 2-12 to determine if a project has high erosion potential. Sites that rank as having a high potential for erosion will require special attention in the design, implementation, and maintenance of construction activities and temporary erosion and sediment controls. This form is found in Appendix 2-8.

To aid in the proper selection of erosion control and stabilization techniques, Table 2-13 presents typical erosion site characteristics and the accompanying BMPs.

**Table 2-13 Erosion Control Selection Guidance
Suggested Techniques to Minimize Soil Erosion**

Site Characteristics	Management Approach	BMP Tools	Comments
Disturbed Area > 5 acres	Limit disturbance, control access to non-construction areas and buffers	Temporary Fencing	Identify disturbed and protected areas on the construction plans
Slopes > 10%	Limit construction on steep slopes, stabilize immediately	Silt Fencing Rock berms Compost/mulch/seed	Seed and vegetate as soon as possible, use soil protection blankets or compost-seed mixes.
Soils – clay/silt	Minimize excavation, cover/vegetate immediately	Silt Fence Blankets & Matting Compost/mulch/seed Sod/seed	Difficult to settle soil particles, minimize disturbed area
Vegetative Cover < 50%	Minimize disturbance in this area, enhance vegetation	Seed Sod Compost/mulch/seed	Promote rapid vegetation growth
Off-site Drainage Area > 5 acres	By-pass runoff around site, or convey in stable manner	Diversion Dikes Interceptor Swales Pipe/slope Drain	Maintain diversion BMPs during construction to prevent sedimentation of devices
Construction Duration > 6 months	Phase construction disturbance, stabilize disturbed areas	Vegetation Blankets & Matting	Develop construction disturbance and re-vegetation plan as part of construction sequence
Road Crossings of Drainage ways	Minimize crossings, stabilize road cuts as soon as possible	Temporary Sediment Basins	Basin size – 1,800 cubic feet per disturbed acre drainage to basin
Distance < 100 feet from drainage	Relocate disturbed areas beyond the buffer zone limits	Silt Fence Rock Berms Sediment Basins	Identify creek buffer zones, perform work and maintain stockpiles outside of this zone

2.6 *Water Quality Education*

Section 5(e) of the Highland Lakes Watershed Ordinance requires a recipient of a development permit to participate in a water quality education program using LCRA and/or other LCRA approved water quality education materials that focus on water quality protection. **The development project manager shall contact LCRA as the permitted project nears construction completion to initiate the education process.**

Water quality education will include the following components to promote limited chemical use, proper storage of chemicals, appropriate landscapes, and good housekeeping practices to minimize watershed residents' impact to the receiving water-body. Activities include:

- Homeowner education programs on at least an annual basis, which can be provided by LCRA and/or include the distribution of LCRA or LCRA approved education materials,
- Education materials are provided to new residents at the time of occupying their home or establishment,
- Education events sponsored by LCRA and other agencies to promote creek cleanups, roadside trash collection days, and adoption of creeks and highways.
- Household hazardous waste collection events.

Additional information can be found in Appendix 2.9 and 2.10.4.

Chapter 3

Erosion and Sediment Control Best Management Practices

3.1 *Introduction*

This chapter gives instructions for installation of the most commonly used erosion and sediment control practices. Each practice is presented with a list of guidelines for proper installation and a compilation of common trouble points. Additional information on these and other practices can be found in other manuals.

Contractors are encouraged to install and maintain practices carefully, in a professional manner. Minor adjustments should be anticipated to assure proper performance. Intensive maintenance and extensive use of vegetation, mulch, and other ground covers may be required to achieve optimum performance. We recommend very strongly, therefore, that such erosion and sediment control efforts be specified clearly in the general construction contract and that any unexpected expenses be approved before they are incurred. When these controls are removed after final stabilization of the site, it is important to also remove or stabilize any accumulated sediment.

Periodic inspection and maintenance is vital to the performance of erosion and sedimentation control measures. It is recommended that all temporary erosion controls be inspected weekly and after every rainfall; however, daily inspections may be warranted when environmentally sensitive features are located on or immediately adjacent to the site. If not properly maintained, some practices may cause more damage than they prevent.

This manual includes guidance for minimum design criteria for sizing BMPs in Chapter 2. Tables are provided in Appendix 2.4 for the calculation of stormwater runoff and conveyance capacity. Always evaluate the consequences of a measure failing when considering which control measure to use, since failure of a practice may be hazardous or damaging to both people and property. For example, a large sediment basin failure can have disastrous results; low points in dikes can cause major gullies to form on a fill slope. It is essential to inspect all practices to determine that they are working properly and to ensure that problems are corrected as soon as they develop. Assign an individual responsibility for routine checks of operating erosion and sedimentation control practices.

3.2 *Erosion Control BMPs*

Temporary Erosion Controls should be considered the first line of defense for prevention of water pollution during construction activities. It is much simpler to maintain the soil cover than to trap the sediment once it has been mobilized. In addition effective erosion prevention can result in cost savings, since repair of erosion damage can be minimized.

Permanent Erosion Controls are used to reduce the potential of erosion after the construction activities are complete to ensure proper stabilization of areas disturbed by construction.

Primary erosion control strategies are to divert runoff away from unstable areas or to provide a stable surface that will resist the effects of rain and runoff. The principle measures for diverting runoff during construction include perimeter swales and dikes, and slope drains. These measures can direct flow around the active construction area or transport stormwater runoff across unstable areas.

Existing trees and vegetation should be protected to help maintain a stable ground surface and prevent loss of valuable topsoil. Where temporary vegetation is used to prevent erosion, blankets, matting and mulches can stabilize the area until the vegetation is established.

The following sections describe various erosion control measures. The types and application of the controls are summarized in Table 3-1.

Table-3-1 Summary of Temporary Erosion Control Practices

Practice	Area	Application	Notes
Interceptor Swale	< 5 ac	Used as a perimeter control or to shorten slope	
Diversion Dike	<10 ac	Used to route runoff away from disturbed areas	
Pipe Slope Drain	<5 ac	Transport runoff down steep, erodable slopes	
Channel Stabilization	NA	Conveyance of concentrated runoff	
Outlet Stabilization	NA	Prevent erosion at outlet of channel or conduit	
Level Spreader	Based on flow	Outlet device for dikes and diversions	Slope <10% and stable,
Subsurface Drain	NA	Prevent soils from becoming saturated and prevent seeps	
Vegetation	NA	Temporary and permanent stabilization of disturbed areas	Permanent vegetation required for all disturbed areas.
Cedar Mulch	NA	Temporary stabilization of disturbed Areas, or for aesthetics	
Blankets/Matting	NA	Used in channels and on steep slopes	Suggested max. slope 2H:1V for slope applications
Organic Mulch	NA	Temp. stabilization of disturbed areas	Suggested max. slope 2H:1V for slope applications
Blankets/ Socks		Stabilization in channels, around inlets, on steep slopes	
Hydraulic Mulch	NA	Stabilization of newly seeded areas	Suggested max. slope 3H:1V
Sod	NA	Immediate stabilization in channels, around inlets, or for aesthetics	
Dust Control	NA	Areas subject to on- or off-site impacts from surface/air movement of dust	

Final Stabilization is defined as all soil disturbing activities at the Site have been completed and a uniform (e.g. unevenly distributed, without large bare areas) perennial

vegetative cover with a density of 70 percent of the native background vegetative cover for the area has been established on all unpaved areas and areas not covered by permanent structures, or equivalent permanent stabilization measures, such as rip-rap, gabions, or geotextile fabric, have been employed.

Removal of vegetative cover and alteration of soil structure by clearing, grading, and compacting the surface increases an area's susceptibility to erosion. Apply stabilizing measures as soon as possible after the land is disturbed. Plan and implement temporary or permanent vegetation, mulches, or other protective practices to correspond with construction activities. Protect channels from erosive forces by using protective linings and the appropriate channel design. Table 3-2 provides guidance for appropriate stabilization of temporary and permanent open channels. Outlet stabilization and flow spreading measures must be implemented to reduce the effects of concentrated flow. Consider possible future repairs and maintenance of these practices in the design. Seeding establishes a vegetative cover on disturbed areas and is very effective in controlling soil erosion once adequate vegetative cover has been established. However, often seeding and fertilizing do not produce as thick a vegetative cover as do seed and mulch or netting. Newly established vegetation does not have as extensive a root system as existing vegetation and therefore is more prone to erosion, especially on steep slopes. Care should be taken when fertilizing to avoid untimely or excessive application. Reserved topsoil can and should be used to revegetate a site. Sod can also be used to permanently stabilize an area.

The management of land by using ground cover reduces erosion by reducing the rate of runoff and raindrop impact. In very flat, non-sensitive areas with favorable soils, stabilization may involve simply seeding and fertilizing. Erosion blankets/matting may be necessary on steeper slopes, for erodible soils, and near sensitive areas. Sediment that has escaped the site due to the failure of sediment and erosion controls should be removed as soon as possible to minimize offsite impacts. Permission should be obtained from adjacent landowners prior to offsite sediment removal.

Mulching/mats can be used to protect the disturbed area while vegetation becomes established. Mulching involves applying plant residues or other suitable materials on disturbed soil surfaces. Mulches/mats used include tacked straw, wood chips, and jute netting and are often covered by blankets or netting. Mulching alone should be used only for temporary protection of the soil surface or when permanent seeding is not feasible. The useful life of mulch varies with the material used and the amount of precipitation, but is approximately 2 to 6 months. During times of year when vegetation cannot be established, soil mulching should be applied to moderate slopes and soils that are not highly erodible. Before stabilizing an area, it is important to have installed all sediment controls and diverted runoff away from the area to be planted. Runoff may be diverted away from denuded areas or newly planted areas using dikes, swales, or pipe slope drains to intercept runoff and convey it to a permanent channel or storm drain. If runoff cannot be diverted, as is often the case with drainage channels, the use of erosion blankets/matting should be considered to protect soil and seed until vegetation becomes established. The cost of the blankets/matting is often less than the cost of regrading, reseeded, replacing topsoil and maintaining temporary erosion controls.

Table 3-2 Ranges of Shear (pounds per square foot) by Depth and Slope

Assumptions: approximately 30 inches of rainfall a year (able to sustain a "fair" vegetative cover)
 "fair soil" for vegetation growth. Soil silt, sand, clay mixture.
 "hydraulically wide" channel with generally straight alignment

Notes: Shear around bends can be greater than these values depending upon ratio of bend radius to bottom width.
 This chart is intended to be used as a quick visual guide and does not take the place of individual site analysis.
 The divisions between the different zones are estimates and may vary with differing site conditions.

Legend:	ZONE 1	SHEAR RANGE	SOIL STABILIZATION REQUIREMENTS
	ZONE 1	under 0.5 psf	none - bare soil (depending upon type of soil), vegetation required for permanent channels
	ZONE 2	up to 3 psf	grass/vegetation
	ZONE 3	up to 6-8 psf	soft armor (e.g. geosynthetic matting, erosion control blankets)
	ZONE 4	over 7 to 8 psf	hard armor (e.g. rip rap, gabion)

D (ft)	SLOPE (FT/FT)																				
	0.002	0.005	0.010	0.015	0.020	0.025	0.030	0.035	0.040	0.045	0.050	0.055	0.060	0.065	0.070	0.075	0.080	0.085	0.090	0.095	0.100
	ZONE 1										ZONE 2										
0.1	0.01	0.03	0.06	0.09	0.12	0.16	0.19	0.22	0.25	0.28	0.31	0.34	0.37	0.41	0.44	0.47	0.50	0.53	0.56	0.59	0.62
0.3	0.04	0.09	0.19	0.28	0.37	0.47	0.56	0.66	0.75	0.84	0.94	1.03	1.12	1.22	1.31	1.40	1.50	1.59	1.68	1.78	1.87
0.5	0.06	0.16	0.31	0.47	0.62	0.78	0.94	1.09	1.25	1.40	1.56	1.72	1.87	2.03	2.18	2.34	2.50	2.65	2.81	2.96	3.12
0.7	0.09	0.22	0.44	0.66	0.87	1.09	1.31	1.53	1.75	1.97	2.18	2.40	2.62	2.84	3.06	3.28	3.49	3.71	3.93	4.15	4.37
1.0	0.12	0.31	0.62	0.94	1.25	1.56	1.87	2.18	2.50	2.81	3.12	3.43	3.74	4.06	4.37	4.68	4.99	5.30	5.62	5.93	6.24
1.2	0.15	0.37	0.75	1.12	1.50	1.87	2.25	2.62	3.00	3.37	3.74	4.12	4.49	4.87	5.24	5.62	5.99	6.36	6.74	7.11	7.49
1.4	0.17	0.44	0.87	1.31	1.75	2.18	2.62	3.06	3.49	3.93	4.37	4.80	5.24	5.68	6.12	6.55	6.99	7.43	7.86	8.30	8.74
1.6	0.20	0.50	1.00	1.50	2.00	2.50	3.00	3.49	3.99	4.49	4.99	5.49	5.99	6.49	6.99	7.49	7.99	8.49	8.99	9.48	9.98
1.8	0.22	0.56	1.12	1.68	2.25	2.81	3.37	3.93	4.49	5.05	5.62	6.18	6.74	7.30	7.86	8.42	8.99	9.55	10.11	10.67	11.23
2.0	0.25	0.62	1.25	1.87	2.50	3.12	3.74	4.37	4.99	5.62	6.24	6.86	7.49	8.11	8.74	9.36	9.98	10.61	11.23	11.86	12.48
2.2	0.27	0.69	1.37	2.06	2.75	3.43	4.12	4.80	5.49	6.18	6.86	7.55	8.24	8.92	9.61	10.30	10.98	11.67	12.36	13.04	13.73
2.4	0.30	0.75	1.50	2.25	3.00	3.74	4.49	5.24	5.99	6.74	7.49	8.24	8.99	9.73	10.48	11.23	11.98	12.73	13.48	14.23	14.98
2.6	0.32	0.81	1.62	2.43	3.24	4.06	4.87	5.68	6.49	7.30	8.11	8.92	9.73	10.55	11.36	12.17	12.98	13.79	14.60	15.41	16.22
2.8	0.35	0.87	1.75	2.62	3.49	4.37	5.24	6.12	6.99	7.86	8.74	9.61	10.48	11.36	12.23	13.10	13.98	14.85	15.72	16.60	17.47
3.0	0.37	0.94	1.87	2.81	3.74	4.68	5.62	6.55	7.49	8.42	9.36	10.30	11.23	12.17	13.10	14.04	14.98	15.91	16.85	17.78	18.72
3.2	0.40	1.00	2.00	3.00	3.99	4.99	5.99	6.99	7.99	8.99	9.98	10.98	11.98	12.98	13.98	14.98	15.97	16.97	17.97	18.97	19.97
3.4	0.42	1.06	2.12	3.18	4.24	5.30	6.36	7.43	8.49	9.55	10.61	11.67	12.73	13.79	14.85	15.91	16.97	18.03	19.09	20.16	21.22
3.6	0.45	1.12	2.25	3.37	4.49	5.62	6.74	7.86	8.99	10.11	11.23	12.36	13.48	14.60	15.72	16.85	17.97	19.09	20.22	21.34	22.46
3.8	0.47	1.19	2.37	3.56	4.74	5.93	7.11	8.30	9.48	10.67	11.86	13.04	14.23	15.41	16.60	17.78	18.97	20.16	21.34	22.53	23.71
4.0	0.50	1.25	2.50	3.74	4.99	6.24	7.49	8.74	9.98	11.23	12.48	13.73	14.98	16.22	17.47	18.72	19.97	21.22	22.46	23.71	24.96
4.2	0.52	1.31	2.62	3.93	5.24	6.55	7.86	9.17	10.48	11.79	13.10	14.41	15.72	17.04	18.35	19.66	20.97	22.28	23.59	24.90	26.21
4.4	0.55	1.37	2.75	4.12	5.49	6.86	8.24	9.61	10.98	12.36	13.73	15.10	16.47	17.85	19.22	20.59	21.96	23.34	24.71	26.08	27.46
4.6	0.57	1.44	2.87	4.31	5.74	7.18	8.61	10.05	11.48	12.92	14.35	15.79	17.22	18.66	20.09	21.53	22.96	24.40	25.83	27.27	28.70
4.8	0.60	1.50	3.00	4.49	5.99	7.49	8.99	10.48	11.98	13.48	14.98	16.47	17.97	19.47	20.97	22.46	23.96	25.46	26.96	28.45	29.95
5.0	0.62	1.56	3.12	4.68	6.24	7.80	9.36	10.92	12.48	14.04	15.60	17.16	18.72	20.28	21.84	23.40	24.96	26.52	28.08	29.64	31.20
5.5	0.69	1.72	3.43	5.15	6.86	8.58	10.30	12.01	13.73	15.44	17.16	18.88	20.59	22.31	24.02	25.74	27.46	29.17	30.89	32.60	34.32
6.0	0.75	1.87	3.74	5.62	7.49	9.36	11.23	13.10	14.98	16.85	18.72	20.59	22.46	24.34	26.21	28.08	29.95	31.82	33.70	35.57	37.44
6.5	0.81	2.03	4.06	6.08	8.11	10.14	12.17	14.20	16.22	18.25	20.28	22.31	24.34	26.36	28.39	30.42	32.45	34.48	36.50	38.53	40.56
7.0	0.87	2.18	4.37	6.55	8.74	10.92	13.10	15.29	17.47	19.66	21.84	24.02	26.21	28.39	30.58	32.76	34.94	37.13	39.31	41.50	43.68
	ZONE 3										ZONE 4										

adapted from Raymond Chan & Associates

3.2.1 Interceptor Swale

Interceptor swales are used to shorten the length of exposed slope by intercepting runoff and can also serve as perimeter swales preventing off-site runoff from entering the disturbed area or prevent sediment-laden runoff from leaving the construction site or disturbed area. They may have a v-shape or be trapezoidal with a flat bottom and side slopes of 3:1 or flatter. The outflow from a swale should be directed to a stabilized outlet or sediment-trapping device. The swales should remain in place until the disturbed area is permanently stabilized. A schematic of an interceptor swale is shown in Figure 3-1.

Materials:

- Stone stabilization should be used when grades exceed 2% or velocities exceed 6 feet per second and should consist of a layer of crushed stone three inches thick, riprap or high velocity erosion control mats.
- Stabilization should extend across the bottom of the swale and up both sides of the channel to a minimum height of three inches above the design water surface elevation based on a 1-year, 3-hour storm, or the design discharge of the water conveyance structure, whichever is greater.

Installation:

- An interceptor swale should be installed across exposed slopes during construction and should intercept no more than 5 acres of runoff.
- All earth removed and not needed in construction should be disposed of in an approved spoils site so that it will not interfere with the functioning of the swale or contribute to siltation in other areas of the site.
- All trees, brush, stumps, obstructions and other material should be removed and disposed of so as not to interfere with the proper functioning of the swale.
- Swales should have a maximum depth of 1.5 feet with side slopes of 2:1 or flatter. Swales should have positive drainage for its entire length to an outlet.
- When the slope exceeds 2 percent, or velocities exceed 6 feet per second (regardless of slope), stabilization is required. Stabilization should be crushed stone placed in a layer of at least 3 inches thick or may be high velocity erosion control matting. Check dams are also recommended to reduce velocities in the swales possibly reducing the amount of stabilization necessary.
- Minimum compaction for the swale should be 90% standard proctor density.

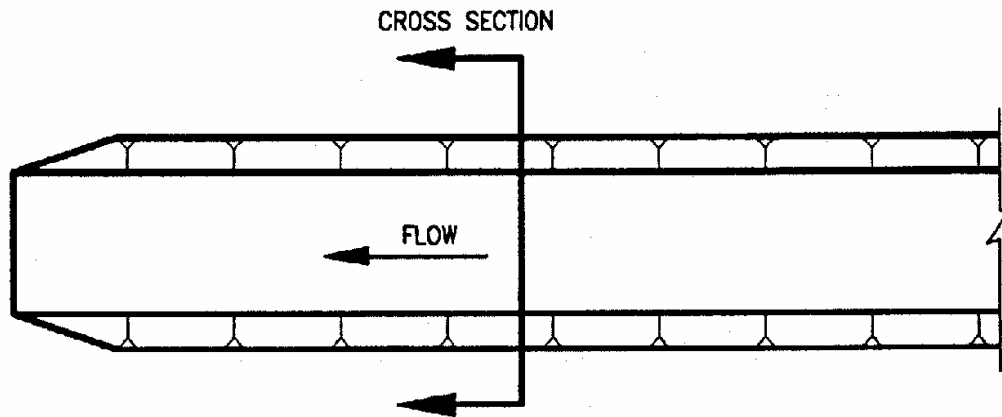

PLAN VIEW

N.T.S.

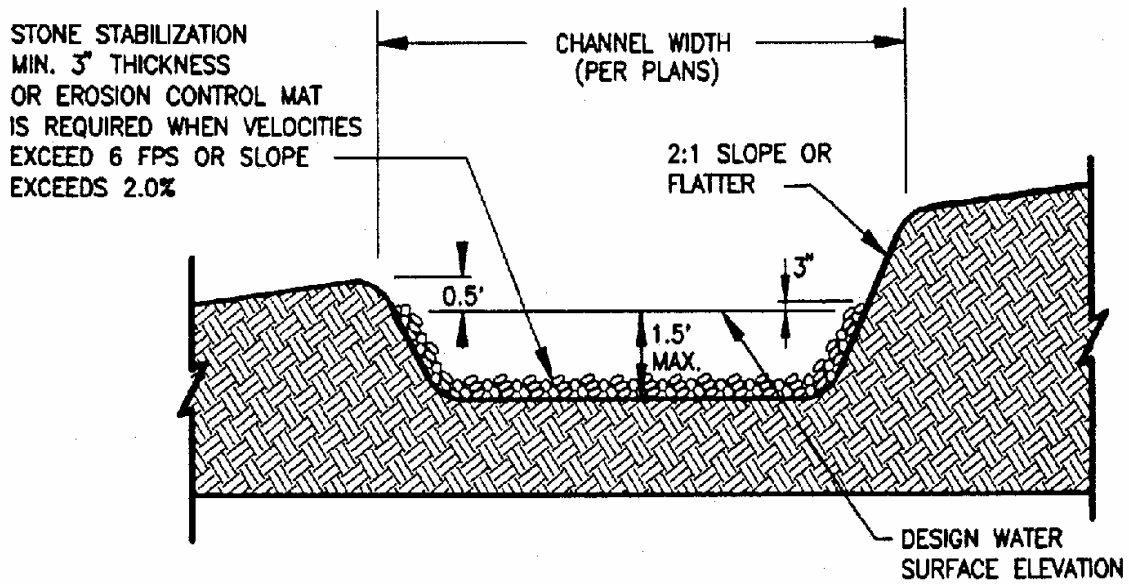

CROSS SECTION

N.T.S.

Figure 3-1 Schematic Diagram of an Interceptor Swale

Inspection and Maintenance Guidelines:

- Interceptor swales should be inspected weekly and after each rain event to locate and repair any damage to the channel or clear debris or other obstructions so as not to diminish flow capacity.
- Damage from storms or normal construction activities such as tire ruts or disturbance of swale stabilization should be repaired as soon as practical.

3.2.2 Diversion Dikes

A temporary diversion dike is a barrier created by the placement of an embankment to reroute the flow of runoff to an erosion control device or away from an open, easily erodable area. A diversion dike intercepts runoff from small upland areas and diverts it away from exposed slopes to a stabilized outlet, such as a rock berm, sandbag berm, or stone outlet structure. These controls can be used on the perimeter of the site to prevent runoff from entering the construction area. Dikes are generally used for the duration of construction to intercept and reroute runoff from disturbed areas to prevent excessive erosion until permanent drainage features are installed and/or slopes are stabilized. A schematic of a diversion dike is shown in Figure 3-2.

Materials:

- Stone stabilization (required for velocities in excess of 6 fps) should consist of riprap placed in a layer at least 3 inches thick and should extend a minimum height of 3 inches above the design water surface up the existing slope and the upstream face of the dike. Stabilization riprap should conform to the following specifications

Channel Grade	Riprap Stabilization
0.5 – 1%	4 inch rock
1.1 – 2%	6 inch rock
2.1 – 4 %	8 inch rock
4.1 – 5%	8 – 12 inch riprap

- Geotextile fabric should be a non-woven polypropylene fabric designed specifically for use as a soil filtration media with an approximate weight of 4 oz./yd²

Installation:

- Diversion dikes should be installed prior to and maintained for the duration of construction and should intercept no more than 10 acres of runoff.
- Dikes should have a minimum top width of 2 feet and a minimum height of compacted fill of 18 inches measured from the top of the existing ground at the upslope toe to top of the dike and having side slopes of 2:1 or flatter.
- The soil for the dike should be placed in lifts of 8 inches or less and be compacted to 95 % standard proctor density.
- The channel, which is formed by the dike, must have positive drainage for its entire length to an outlet.
- When the slope exceeds 2 percent, or velocities exceed 6 feet per second (regardless of slope), stabilization is required. Situations in which velocities do not exceed 6 feet per second, vegetation may be used to control erosion.

Inspection and Maintenance Guidelines:

- Swales should be inspected weekly and after each rain event to determine if silt is building up behind the dike or if erosion is occurring on the face of the dike. Locate and repair any damage to the channel or clear debris or other obstructions so as not to diminish flow capacity.
- Silt should be removed in a timely manner to prevent remobilization and to maintain the effectiveness of the control.
- If erosion is occurring on the face of the dike, the slopes of the face should either be stabilized through mulch or seeding or the slopes of the face should be reduced.
- Damage from storms or normal construction activities such as tire ruts or disturbance of stone stabilization should be repaired as soon as practical.

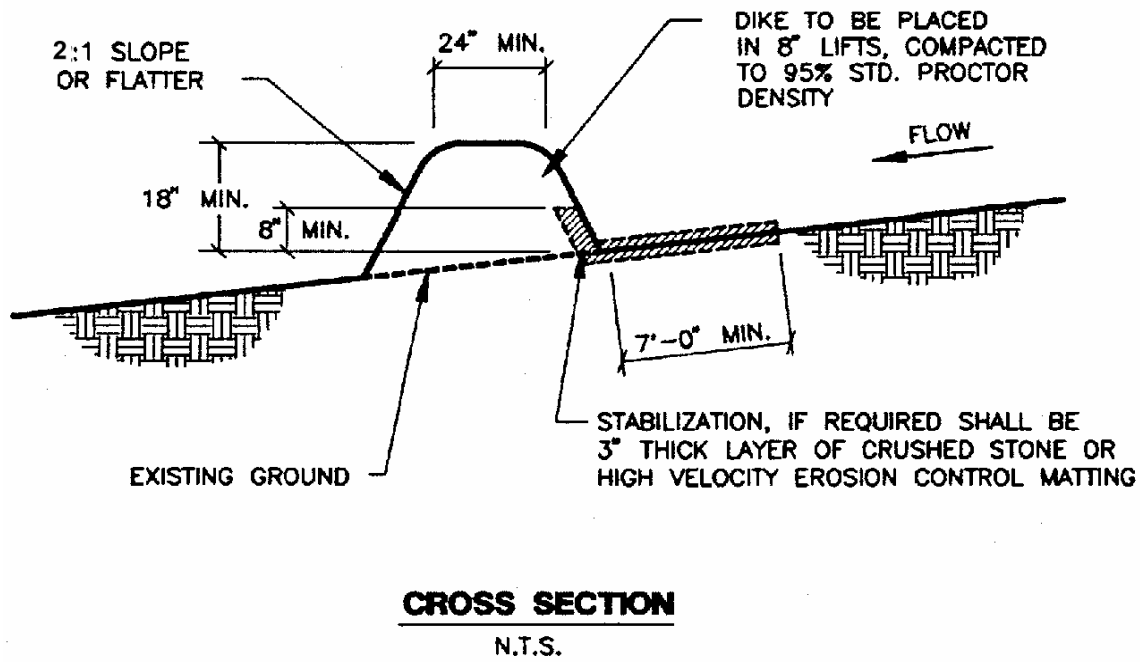
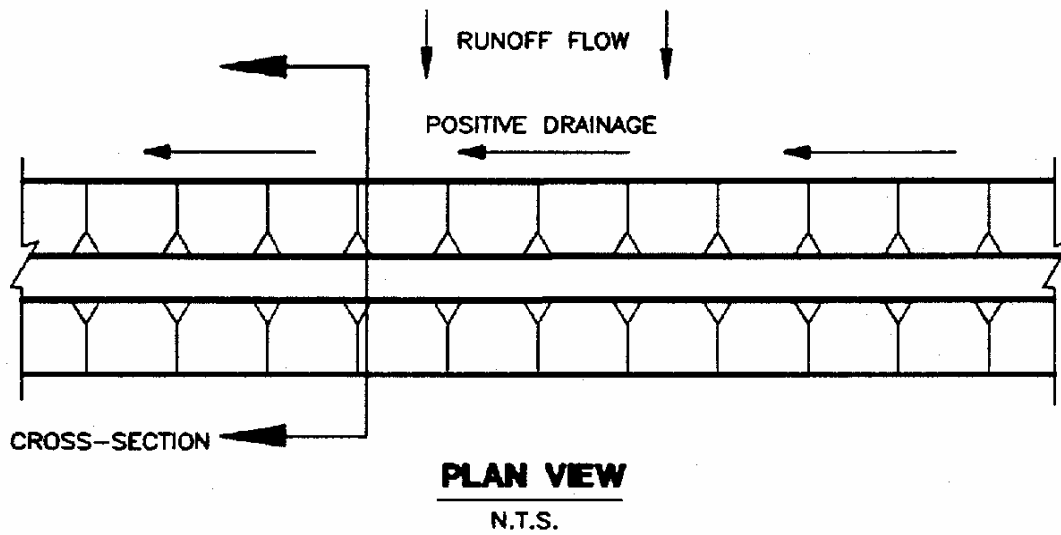

Figure 3-2 Schematic of a Diversion Dike

3.2.3 Pipe Slope Drain

A pipe slope drain is an erosion control device that combines an earthen embankment and a pipe to carry runoff over an exposed slope to a stabilized outlet apron. The maximum area contributing to any one drain should be 5 acres or less. The pipe should be sized to convey the 1-year, 3-hr storm or the design discharge of the water conveyance structure, whichever is greater. A diagram of a slope drain is shown in Figure 3-3.

Materials:

- The drain pipe may be made of any material, rigid or flexible, which is capable of conveying runoff. The drainpipe should be completely watertight so that no water leaks on to the slope to be protected.
- Riprap to be used in the outlet apron should consist of either crushed stone or broken Portland cement concrete. All stones used should weigh between 50 and 150 pounds each and should be as nearly uniform as is practical.

Installation:

- A diversion dike should be constructed at the top of the slope that is to be protected. This dike should be sized so that no runoff may overtop the dike. The soil around and under the entrance section of the drainpipe should be hand-tamped in 8-inch lifts to prevent piping failure around the inlet.
- The height of the diversion dike at the centerline of the inlet should be equal to the diameter of the pipe plus 12 inches.
- A rigid section of pipe should be installed through the dike. A standard flared-end section with an integral toe plate extending a minimum of 6-inches from the bottom of the end section should be attached to the inlet end of the pipe using watertight fittings.
- A riprap-lined apron should be excavated to accept the runoff from the pipe and dissipate the energy of the flow. The width of the bottom of the apron should be 3 times the pipe diameter and the length should be a minimum of 6 times the pipe diameter. The apron should be a minimum of 12-inches deep and lined with riprap with a thickness of at least 12 inches. The apron should be designed so that the released flow has a velocity less than 3 feet per second.

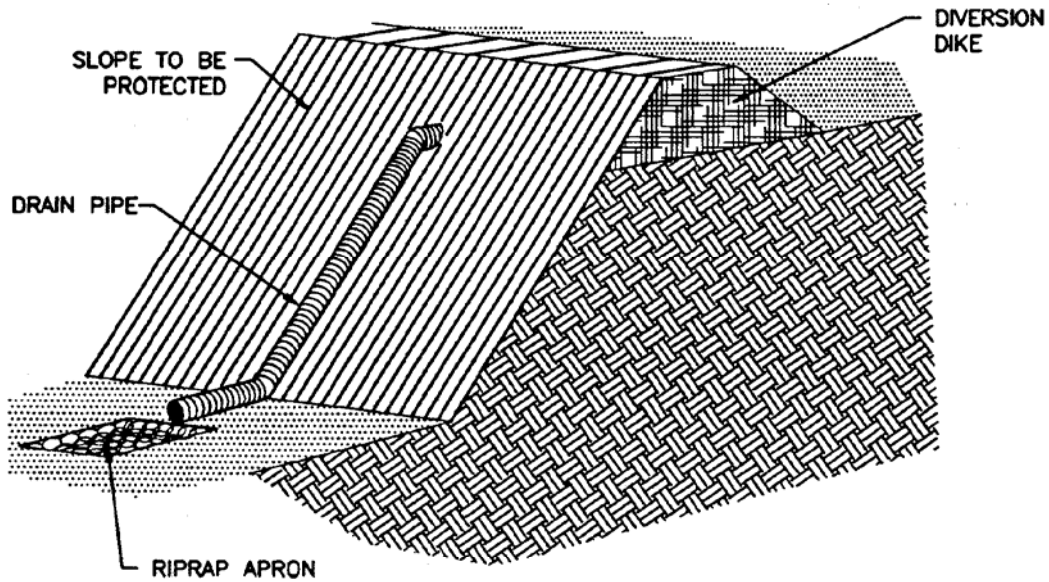

ISOMETRIC PLAN VIEW

N.T.S.

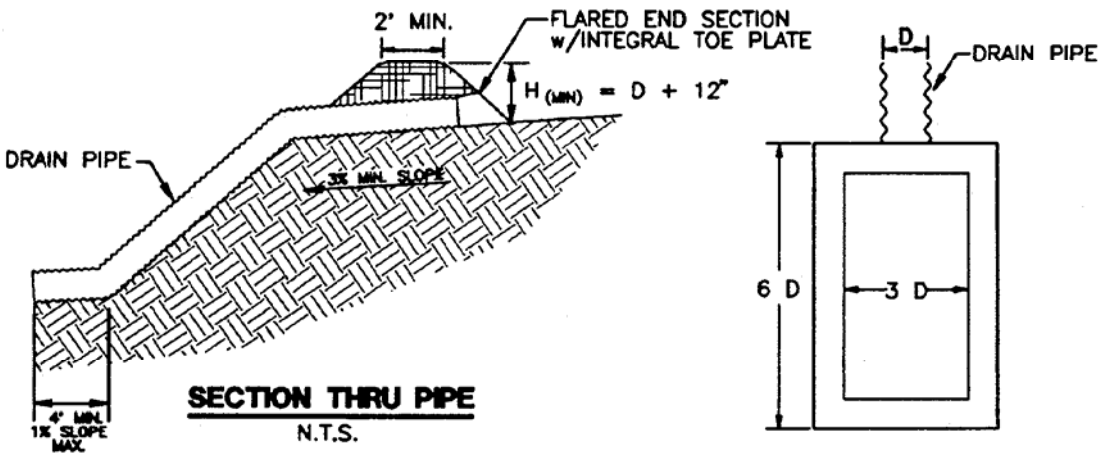

SECTION THRU PIPE

N.T.S.

RIPRAP APRON PLAN VIEW

N.T.S.

RIPRAP SHALL CONSIST OF 50 TO 150 POUND STONES PLACED IN A LAYER OF NOT LESS THAN 12 INCHES. THE DEPTH OF THE APRON SHALL EQUAL THE PIPE DIAMETER BUT IN NO CASE SHALL IT BE LESS THAN 12 INCHES.

Figure 3-3 Schematic Diagram of a Slope Drain

Inspection and Maintenance Guidelines:

- Temporary pipe slope drains should be inspected weekly and after each rain event to locate and repair any damage to joints or clogging of the pipe.
- In cases where the diversion dike has deteriorated around the entrance of the pipe, it may be necessary to reinforce the dike with sandbags or to install a concrete collar to prevent failure.
- Signs of erosion around the pipe drain should be addressed in a timely manner by stabilizing the area with erosion control mats, crushed stone, concrete or other appropriate method.

3.2.4 Channel Stabilization

Roadside ditches, drainage ditches and similar conveyances must be properly designed and stabilized to resist erosion from the design flows. New or altered channels can be lined with grass, erosion blankets/matting, rip rap revetment or other materials. The channels should be designed in accordance with local drainage criteria. Key parameters in channel design include permissible velocity, roughness coefficient, side slope, curvature, bottom width, and freeboard.

Materials:

- Grass, erosion blankets/matting, or rip rap revetment as determined by maximum velocity and shear stress. The grass species selected must be suitable for permanent application based upon the anticipated operation and maintenance of the channel or waterway.

Design Guidelines:

- The maximum permissible velocity for a grassed channel is six (6) feet per second and includes all transitions to or from channels and waterways with similar or different materials. In all cases, the velocity for design storm must be non-erosive. Shear stress may be significant even at lower velocities. Table 3-2 should be consulted to determine if armoring of the channel is appropriate. Refer to Section 3.2.11 for erosion blanket/matting guidance. Figure 3- 4 provides sizing guidelines for rip rap. U.S. Army Corps of Engineers Circular HEC-11 should be referenced for further details regarding rip rap revetment design.

- Side slopes shall be 3H:1V or flatter. Steeper slopes will require stabilization in the form of erosion blankets/matting, rip rap or structural methods. Refer to Section 3.2.11 for blankets/matting.
- The roughness coefficients selected shall be based on the degree of retardance of vegetation. Appendix 2.4 provides minimum Manning's Coefficients for channel design. The roughness coefficient shall be adjusted to reflect the relationship between the depth of flow and the typical height of the design vegetation, especially for shallow depths of flow, as well as other factors affecting channel conveyance.

Installation:

- Refer to section 3.2.8 and 3.2.11 for guidance regarding vegetation establishment and blankets/matting.

Inspection and Maintenance Guidelines:

- Channels should be inspected periodically to locate and repair any damage to the channel or clear debris or other obstructions so as not to diminish flow capacity.
- Damage from storms or vehicles should be repaired as soon as practical.

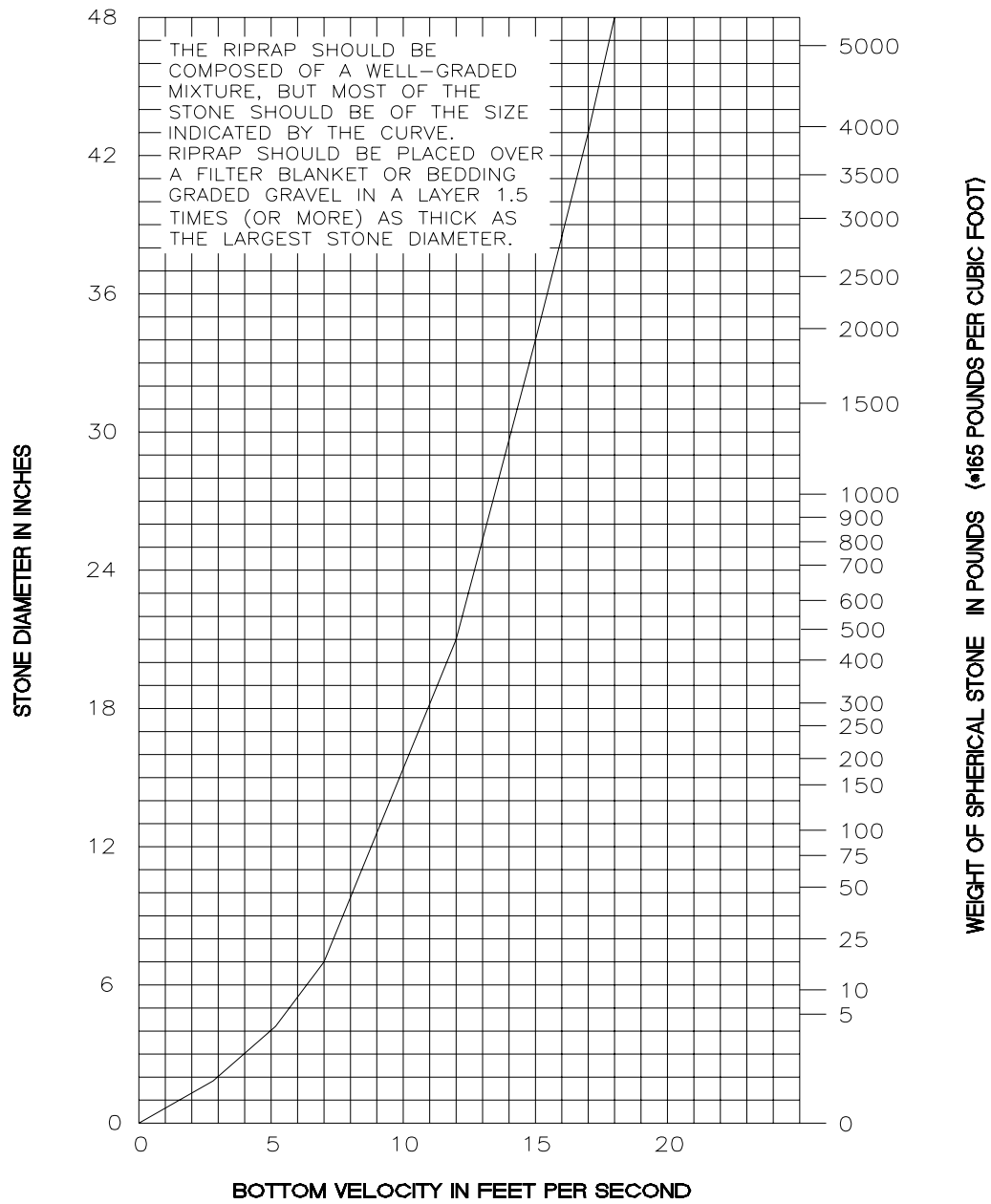

Figure 3-4 Riprap Size Selection

3.2.5 Outlet Stabilization

The goal of outlet stabilization is to prevent erosion at the outlet of a channel or conduit by reducing the velocity of flow and dissipating the energy. This practice applies where the discharge velocity of a pipe, box culvert, diversion, open channel, or other water conveyance structure exceeds the permissible velocity of the receiving channel or disposal area.

The outlets of channels, conduits, and other structures are points of high erosion potential, because they frequently carry flows at velocities that exceed the allowable limit for the area downstream. To prevent scour and undermining, an outlet stabilization structure is needed to absorb the impact of the flow and reduce the velocity to non-erosive levels. A riprap-lined apron is the most commonly used practice for this purpose because of its relatively low cost and ease of installation. The riprap apron should be extended downstream until stable conditions are reached even though this may exceed the length calculated for design velocity control.

- Riprap-stilling basins or plunge pools reduce flow velocity rapidly. They should be considered in lieu of aprons where overfalls exit at the ends of pipes or where high flows would require excessive apron length. Consider other energy dissipaters such as concrete impact basins or paved outlet structures where site conditions warrant. U.S. Army Corps of Engineers Circular HEC-14 should be referenced for further details regarding energy dissipation.

Materials:

- **Materials**—Ensure that riprap consists of a well-graded mixture of stone. Larger stone should predominate, with sufficient smaller sizes to fill the voids between the stones. The maximum stone diameter should be no greater than 1.5 times the d_{50} size. Refer to Figure 3-4 for appropriate stone size.
- **Thickness**—Make the minimum thickness of riprap 1.5 times the maximum stone diameter.
- **Stone quality**—Select stone for riprap from field stone or quarry stone. The stone should be hard, angular, and highly weather-resistant. The specific gravity of the individual stones should be at least 2.5.
- **Geotextile Fabric**—Install appropriate barrier to prevent soil movement through the openings in the riprap. The barrier should consist of a graded gravel layer or a synthetic filter cloth.

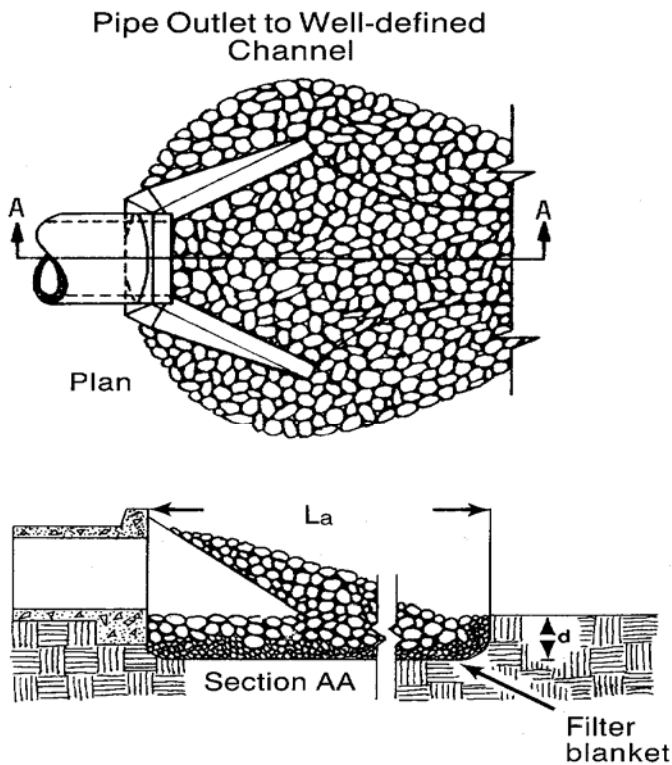
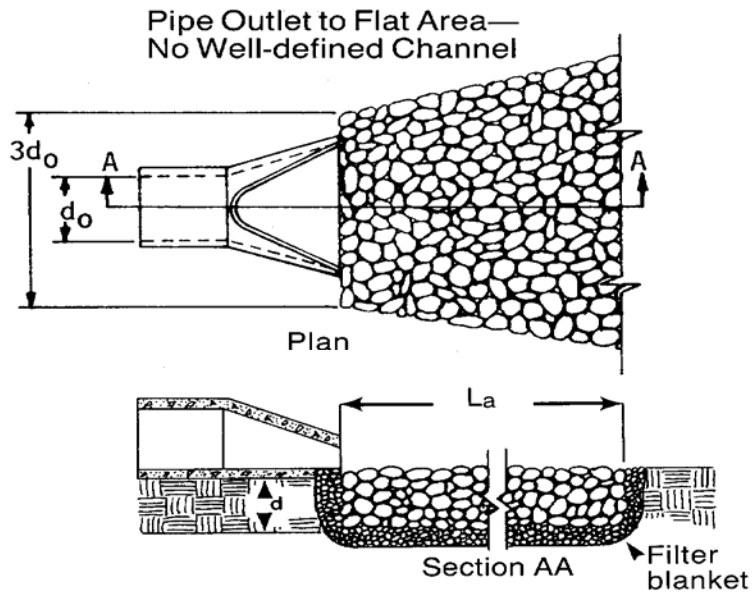

Notes

1. L_a is the length of the riprap apron.
2. $d = 1.5$ times the maximum stone diameter but not less than 6".
3. In a well-defined channel extend the apron up the channel banks to an elevation of 6" above the maximum tailwater depth or to the top of the bank, whichever is less.
4. A filter blanket or filter fabric should be installed between the riprap and soil foundation.

Figure 3-5 Riprap Outlet Design

Design Guidelines:

- Capacity— outlet stabilization should be designed in accordance with local drainage criteria.
- Apron size—If the water conveyance structure discharges directly into a well-defined channel, extend the apron across the channel bottom and up the channel banks to an elevation of 0.5 ft above the maximum tailwater depth or to the top of the bank, whichever is less (see Figure 3-4). Determine the maximum allowable velocity for the receiving stream, and design the riprap apron to reduce flow to this velocity before flow leaves the apron. Calculate the apron length for velocity control or use the length required to meet stable conditions downstream, whichever is greater. If the allowable downstream velocity cannot be readily determined, the following relationship may be used:

Equation 3.1 **$La = 0.5 V * D$**

Where: La = Length of rip rap apron, ft
 V = Culvert discharge velocity, ft/s
 D = diameter or height of culvert, ft

- Grade—Ensure that the apron has zero grade. There should be no over-fall at the end of the apron; that is, the elevation of the top of the riprap at the downstream end should be the same as the elevation of the bottom of the receiving channel or the adjacent ground if there is no channel.
- Alignment—The apron should be straight throughout its entire length, but if a curve is necessary to align the apron with the receiving stream, locate the curve in the upstream section of riprap.

Installation:

- Ensure that the subgrade for the fabric and riprap follows the required lines and grades shown in the plan. Compact any fill required in the subgrade to the density of the surrounding undisturbed material. Low areas in the subgrade on undisturbed soil may also be filled by increasing the riprap thickness.
- The riprap and fabric must conform to the specified grading limits shown on the plans.
- Filter cloth must be properly protected from punching or tearing during installation. Repair any damage by removing the riprap and placing another piece of filter cloth over the damaged area. All connecting joints should overlap a minimum of 1 ft. If the damage is extensive, replace the entire filter cloth.
- Riprap may be placed by equipment, but take care to avoid damaging the fabric.

- The minimum thickness of the riprap should be 1.5 times the maximum stone diameter.
- Riprap may be field stone or rough quarry stone. It should be hard, angular, highly weather-resistant and well graded.
- Construct the apron on zero grade with no overfall at the end. Make the top of the riprap at the downstream end level with the receiving area or slightly below it.
- Ensure that the apron is properly aligned with the receiving stream and preferably straight throughout its length. If a curve is needed to fit site conditions, place it in the upper section of the apron.
- Immediately after construction, stabilize all disturbed areas with vegetation.

Inspection and Maintenance Guidelines:

- Inspect riprap outlet structures after heavy rains to see if any erosion around or below the riprap has taken place or if stones have been dislodged. Immediately make all needed repairs to prevent further damage.

3.2.6 Level Spreaders

A level spreader is used to convert concentrated runoff into sheet flow and release it uniformly onto areas stabilized by existing vegetation. Sheet flow conditions are required by the Highland Lakes Watershed Ordinance prior to runoff entering a vegetative filter strip or a creek buffer. During the construction process, level spreaders can be used where there is a need to divert stormwater away from disturbed areas to avoid overstressing erosion control measures or where storm runoff can be released in sheet flow down a stabilized slope without causing erosion.

This section presents a flow spreader consisting of an excavated depression constructed at zero grade across a slope with a level lip. Multiple options are provided for the level lip and include a grass hedge row, reinforced vegetation, a rock berm, and a rigid timber lip. Refer to Figures 3-6 and 3-7 for a schematic and cross sections of these various options. Other flow spreader designs can be used as long as they convert concentrated runoff to sheet flow as defined in this section.

Sheet flow is defined at a flow depth of less than 0.2 feet or 2.4 inches and a velocity of less than one (1) foot per second during the peak flowrate from the 1-year, 3-hour storm event under fully-developed conditions. The hydrologic and hydraulic reference tables in Appendix 2.4 can be used with the Rational Method to determine the fully-developed peak flow rate. The following equation based on the Continuity Equation ($Q=VA$) can be used to determine the required flow spreader length.

Equation 3.2 $L = 5Q_{1\text{Year-Dev}}$

Where: L = minimum required length of flow spreader (ft)
 Q_{1YR} = fully-developed peak flow rate for the 1-yr, 3-hr storm event (cfs)

Particular care should be taken to construct the outlet lip at a level elevation in a stable, undisturbed soil. Any depression in the lip will concentrate the flow, potentially resulting in erosion. Under higher design flow conditions, a rigid outlet lip design should be used to create the desired sheet flow conditions. Runoff water containing high sediment loads must be treated in a sediment-trapping device before being released to a level spreader.

Installation:

- Level spreaders should be constructed on undisturbed soil (not fill material)
- The entrance to the spreader should be shaped in such a manner as to insure that runoff enters directly onto the 0% grade channel
- Construct a transition section from the diversion channel to blend smoothly to the width and depth of the spreader.
- The level lip should be constructed at 0% grade to insure uniform spreading of stormwater runoff.
- Immediately after its construction, establish vegetation along the entire disturbed area of the spreader. A vegetative cover density of 80% with no large bare areas is required.
- Level spreader to be staked along a contour prior to construction

Inspection and Maintenance Guidelines:

- The level spreader should be inspected annually and repairs made, if required.
- Level spreader lip should remain at 0% slope to allow proper function of measure.
- The contractor should avoid the placement of any material on and prevent construction traffic across the structure. If the measure is damaged by construction traffic, it should be repaired immediately.

LEVEL SPREADER

ZERO GRADE ACROSS A SLOPE WITH
MULTIPLE LEVEL LIP OPTIONS

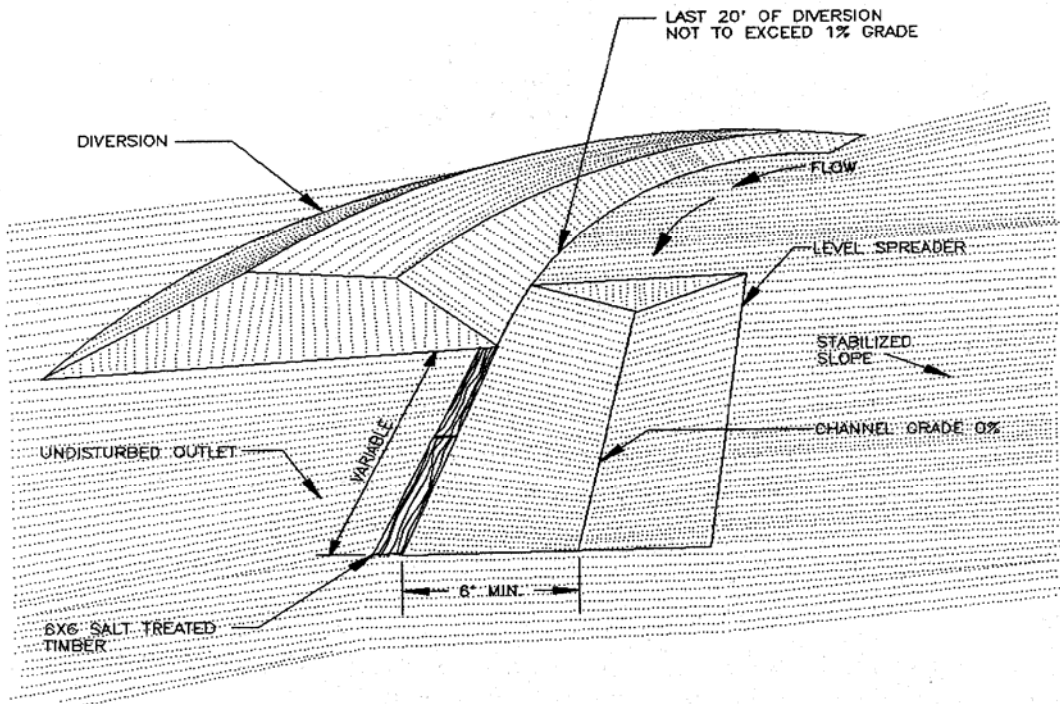
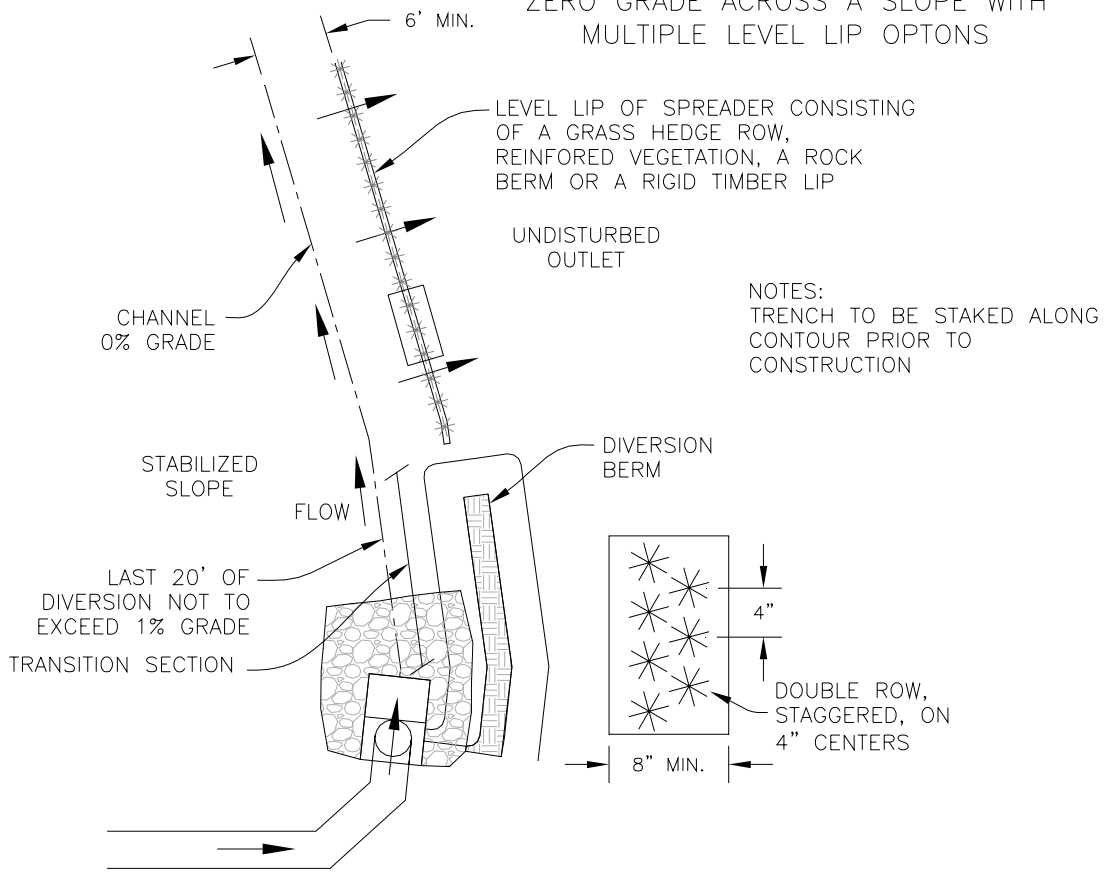
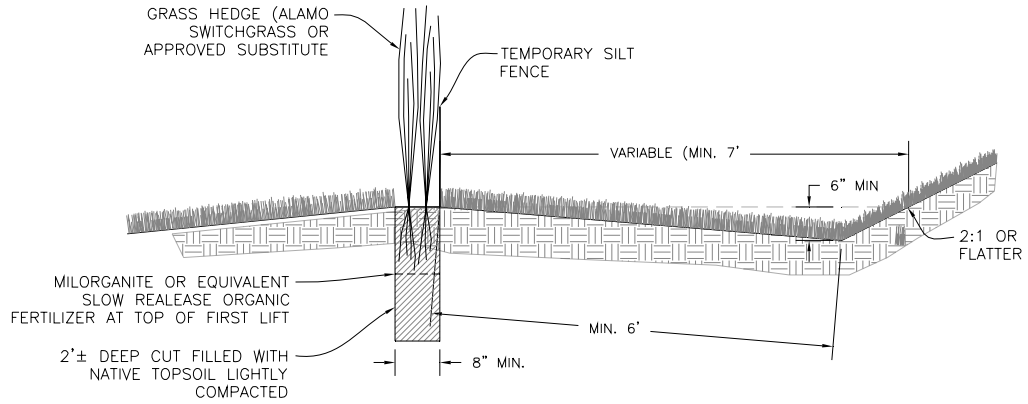
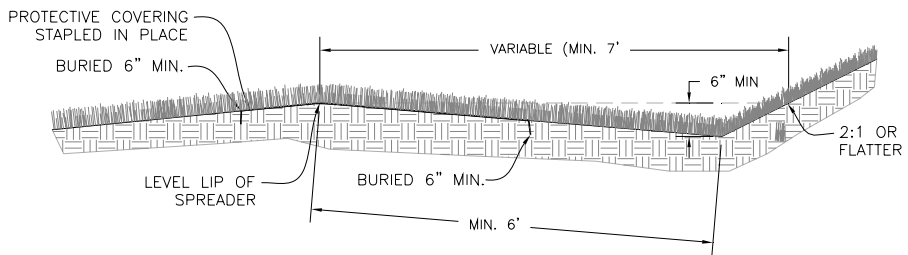

Figure 3-6: Level Spreader Schematic & Perspective



LEVEL SPREADER WITH GRASS HEDGE ROW



LEVEL SPREADER WITH REINFORCED VEGETATED LIP

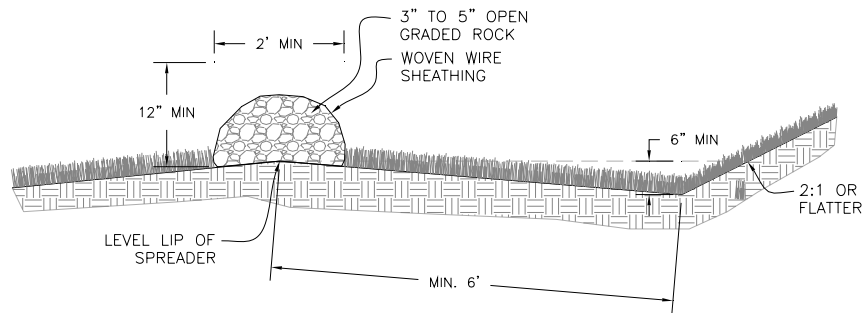

LEVEL SPREADER WITH ROCK BERM LIP

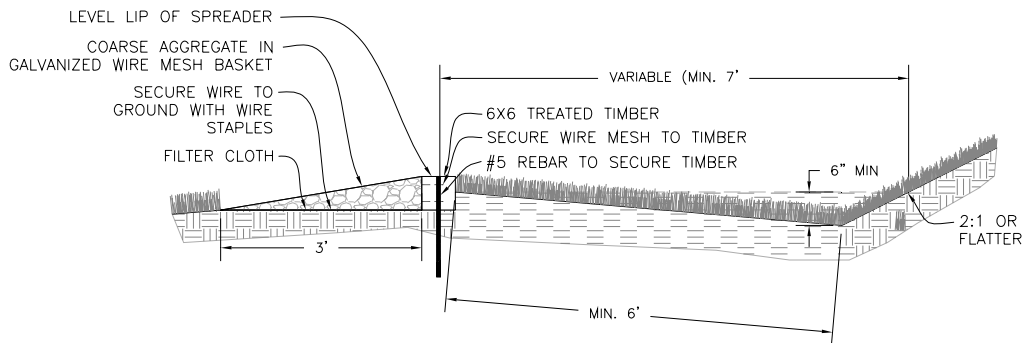

LEVEL SPREADER WITH RIGID TIMBER LIP

Figure 3-7: Level Spreader Lip Options

3.2.7 Subsurface Drains

A subsurface drain is a perforated conduit such as pipe, tubing or tile installed beneath the ground to intercept and convey ground water. The main purposes are to: prevent sloping soils from becoming excessively wet and subject to sloughing, improve the quality of the growth medium in excessively wet areas by lowering the water table (see Figure 3-8), or drain stormwater detention areas or structures.

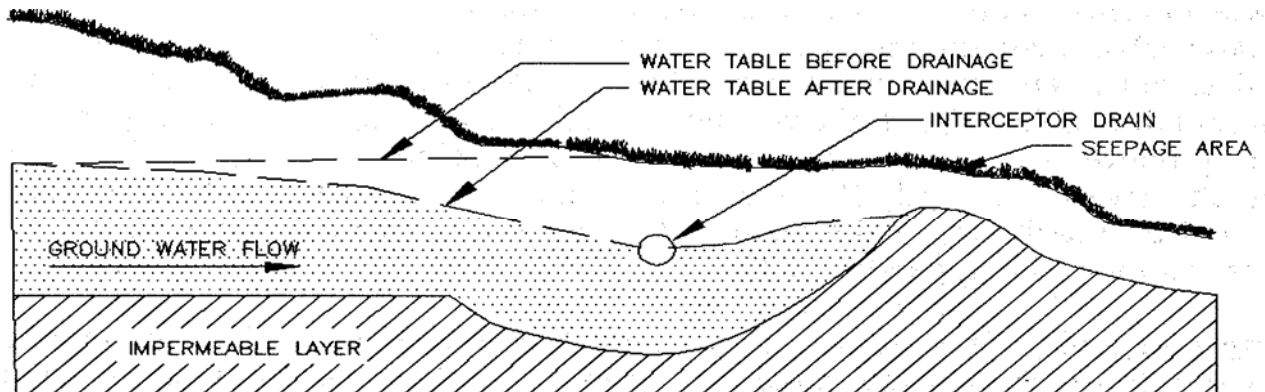

Figure 3-8 Effect of Subsurface Drain

This measure is appropriate wherever excess water must be removed from the soil. The soil must be deep and permeable enough to allow an effective system to be installed. Either a gravity outlet must be available or pumping must be provided. These standards do not apply to foundation drains.

Subsurface drainage systems are of two types, relief drains and interceptor drains. Relief drains are used either to lower the water table in order to improve the growth of vegetation, or to remove surface water. They are installed along a slope and drain in the direction of the slope. They can be installed in a gridiron pattern, a herringbone pattern, or a random pattern (see Figure 3-9).

Interceptor drains are used to remove water as it seeps down a slope to prevent the soil from becoming saturated and subject to slippage. They are installed across a slope and drain to the side of the slope. They usually consist of a single pipe or series of single pipes instead of a patterned layout.

Materials:

Acceptable materials for subsurface drains include perforated, continuous closed-joint conduits of corrugated plastic, concrete, corrugated metal, asbestos cement, and bituminous fiber. The strength and durability of the pipe should meet the requirements of the site in accordance with the manufacturer's specifications.

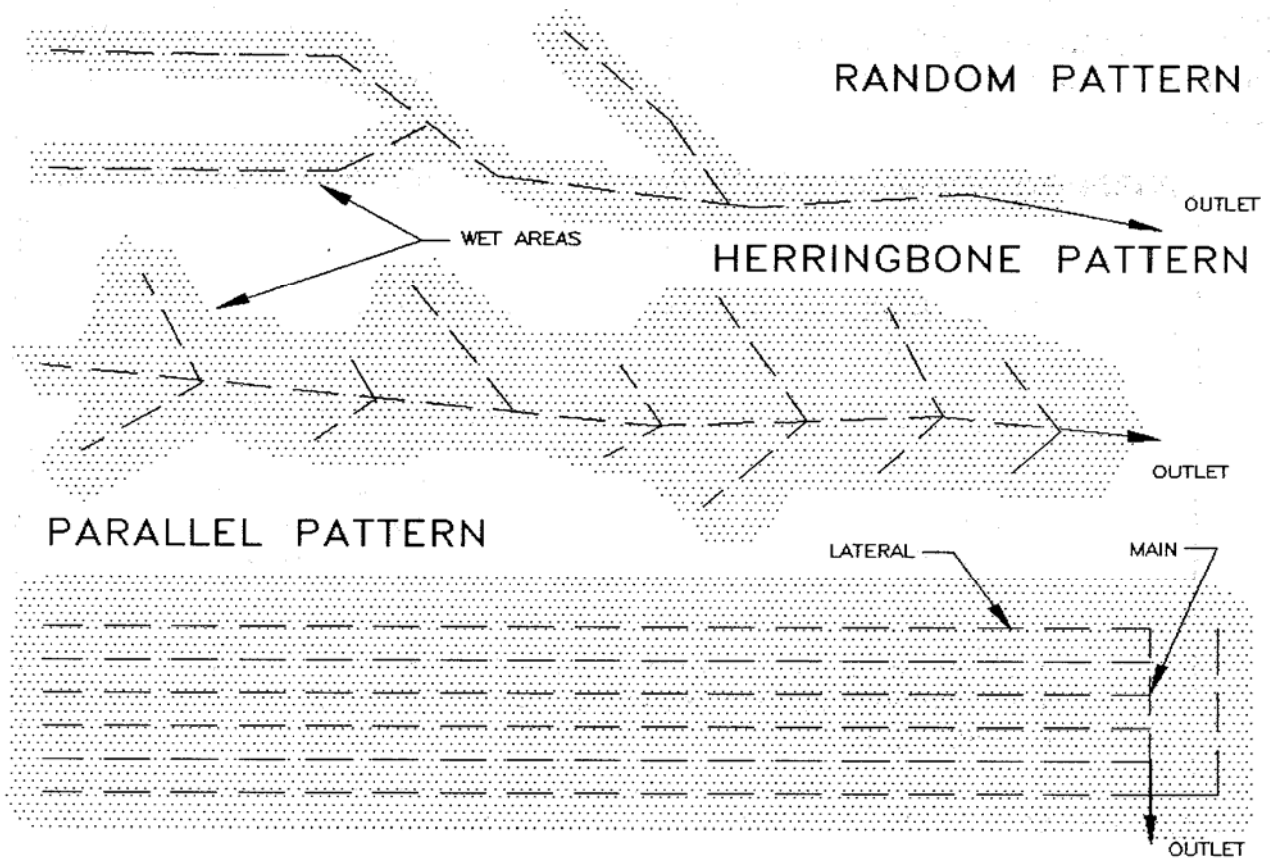

Figure 3-9 Subsurface Drainage Patterns

General Installation Requirements:

- The trench should be constructed on a continuous grade with no reverse grades or low spots.
- Soft or yielding soils under the drain should be stabilized with gravel or other suitable material.
- Deformed, warped, or otherwise unsuitable pipe should not be used. The minimum diameter for a subsurface drain should be 4 inches.
- Envelopes or filter material should be placed as specified with at least 3 inches of material on all sides of the pipe.
- The trench should be backfilled immediately after placement of the pipe. No sections of pipe should remain uncovered overnight or during a rainstorm. Backfill material should be placed in the trench in such a manner that the drain pipe is not displaced or damaged.

Relief Drain Installation:

- Relief drains should be located through the center of wet areas. They should drain in the same direction as the slope.
- Relief drains installed in a uniform pattern should remove a minimum of 1 inch of groundwater in 24 hours (0.042 cfs/acre). Relief drains installed in a random pattern should remove a minimum of 1.5 cfs/1000 feet of length. The design capacity should be increased accordingly to accommodate any surface water which enters directly into the system (see Figure 3-9).
- Relief drains installed in a uniform pattern should have equal spacing between drains and the drains should be at the same depth. Maximum depth is limited by the allowable load on the pipe, depth to impermeable layers in the soil, and outlet requirements. The minimum depth is 24 inches under normal conditions. Twelve inches is acceptable where the drain will not be subject to equipment loading. Spacing between drains is dependent on soil permeability and the depth of the drain. In general, however, a depth of 3 feet and a spacing of 50 feet will be adequate.
- The minimum velocity required to prevent silting is 1.4 ft/sec. The line should be graded to achieve at least this velocity. Steep grades should be avoided, however.
- Envelopes should be used around all drains for proper bedding and improved flow of groundwater into the drain. The envelope should consist of 3 inches of aggregate placed completely around the drain. The stone should be encompassed by a filter cloth separator to prevent the migration of surrounding soil particles into the drain (see 3-9). Filter cloth must be designed specifically for soil filtration
- The outlet of the subsurface drain should empty into a channel or some other watercourse that will remove the water from the outlet. It should be above the mean water level in the receiving channel. It should be protected from erosion, undermining, damage from periods of submergence, and the entry of small animals into the drain.

Interceptor Drain Installation:

- Interceptor drains should remove a minimum of 1.5 cfs/1000 feet of length. This value should be increased for sloping land. In addition, if a flowing spring or surface water enters directly into the system, this flow must be accommodated and the design capacity should be increased accordingly to take care of this flow.
- The depth of installation of an interceptor drain is influenced mainly by the depth to which the water table is to be lowered. The maximum depth is limited by the

allowable load on the pipe and the depth to an impermeable layer. Minimum depth should be the same as for relief drains.

- One interceptor drain is usually sufficient; however, if multiple drains are to be used, determining the required spacing can be difficult. The best approach is to install the first drain - then if seepage or high water table problems occur down slope, install an additional drain a suitable distance down slope.

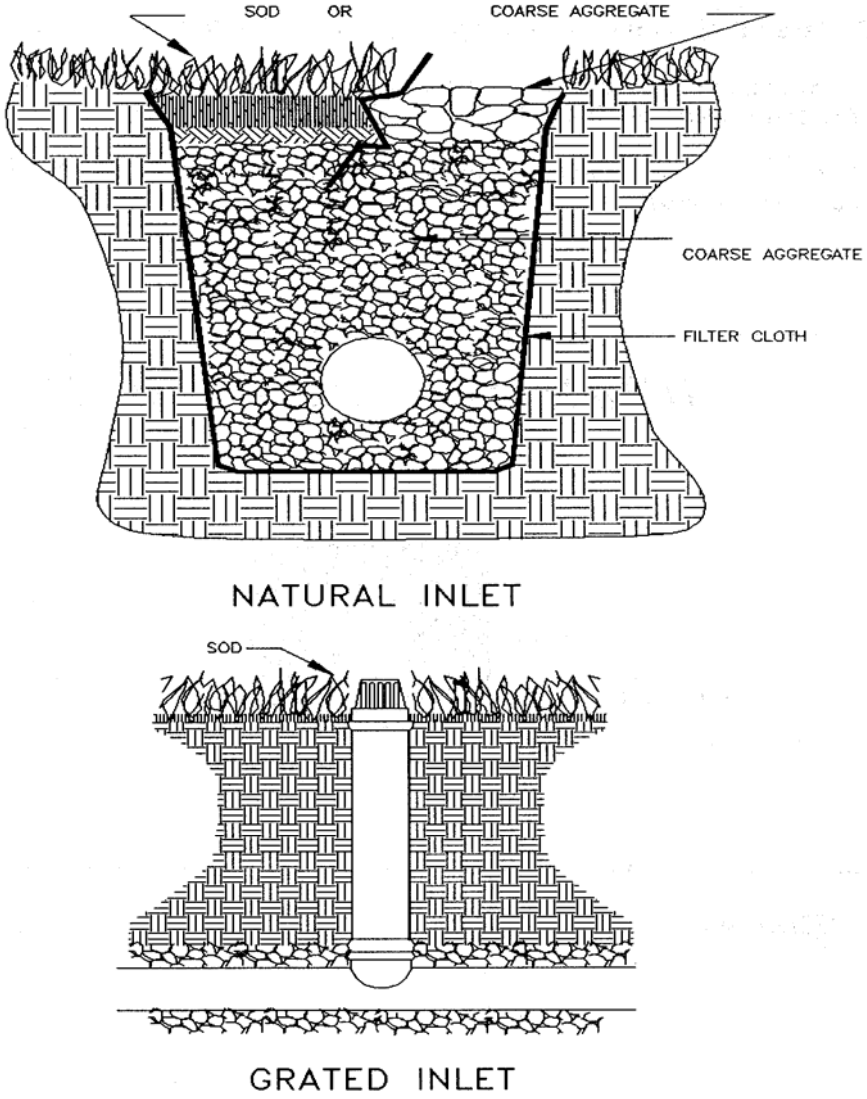

Figure 3-10 Surface Inlets for Subsurface Drains

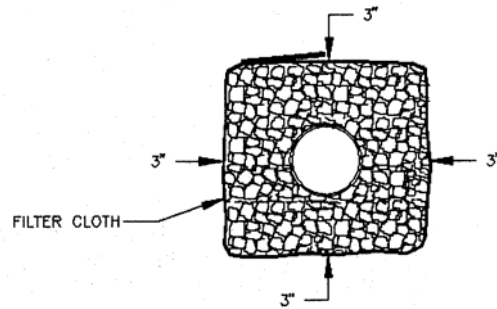

Figure 3-11 Subsurface Drain Envelope

Inspection and Maintenance Guidelines:

- Subsurface drains should be checked weekly and after rainfall events to ensure that they are free flowing and not clogged with sediment.
- The outlet should be kept clean and free of debris.
- Surface inlets should be kept open and free of sediment and other debris.
- Trees located too close to a subsurface drain often clog the system with their roots. If a drain becomes clogged, relocate the drain.
- Where heavy vehicles cross drains, the line should be checked to ensure that it is not crushed.

3.2.8 Vegetation

Vegetation is used as a temporary or permanent stabilization technique for areas disturbed by construction, but not covered by pavement, buildings, or other structures. As a temporary control, vegetation can be used to stabilize stockpiles and barren areas that are inactive for long periods of time.

Vegetative techniques can and should apply to every construction project with few exceptions. Vegetation effectively reduces erosion in swales, stockpiles, berms, mild to medium slopes, and along roadways.

Other techniques may be required to assist in the establishment of vegetation. These other techniques include erosion control matting, mulches, surface roughening, swales and dikes to direct runoff around newly seeded areas, and proper grading to limit runoff velocities during construction. (NCTCOG, 1993b)

Materials:

The type of vegetation used on a site is a function of the season and the availability of water for irrigation. For areas that are not irrigated, the year can be divided into two temporary planting seasons and one season for planting of permanent warm weather groundcovers. These periods are shown in Figure 3-11 for Burnet, Travis, and Llano Counties. Appropriate temporary and permanent vegetation for these areas are shown in Table 3-3 and 3-4 respectively.

Bermuda grass has been traditionally specified for permanent vegetation, with the addition of Cereal or Winter Rye when seeding during cold months to provide temporary cover until the onset of the growing season for Bermuda grass. TXDOT has had success with native grasses and wildflowers and recent testing indicates that native species are more drought tolerant and equally effective in terms of erosion control. A native seed mixture containing Texas Wintergrass can be used throughout the year. Reuse of native topsoil stripped off and stockpiled during site clearing and grubbing provides an effective means to reestablish native vegetation as the topsoil will contain seed and root material. County agricultural extension agents are a good source for suggestions for other types of vegetation. All seed should be high quality, U.S. Dept. of Agriculture certified seed.

Installation:

- Interim or final grading must be completed prior to seeding, minimizing all steep slopes. In addition, all necessary erosion structures such as dikes, swales, diversions, should also be installed.
- Seedbed should be well pulverized, loose, and uniform.
- A soil analysis is recommended to determine the amount of fertilization required. When seeding with non-native species, fertilizer may be applied at the rate of 40 pounds of nitrogen and 40 pounds of phosphorus per acre, which is equivalent to about 1.0 pounds of nitrogen and phosphorus per 1000 square feet. Compost can be used instead of fertilizer and applied at the same time as the seed.
- Seeding rates should be as shown in Table 3-3 and 3-4 or as recommended by the county agricultural extension agent.
- The seed should be applied uniformly with a cyclone seeder, drill, cultipacker seeder or hydroseeder (slurry includes seed, fertilizer and binder). Seed may also be combined with hydraulic mulch (see Section 3.2.13) and applied simultaneously.
- Protect the seedbed with a mulch layer to conserve soil moisture. Compost, hay or straw are recommended. Hay or straw mulch should be applied at a rate of approximately 2 tons per acre. Organic Compost mulch application is covered in section 3.2.12. Hay or straw mulch should be anchored by crimping or application of an organic tackifier.

- Protect slopes that are steeper than 3H:1V with appropriate erosion blankets/matting as described in the section 3.2.11 to prevent loss of soil and seed.
- Evaluate velocity and shear stress for drainage channels, diversion dikes and swales and protect with erosion blankets/matting as described in section 3.2.11.

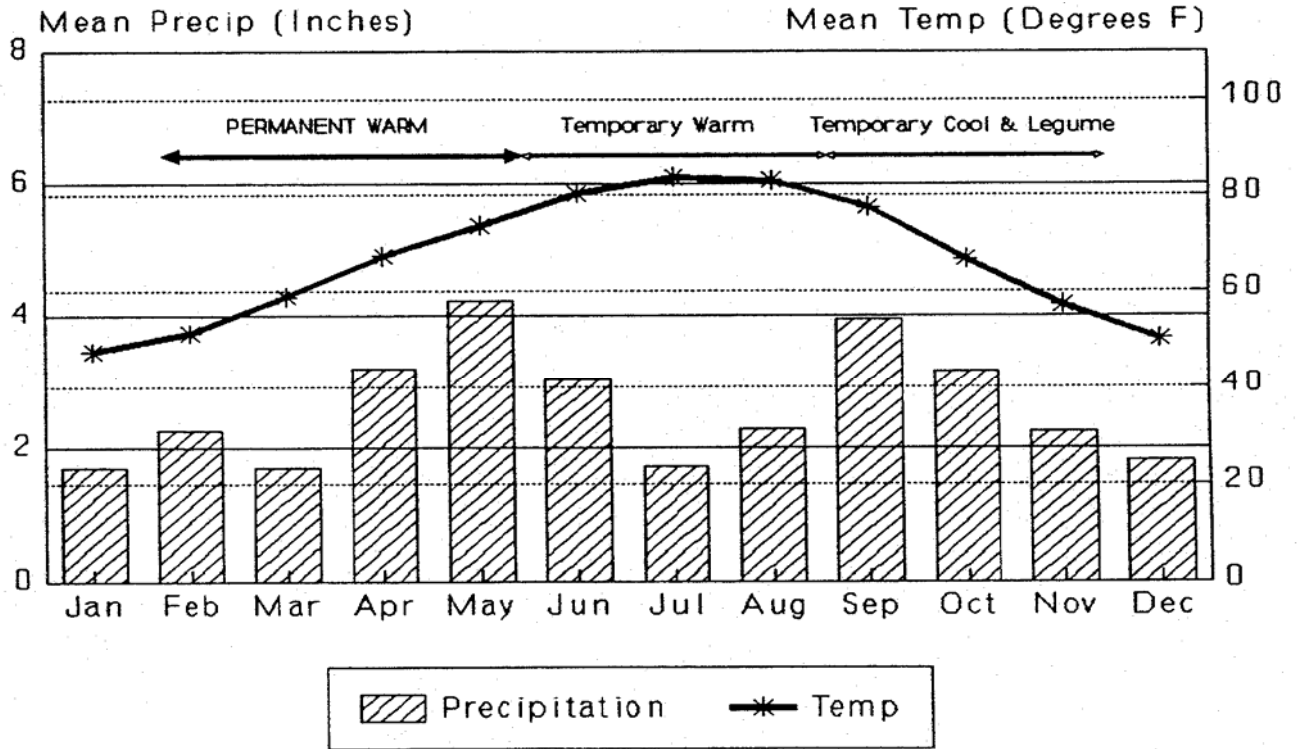

Figure 3-12 Planting Dates for Burnet, Travis, and Llano Counties

Table 3-3 Temporary Seeding for Burnet, Travis, and Llano Counties

Dates	Climate	Species (lb/ac)	
Sept 1 to Nov 30	Temporary Cool Season	Oats (<i>Avena sativa</i>)	21.0
		Wheat (Red, Winter) (<i>Triticum aestivum</i>)	30.0
		Total	51.0
		Oct 1 to Mar 30	Temporary Cool Season
May 15 to Aug 31	Temporary Warm Season	Foxtail Millet (<i>Setaria italica</i>)	30.0

Table 3-4 Permanent Seeding for Burnet, Travis, and Llano Counties

Dates	Climate	Species (lb/ac)	
Year Round	Permanent Cool/Warm Season (Native Species)	Purple three-awn (<i>Aristida purpurea</i>)	1.4
		Sideoats grama (<i>Bouteloua curtipendula</i>)	2.0
		Silver bluestem (<i>Bothriochloa laguroides</i>)	6.0
		Buffalograss (<i>Buchloe dactyloides</i>)	1.4
		Canadian wildrye (<i>Elymus Canadensis</i>)	1.4
		Engelmann's daisy (<i>Engelmannia pinnatifida</i>)	0.6
		Green sprangletop (<i>Leptochloa dubia</i>)	2.6
		Mexican hat (<i>Ratibida columnifera</i>)	1.0
		Little bluestem (<i>Schizachyrium scoparium</i>)	1.8
		Indiangrass (<i>Sorghastrum nutans</i>)	1.8
		Texas Wintergrass (<i>Nassella leucotricha</i>)	15.0
	Total	35.0	
Mar 30 to Oct 1	Permanent Warm Season	Bermuda (<i>Cynodon dactylon</i>)(hulled)	45.0
Oct 1 to Mar 30	Permanent Cool/Warm Season	Bermuda (<i>Cynodon dactylon</i>) (unhulled)	70.0
		Cereal Rye (<i>Secale cereale</i>)	90.0
	Total	160.0	

3.2.9 Irrigation

Temporary irrigation should be provided according to the schedule described below, or to replace moisture loss to evapotranspiration (ET), whichever is greater. Significant rainfall (on-site rainfall of ½” or greater) may allow watering to be postponed until the next scheduled irrigation. All automatic irrigation systems should have a dual sensor rain shut of switch that automatically shuts off the irrigation systems when rain begins to fall and turns on the system if less than ½ inch of rain occurs.

Time Period	Irrigation Amount and Frequency
Within 2 hours of installation	Irrigate entire root depth, or to germinate seed
During the next 10 business days	Irrigate entire root depth every Monday, Wednesday, and Friday
During the next 30 business days or until Substantial Completion	Irrigate entire root depth a minimum of once per week, or as necessary to ensure vigorous growth
During the next 4 months or until Final Acceptance of the Project	Irrigate entire root depth once every two weeks, or as necessary to ensure vigorous growth

Refer to figure 3-13, below, for average rainfall/ET data for the Austin area. This data shall serve as a guide to the overall watering regime; however, actual frequency and amount of irrigation water used shall be weather-dependent.

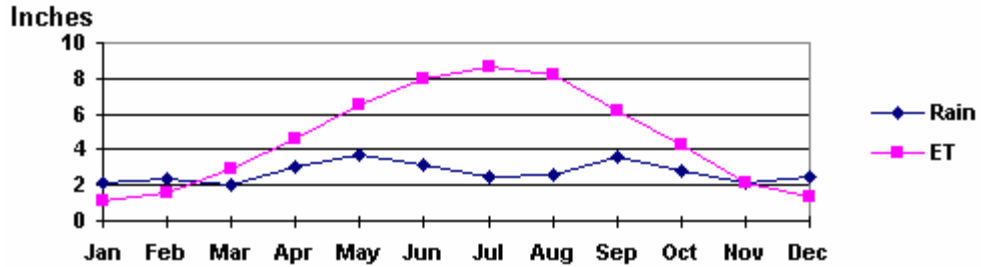

Figure 3-13 Rainfall/ET Data for Austin

If cool weather induces plant dormancy, water only as necessary to maintain plant health. Irrigate in a manner that will not erode the topsoil but will sufficiently soak the entire depth of roots.

Inspection and Maintenance Guidelines:

- Newly applied vegetation should be inspected weekly and after each rain event to locate and repair any erosion.
- Erosion from storms or other damage should be repaired as soon as practical by regrading the area and applying new seed.
- If the vegetated cover is less than 80%, the area should be reseeded.

3.2.10 Cedar Mulch

Cedar Mulch can be used as an aid to control erosion on critical sites during land clearing and periods of construction when re-vegetation is not practical. The best results are obtained from rough, long cut (3 - 6 inch) mulching. The most common uses are as berms at the bottom of long, steep slopes and as a blanket in channels where designed flow does not exceed 3.5 feet per second; on interceptor swales and diversion dikes when design flow exceeds 6 feet per second; and on long slopes where rill erosion hazard is high and planting is likely to be slow to establish adequate protective cover.

Materials:

Cedar Mulch is easily obtained as a by-product of land clearing operations. It can also be a cost saving item because it is a recycled material and does not have to be removed from the site.

Inspection and Maintenance Guidelines:

- Cedar Mulch should be inspected weekly and after each rain event to locate and repair any erosion.
- Erosion from storms or other damage should be repaired as soon as practical by applying new layers of mulch.

3.2.11 Blankets and Matting

Blankets and matting material can be used as an aid to control erosion in critical areas during the establishment period of protective vegetation. The most common uses are: in channels, interceptor swales and diversion dikes where designed flow exceeds 6 feet per second or where shear stresses exceed erosion resistance of the channel surface; on short, steep slopes where erosion hazard is high, where planting is likely to be slow to establish adequate protective cover; and on stream banks where moving water is likely to wash out new vegetative plantings. Shear stresses are used in selection of the appropriate channel protection. Table 3-2 should be consulted in addition to the referenced velocity limits to determine the appropriate level of armoring for a channel, swale or dike

Blankets and matting can also be used to create erosion stops on steep, highly erodible watercourses. Erosion stops should be placed approximately 3 feet down channel from point of entry of a concentrated flow such as from culverts, tributary channels or diversions or at points where a change in gradient or course of channel occurs. Spacing of erosion stops on long slopes will vary, depending on the erodibility of the soil and velocity and volume of flow. Erosion stops are placed beneath blankets and matting.

Biodegradable rolled erosion control products (RECPs) are typically composed of jute fibers, curled wood fibers, straw, coconut fiber, or a combination of these materials. In order for an RECP to be considered 100% biodegradable, the netting, sewing or adhesive system that holds the biodegradable mulch fibers together must also be biodegradable.

Jute is a natural fiber that is made into a yarn that is loosely woven into a biodegradable mesh. It is designed to be used in conjunction with vegetation and has longevity of approximately one year. The material is supplied in rolled strips, which should be secured to the soil with U-shaped staples or stakes in accordance with manufacturers' recommendations.

Excelsior (curled wood fiber) blanket material should consist of machine produced mats of curled wood excelsior with 80 percent of the fiber 6 in. or longer. The excelsior blanket should be of consistent thickness. The wood fiber must be evenly distributed over the entire area of the blanket. The top surface of the blanket should be covered with a photodegradable extruded plastic mesh. The blanket should be smolder resistant without the use of chemical additives and should be non-toxic and non-injurious to plant and animal life.

Straw blanket should be machine produced mats of straw with a lightweight biodegradable netting top layer. The straw should be attached to the netting with biodegradable thread or glue strips. The straw blanket should be of consistent thickness. The straw should be evenly distributed over the entire area of the blanket.

Wood fiber blanket is composed of biodegradable fiber mulch with extruded plastic netting held together with adhesives. The material is designed to enhance re-vegetation. The material is furnished in rolled strips, which must be secured to the ground with U-shaped staples or stakes in accordance with manufacturers' recommendations.

Coconut fiber blanket should be a machine produced mat of 100 percent coconut fiber with biodegradable netting on the top and bottom. The coconut fiber should be attached to the netting with biodegradable thread or glue strips. The coconut fiber blanket should be of consistent thickness. The coconut fiber should be evenly distributed over the entire area of the blanket.

Coconut fiber mesh is a thin permeable membrane made from coconut or corn fiber that is spun into a yarn and woven into a biodegradable mat. It is designed to be used in conjunction with vegetation and typically has longevity of several years. The material is supplied in rolled strips, which must be secured to the soil with U-shaped staples or stakes in accordance with manufacturers' recommendations.

Straw coconut fiber blanket should be machine produced mats of 70 percent straw and 30 percent coconut fiber with a biodegradable netting top layer and a biodegradable bottom net. The straw and coconut fiber should be attached to the netting with biodegradable thread or glue strips. The straw coconut fiber blanket should be of consistent thickness. The straw and coconut fiber should be evenly distributed over the entire area of the blanket. Straw coconut fiber blanket should be furnished in rolled strips a minimum of 6.5 ft wide, a minimum of 80 ft long and a minimum of 0.5 lb/yd². Straw coconut fiber blankets must be secured in place with wire staples. Staples should be made of minimum 11 gauge steel wire and should be U-shaped with 8 in. legs and 2 in. crown.

Non-biodegradable RECPs are typically composed of polypropylene, polyethylene, nylon or other synthetic fibers. In some cases, a combination of biodegradable and synthetic fibers is used to construct the RECP. Netting used to hold these fibers together is typically non-biodegradable as well.

Plastic netting is a lightweight biaxially oriented netting designed for securing loose mulches like straw or paper to soil surfaces to establish vegetation. The netting is photodegradable. The netting is supplied in rolled strips, which must be secured with U-shaped staples or stakes in accordance with manufacturers' recommendations.

Plastic mesh is an open weave geotextile that is composed of an extruded synthetic fiber woven into a mesh with an opening size of less than ¼ in. It is used with re-vegetation or may be used to secure loose fiber such as straw to the ground. The material is supplied in rolled strips, which must be secured to the soil with U-shaped staples or stakes in accordance with manufacturers' recommendations.

Synthetic fiber with netting is a mat that is composed of durable synthetic fibers treated to resist chemicals and ultraviolet light. The mat is a dense, three dimensional mesh of synthetic (typically polyolefin) fibers stitched between two polypropylene nets. The mats are designed to be re-vegetated and provide a permanent composite system of soil, roots, and geomatrix. The material is furnished in rolled strips, which must be secured with U-shaped staples or stakes in accordance with manufacturers' recommendations.

Bonded synthetic fibers consist of a three dimensional geomatrix nylon (or other synthetic) matting. Typically it has more than 90 percent open area, which facilitates root growth. It's tough root reinforcing system anchors vegetation and protects against hydraulic lift and shear forces created by high volume discharges. It can be installed over prepared soil, followed by seeding into the mat. Once vegetated, it becomes an invisible composite system of soil, roots, and geomatrix. The material is furnished in rolled strips that must be secured with U-shaped staples or stakes in accordance with manufacturers' recommendations.

Combination synthetic and biodegradable RECPs consist of biodegradable fibers, such as wood fiber or coconut fiber, with a heavy polypropylene net stitched to the top and a high strength continuous filament geomatrix or net stitched to the bottom. The material is designed to enhance re-vegetation. The material is furnished in rolled strips, which must be secured with U-shaped staples or stakes in accordance with manufacturers' recommendations.

Materials:

New types of blankets and matting materials are continuously being developed. The Texas Department of Transportation (TxDOT) has defined the critical performance factors for these types of products, and has established minimum performance standards which must be met for any product seeking to be approved for use within any of TxDOT's construction or maintenance activities. The products that have been approved by TxDOT are also appropriate for general construction site stabilization. TxDOT maintains a web site at:

<http://www.dot.state.tx.us/insdot/orgchart/cmd/erosion/contents.htm>

which is continually updated as new products are evaluated. The following tables list applications and products approved by TxDOT as of February 2001.

Table 3-5

CLASS 1 "SLOPE PROTECTION"

Type A - Slopes 3:1 or Flatter - Clay Soils:

Airtrol	Landlok BonTerra EcoNet™ ENCS2
Anti-wash/Geojute	Landlok BonTerra S1
BioD-Mesh 60	Landlok BonTerra S2
Carthage Mills Veg Net	Landlok BonTerra CS2
C-Jute	Landlok BonTerra SFB12
Contech Standard	Landlok 407GT
Contech Standard Plus	Landlok FRS 3112
Contech Straw/Coconut Fiber Mat w/Kraft N	Landlok TRM 435
Contech C-35	Miramat TM8
Conwed 3000	North American Green S150
Curlex I	North American Green S75
Curlex™-LT	North American Green® S75 BN
Earth Bound	North American Green SC150
EcoAegis™	North American Green® S150 BN
Econo-Jute	Maccaferri MX287
ECS Excelsior Blanket Standard	Pennzsuppress®
ECS High Velocity Straw Mat	Poplar Erosion Blanket
ECS Standard Straw	Soil Guard
EnviroGuard Plus	Soil Saver
Formula 480 Liquid Clay	SuperGro
Futerra®	Terra-Control®
Grass Mat	TerraJute
Greenfix WSO72	verdyol Ero-Mat
GeoTech TechMat™ SCKN	verdyol Excelsior High Velocity
Green Triangle Regular	verdyol Excelsior Standard
Green Triangle Superior	Webtec Terraguard 44P
Greenstreak Pec-Mat	Xcel Regular
Landlok BonTerra EcoNet™ ENS2	Xcel Superior

Table 3-6

Type B – Slopes 3:1 or Flatter - Sandy Soils:

C-Jute	Landlok® BonTerra®EcoNet™ENCS2™
Carthage Mills Veg Net	Landlok® BonTerra®EcoNet™ ENS2
Contech Standard	Landlok FRS 3112
Contech Standard Plus	Landlok 407GT
Contech Straw/Coconut Fiber Mat w/Kraft N	Landlok TRM 435
Contech C-35	Maccaferri MX287
Curlex LT	Miramat 1000
Earth Bound	Miramat TM8
ECS Standard Straw	North American Green S75
ECS Excelsior Blanket Standard	North American Green® S75 BN
ECS High Velocity Straw Mat	North American Green S150
EcoAegis™	North American Green SC150
EnviroGuard Plus	North American Green® S150 BN
Futerra®	Poplar Erosion Blanket
Greenfix WSO72	Soil Guard
Geojute Plus 1	Terra-Control®
GeoTech TechMat™ SCKN	TerraJute
Green Triangle Regular	verdyol Ero-Mat
Green Triangle Superior	verdyol Excelsior Standard
Landlok® BonTerra S1	Webtec Terraguard 44P
Landlok® BonTerra S2	Xcel Regular
Landlok® BonTerra CS2	Xcel Superior

Table 3-7

Type C - Slopes Steeper than 3:1 - Clay Soils:

Airtrol	Landlok® BonTerra S2
Anti-Wash/Geojute	Landlok BonTerra CS2
Carthage Mills Veg Net	Landlok® BonTerra SFB12
C-Jute	Landlok 407GT
Contech Standard Plus	Landlok FRS 3112
Contech Straw/Coconut Fiber Mat w/Kraft N	Landlok TRM 435
Contech C-35	Maccaferri MX287
Conwed 3000	Miramat TM8
Curlex I	North American Green S150
Earth Bound	North American Green S75
Econo Jute	North American Green SC150
ECS High Velocity Straw Mat	North American Green® S150 BN
ECS Standard Straw	Pennzsuppress®
EnviroGuard Plus	Poplar Erosion Blanket
Formula 480 Liquid Clay	Soil Guard
Futerra®	Soil Saver
Greenfix WSO72	SuperGro
Green Triangle Superior	TerraJute
GeoTech TechMat™ SCKN	Verdyol Excelsior High Velocity
Greenstreak Pec-Mat	Webtec Terraguard 44P
Landlok® BonTerra® EcoNet™ ENCS2	Xcel Superior

Table 3-8

Type D - Slopes Steeper than 3:1 - Sandy Soils:

C-Jute	Landlok® BonTerra CS2
Carghage Mills Veg Net	Landlok® BonTerra®EcoNet™ENCS2™
Contech Standard Plus	Landlok 407GT
Contech Straw/Coconut Fiber Mat w/Kraft N	Landlok FRS 3112
Contech C-35	Landlok TRM 435
Curlex I	Maccaferri MX287
ECS High Velocity Straw Mat	Miramat 1000
ECS Standard Straw	Miramat TM8
EnviroGuard Plus	North American Green S150
Futerra®	North American Green SC150
Greenfix WSO72	North American Green® S150 BN
Geojute Plus 1	Soil Guard
GeoTech TechMat™ SCKN	TerraJute
Green Triangle Superior	Webtec Terraguard 44P
Landlok® BonTerra S2	Xcel Superior

Table 3-9

CLASS 2 - "FLEXIBLE CHANNEL LINER"

Type E - Shear Stress Range 0 - 96 Pascal (0 - 2 Pounds Per Square Foot):

Contech TRM C-45	
Contech C-35	Koirmat™ 700
Contech C50	Landlok® BonTerra® C2
Contech Coconut/Poly Fiber Mat	Landlok® BonTerra® CP2
Contech Coconut Mat w/Kraft Net	Landlok® BonTerra® EcoNet™ ENC2
Curlex® II Stitched	Landlok® BonTerra® SFB™
Curlex® III Stitched	Landlok® BonTerra SFB12
Curlex® Channel Enforcer 1	Landlok TRM 435
Curlex® Channel Enforcer II	Landlok TRM 450
Earth-Lock	Landlok TRM 1050
Earth-Lock II	Landlok TRM 1060
ECS High Impact Excelsior	Maccaferri MX287
ECS Standard Excelsior	Miramat TM8
ECS High Velocity Straw Mat	Multimat 100
Enkamat 7018	North American Green C125 BN
Enkamat 7020	North American Green C350 Three Phase
Enkamat Composite 30	North American Green SC150 BN
Enkamat Composite NPK**	North American Green S350
Enviromat	North American Green® P350
Geotech TechMat™ CP 3-D	North American Green S150
Geotech TechMat™ CKN	Pyramat®
Greenfix CFO 72RP **	Webtec Terraguard 44P
Greenfix CFO 72RR	Webtec Terraguard 45P
Greenstreak Pec-Mat	Xcel PP-5

Table 3-10

Type F - Shear Stress Range 0 - 192 Pascal (0 - 4 Pounds Per Square Foot):

Curlex® II Stitched	Koirmat™ 700
Curlex® III Stitched	Landlok® BonTerra® C2
Curlex® Channel Enforcer 1	Landlok® BonTerra® CP2
Curlex® Channel Enforcer II	Landlok® BonTerra® EcoNet™ ENC2
Contech C50	Landlok BonTerra® SFB™
Contech TRM C-45	Landlok BonTerra SFB12
Contech C-35	Landlok TRM 435
Contech Coconut/Poly Fiber Mat	Landlok TRM 450
Contech Coconut Mat w/Kraft Net	Landlok TRM 1050
Earth-Lock	Landlok TRM 1060
Earth-Lock II	Maccaferri MX287
ECS High Impact Excelsior	Miramat TM8
ECS High Velocity Straw Mat	Multimat 100
ECS Standard Excelsior	North American Green C125 BN
Enkamat 7018	North American Green C350 Three Phase
Enkamat Composite 30	North American Green SC150 BN
Enkamat Composite NPK **	North American Green S350
Enkamat Composite P/T**	North American Green® P350
Enviromat	North American Green S150
Geotech TechMat™ CP 3-D	Pyramat®
Geotech TechMat™ CKN	Webtec Terraguard 44P
Greenfix CFO 72RP **	Webtec Terraguard 45P
Greenfix CFO 72RR	Xcel PP-5
Greenstreak Pec-Mat	

Table 3-11

Type G – Shear Stress Range 0 – 287 Pascal (0 – 6 Pounds Per Square Foot):

Contech TRM C-45	Koirmat™ 700
Contech C-35	Landlok® BonTerra® CP2
Contech C50	Landlok® BonTerra® SFB™
Contech Coconut/Poly Fiber Mat	Landlok® BonTerra SFB12
Curlex® III Stitched	Landlok TRM 1050
Curlex® Channel Enforcer II	Landlok TRM 1060
Earth-Lock	Landlok TRM 435
Earth-Lock II	Landlok TRM 450
Enkamat 7018	North American Green C350 Three Phase
Enkamat Composite 30	North American Green S350
Geotech TechMat™ CP 3-D	North American Green® P350
Greenstreak Pec-Mat	Pyramat®
	Webtec Terraguard 44P
	Webtec Terraguard 45P

Table 3-12

Type H - Shear Stress Range 0 - 383 Pascal (0 - 8 Pounds Per Square Foot):

Contech TRM C-45	Landlok TRM 1060
Contech C-35	North American Green C350 Three Phase
Contech C50	North American Green S350
Contech Coconut/Poly Fiber Mat	North American Green® P350
Curlex® III Stitched	Pyramat®
Geotech TechMat™ CP 3-D	Webtec Terraguard 44P
Landlok® BonTerra SFB12	Webtec Terraguard 45P
Landlok TRM 435	
Landlok TRM 450	
Landlok TRM 1050	

Table 3-13

SEEDING FOR EROSION CONTROL

Cellulose Fiber Mulches

Clay or Tight Soils:

Agri-Fiber
American Fiber Mulch
American Fiber Mulch (with Hydro-Stick)
Conwed Hydro Mulch
Enviro-Gro
Evercycle™ Hydro-Mulch
Excel Fibermulch II (with Exact-Tac)
Lay-Low Mulch
Oasis Fiber Mulch
Pennzsuppress®
Pro Mat
Pro Mat (with RMBplus)
Pro Mat XL
Second Nature Regenerated Paper Fiber Mulch
Silva Fiber Plus

Table 3-14

SEEDING FOR EROSION CONTROL

Sandy or Loose Soils:

American Fiber Mulch
American Fiber Mulch (with Hydro-Stick)
American Fiber Mulch with Stick Plus
Conwed Hydro Mulch
Enviro-Gro
Evercycle™ Hydro-Mulch
Excel Fibermulch II (with Exact-Tac)
Lay-Low Mulch
Oasis Fiber Mulch
Pennzsuppress®
Pro Mat
Pro Mat (with RMBplus)
Pro Mat XL
Second Nature Regenerated Paper Fiber Mulch

Installation:

Proper installation of blankets and matting is necessary for these materials to function as intended. They should always be installed in accordance with the manufacturer's recommendations. Proper anchoring of the material and preparation of the soil are two of the most important aspects of installation. Typical anchoring methods are shown in Figure 14 and Figure 15.

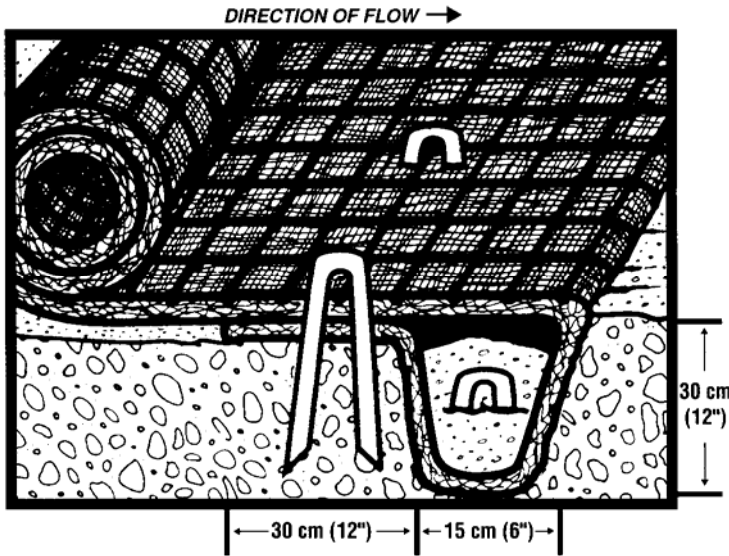

Figure 3-14 Initial Anchor Trench for Blankets and Mats

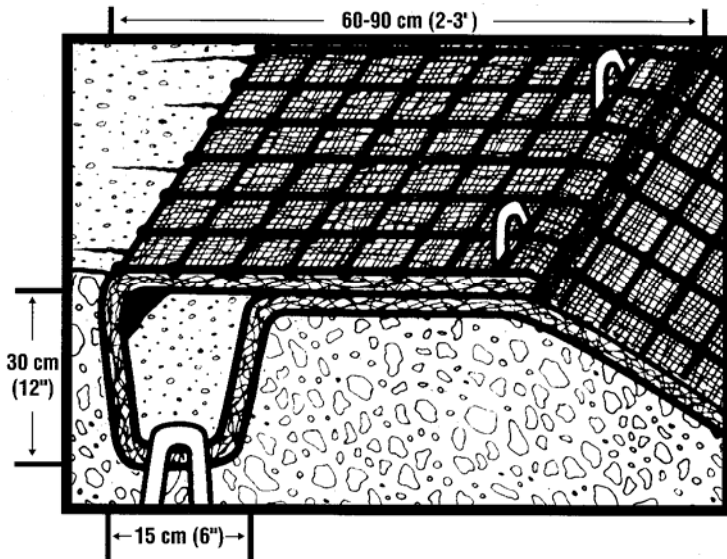

Figure 3-15 Terminal Anchor Trench for Blankets and Mats

Soil Preparation

- After site has been shaped and graded to approved design, prepare a friable seed bed relatively free from clods and rocks more than 1.5 inches in diameter and any foreign material that will prevent contact of the protective mat with the soil surface.
- Fertilize and seed in accordance with seeding or other type of planting plan.
- The protective matting can be laid over sprigged areas where small grass plants have been planted. Where ground covers are to be planted, lay the protective matting first and then plant through matting according to design of planting.

Erosion Stops

- Erosion stops should extend beyond the channel liner to full design cross-section of the channel to check any rills that might form outside the channel lining.
- The trench may be dug with a spade or a mechanical trencher, making sure that the down slope face of the trench is flat; it should be uniform and perpendicular to line of flow to permit proper placement and stapling of the matting.
- The erosion stop should be deep enough to penetrate solid material or below level of ruling in sandy soils. In general, erosion stops will vary from 6 to 12 inches in depth.
- The erosion stop mat should be wide enough to allow a minimum of 2 inch turnover at bottom of trench for stapling, while maintaining the top edge flush with channel surface.
- Tamp backfill firmly and to a uniform gradient of channel.

Final Check:

- Make sure matting is uniformly in contact with the soil.
- All lap joints are secure.
- All staples are flush with the ground.
- All disturbed areas seeded.

Inspection and Maintenance Guidelines:

- Blankets and matting should be inspected weekly and after each rain event to locate and repair any damage. Apply new material if necessary to restore function.

3.2.12 Organic Compost Mulch

Organic compost mulch consists of applying a mixture of shredded wood fiber, compost and a seed mixture with blowing equipment, which temporarily protects exposed soil from erosion by raindrop impact or wind. Organic compost mulch is suitable for soil disturbed areas requiring temporary protection until permanent stabilization is established, and disturbed areas that will be re-disturbed following an extended period of inactivity. It is not appropriate for use in creeks or waterways, but can be used on steep slopes (2:1). Compost products specified for use in this application are described in Table 3-15. The product's parameters will vary based on whether vegetation will be established on the treated slope.

Only compost products that meet all applicable state and federal regulations pertaining to its production and distribution may be used in this application. Approved compost products must meet related state and federal chemical contaminant (e.g., heavy metals, pesticides, etc.) and pathogen limit standards pertaining to the feedstocks (source materials) in which it is derived.

Materials:

- Very coarse compost should be avoided if the slope is to be landscaped or seeded as it will make planting and crop establishment more difficult.
- In regions subject to higher rates of precipitation and/or rainfall intensity, higher compost application rates should be used. In these particular regions, as well as regions subject to wind erosion, coarser compost products are preferred.

Notes: Specifying the use of compost products that are certified by the US Composting Council's Seal of Testing (STA) Program (www.compostingcouncil.org) will allow for the acquisition of products that are analyzed on a routine basis, using the specified test methods. STA participants are also required to provide a standard product label to all customers, allowing easy comparison to other products.

Table 3-15 Compost Blanket Parameters

Parameters ^{1,4}	Reported as (units of measure)	Surface Mulch to be Vegetated	Surface Mulch to be left Un-vegetated
pH ²	pH units	5.0 - 8.5	N/A
Soluble Salt Concentration ² (electrical conductivity)	dS/m (mmhos/cm)	Maximum 5	Maximum 5
Moisture Content	%, wet weight basis	30 – 60	30 – 60
Organic Matter Content	%, dry weight basis	25 – 65	25-100
Particle Size	% passing a selected mesh size	<ul style="list-style-type: none"> • 3" (75 mm), 100% passing • 1" (25mm), 90% to 100% p • 3/4" (19mm), 65% to 100% p • 1/4" (6.4 mm), 0% to 75% pa • Maximum particle length of 	<ul style="list-style-type: none"> • 3" (75 mm), 100% passing • 1" (25mm), 90% to 100% p • 3/4" (19mm), 65% to 100% p • 1/4" (6.4 mm), 0% to 75% pa • Maximum particle length of
Stability ³ Carbon Dioxide Evolution Rate	mg CO ₂ -C per g OM per day	< 8	N/A
Physical Contaminants (man-n	%, dry weight basis	< 1	< 1

¹ Recommended test methodologies are provided in Test Methods for the Examination of Composting and Compost (TMECC, The US Composting Council)

² Each specific plant species requires a specific pH range. Each plant also has a salinity tolerance rating, and maximum tolerable quantities are known. When specifying the establishment of any plant or turf species, it is important to understand their pH and soluble salt requirements, and how they relate to the compost in use.

³ Stability/Maturity rating is an area of compost science that is still evolving, and as such, other various test methods could be considered. Also, never base compost quality conclusions on the result of a single stability/maturity test.

⁴ Landscape architects and project (field) engineers may modify the allowable compost specification ranges based on specific field conditions and plant requirements.

Installation:

- The following steps shall be taken for the proper installation of compost as a soil blanket for erosion/sediment control on sloped areas.
- Slightly roughen (scarify) slopes and remove large clods, rocks, stumps, roots larger than 2 inches in diameter and debris on slopes where vegetation is to be established. This soil preparation step may be eliminated where approved by the Project Engineer or Landscape Architect/Designer, or where seeding or planting is not planned. Where practical, track (compact) perpendicular to contours on the slope using a bulldozer before applying compost as soil blanket.
- Apply compost at the rates specified in Table 3-16.

Table 3-16 Compost Blanket Application Rates

Annual Rainfall/ Flow Rate	Total Precipitation & Rainfall Erosivity Index	Application Rate For Vegetated* Compost Surface Mulch	Application Rate For Unvegetated Compost Surface Mulch
Low	1-25", 20-90	1/2 - 3/4" (12.5 mm - 19 mm)	1" - 1 1/2" (25 mm - 37.5mm)
Average	26-50", 91-200	3/4 - 1" (19 mm - 25 mm)	1 1/2" - 2" (37 mm - 50 mm)
High	51" and above, 201 and above	1-2" (25 mm - 50 mm)	2-4" (50mm - 100mm)

*these lower application rates should only be used in conjunction with seeding, and for compost blankets applied during the prescribed planting season for the particular region.

Compost blanket application rates should be modified based on specific site (e.g., soil characteristics, existing vegetation) and climatic conditions, as well as particular project related requirements. The severity of slope grade, as well as slope length, will also influence compost application rates.

In regions subjected to higher rates of precipitation and/or rainfall intensity, higher compost application rates should be used. In these regions, as well as those with spring snow melt, and on sites possessing severe grades or long slope lengths, the compost blanket may be used in conjunction with a compost filter berm. The filter berm may be 1-2 feet high (30 cm – 60 cm), by 2-4 feet wide (60 cm – 120 cm), and may be placed at the top or base (or both) of the slope. In these particular regions, as well as regions subject to wind erosion, coarser compost products are also preferred.

In regions subject to lower rates of precipitation and/or rainfall intensity, lower compost application rates may be used.

Note: Specific regions may receive higher rainfall rates, but this rainfall is received through low intensity rainfall events (e.g., the Northwestern U.S.). These regions may use lower compost application rates.

Compost shall be uniformly applied using a pneumatic (blower) unit, or other unit that propels the product directly at the soil surface, thereby preventing water from moving between the soil-compost interface. Thorough watering may be used to improve settling of the compost. Apply compost layer approximately 3 feet (90 cm) over the top of the slope, or overlap it into existing vegetation.

On highly unstable soils, use compost in conjunction with appropriate structural measures.

Dry or hydraulic seeding may be completed following compost application, as required, or during the compost application itself, where a pneumatic unit is used to apply the compost.

Inspection and Maintenance Guidelines:

- Mulched areas should be inspected weekly and after each rain event to locate and repair any damage.

3.2.13 Hydraulic Mulch

Hydraulic mulch consists of applying a mixture of shredded wood fiber or a hydraulic matrix, and a stabilizing emulsion or tackifier with hydro-mulching equipment, which temporarily protects exposed soil from erosion by raindrop impact or wind. Hydraulic mulch is suitable for soil disturbed areas requiring temporary protection until permanent stabilization is established, and disturbed areas that will be re-disturbed following an extended period of inactivity. Seed may be added to the mulch for temporary or permanent vegetation. It is not appropriate for slopes steeper than 3H:1V or for use in channels.

Wood fiber hydraulic mulches are generally short lived and need 24 hours to dry before rainfall occurs to be effective. A second application may be necessary in order to remain effective for an entire rainy season.

Materials:

- *Hydraulic Mulches:* Wood fiber mulch can be applied alone or as a component of hydraulic matrices. Wood fiber applied alone is typically applied at the rate of 2,000 to 4,000 lb/acre. Wood fiber mulch is manufactured from wood or wood waste from lumber mills or from urban sources.
- *Hydraulic Matrices:* Hydraulic matrices include a mixture of wood fiber and acrylic polymer or other tackifier as binder. Apply as a liquid slurry using a hydraulic application machine (i.e., hydro seeder) at the following minimum rates, or as specified by the manufacturer to achieve complete coverage of the target area: 2,000 to 4,000 lb/acre wood fiber mulch, and 5 to 10% (by weight) of tackifier (acrylic copolymer, guar, psyllium, etc.)
- *Bonded Fiber Matrix:* Bonded fiber matrix (BFM) is a hydraulically applied system of fibers and adhesives that upon drying forms an erosion resistant blanket that promotes vegetation, and prevents soil erosion. BFMs are typically applied at rates from 3,000 lb/acre to 4,000 lb/acre based on the manufacturer's recommendation. A biodegradable BFM is composed of materials that are 100% biodegradable. The binder in the BFM should also be biodegradable and should not dissolve or disperse upon re-wetting. Typically, biodegradable BFMs should not be applied immediately before, during or immediately after rainfall if the soil is saturated. Depending on the product, BFMs typically require 12 to 24 hours to dry and become effective.

Installation:

- Prior to application, roughen embankment and fill areas by rolling with a crimping or punching type roller or by track walking. Track walking shall only be used where other methods are impractical.
- To be effective, hydraulic matrices require 24 hours to dry before rainfall occurs.
- Avoid mulch over spray onto roads, sidewalks, drainage channels, existing vegetation, etc.

Inspection and Maintenance Guidelines:

- Mulched areas should be inspected weekly and after each rain event to locate and repair any damage.
- Areas damaged by storms or normal construction activities should be regraded and hydraulic mulch reapplied as soon as practical.

3.2.14 Sod

Sod is appropriate for disturbed areas which require immediate vegetative covers, or where sodding is preferred to other means of grass establishment. Locations particularly suited to stabilization with sod are waterways carrying intermittent flow, areas around drop inlets or in grassed swales, and residential or commercial lawns where quick use or aesthetics are factors.

The advantages of properly installed sod include:

- Immediate erosion control.
- An instant green surface with no dust or mud.
- Nearly year-round establishment capability.
- Less chance of failure than seed.
- Freedom from weeds.
- Quick use of the sodded surface.
- The option of buying a quality-controlled product with predictable results.

It is initially more costly to install sod than to seed. However, this cost is justified in places where sod can perform better than seed in controlling erosion. In swales and waterways where concentrated flow will occur, properly pegged sod is preferable to seed because there is no lag time between installation and the time when the channel is protected by vegetation. Drop inlets, which will be placed in grassed areas, can be kept

free of sediment, and the grade immediately around the inlet can be maintained, by framing the inlet with sod strips.

Sod can be laid during times of the year when seeded grass may fail, so long as there is adequate water available for irrigation in the early weeks. Ground preparation and proper maintenance are as important with sod as with seed. Sod is composed of living plants and those plants must receive adequate care in order to provide vegetative stabilization on a disturbed area.

Materials:

- Sod should be machine cut at a uniform soil thickness of $\frac{3}{4}$ inch ($\pm \frac{1}{4}$ inch) at the time of cutting. This thickness should exclude shoot growth and thatch.
- Pieces of sod should be cut to the supplier's standard width and length, with a maximum allowable deviation in any dimension of 5%. Torn or uneven pads should not be acceptable.
- Standard size sections of sod should be strong enough to support their own weight and retain their size and shape when suspended from a firm grasp on one end of the section.
- Sod should be harvested, delivered, and installed within a period of 36 hours.

Site Preparation:

- Prior to soil preparation, areas to be sodded should be brought to final grade in accordance with the approved plan.
- The surface should be cleared of all trash, debris and of all roots, brush, wire, grade stakes and other objects that would interfere with planting, fertilizing or maintenance operations.
- Fertilize according to soil tests. Fertilizer needs can be determined by a soil testing laboratory or regional recommendations can be made by county agricultural extension agents. Fertilizer should be worked into the soil to a depth of 3 inches with a disc, springtooth harrow or other suitable equipment. On sloping land, the final harrowing or discing operation should be on the contour.

General Installation:

- Sod should not be cut or laid in excessively wet or dry weather. Sod also should not be laid on soil surfaces that are frozen.

- During periods of high temperature, the soil should be lightly irrigated immediately prior to laying the sod, to cool the soil and reduce root burning and dieback.
- The first row of sod should be laid in a straight line with subsequent rows placed parallel to and butting tightly against each other. Lateral joints should be staggered to promote more uniform growth and strength. Care should be exercised to ensure that sod is not stretched or overlapped and that all joints are butted tight in order to prevent voids which would cause drying of the roots (see Figure 3-16).
- On slopes sod should be laid with staggered joints and secured by stapling or other approved methods. On slopes 3:1 or greater, or wherever excessive erosion may be a problem, Sod should not be used.
- As sodding of clearly defined areas is completed, sod should be rolled or tamped to provide firm contact between roots and soil.
- After rolling, sod should be irrigated to a depth sufficient that the underside of the sod pad and the soil 4 inches below the sod is thoroughly wet.
- Until such time a good root system becomes developed, in the absence of adequate rainfall, watering should be performed as often as necessary to maintain moist soil to a depth of at least 4 inches.
- The first mowing should not be attempted until the sod is firmly rooted, usually 2-3 weeks. Not more than one third of the grass leaf should be removed at any one cutting.

Installation in Channels:

- Sod strips in waterways should be laid perpendicular to the direction of flow. Care should be taken to butt ends of strips tightly (see Figure 3-17).
- After rolling or tamping, sod should be pegged or stapled to resist washout during the establishment period. Mesh or other netting may be pegged over the sod for extra protection in critical areas.



LAY SOD IN A STAGGERED PATTERN. BUTT THE STRIPS TIGHTLY AGAINST EACH OTHER. DO NOT LEAVE SPACES AND DO NOT OVERLAP. A SHARPENED MASON'S TROWEL IS A HANDY TOOL FOR TUCKING DOWN THE ENDS AND TRIMMING PIECES.

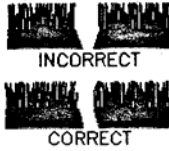

BUTTING - ANGLED ENDS CAUSED BY THE AUTO-MATIC SOD CUTTER MUST BE MATCHED CORRECTLY.



ROLL SOD IMMEDIATELY TO ACHIEVE FIRM CONTACT WITH THE SOIL.

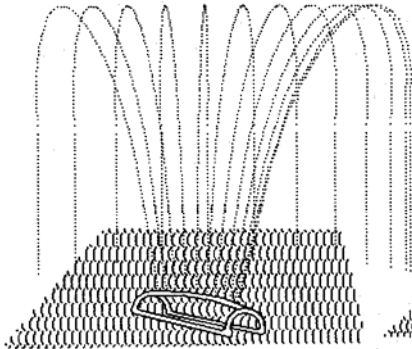

WATER TO A DEPTH OF 4" AS NEEDED. WATER WELL AS SOON AS THE SOD IS LAID.

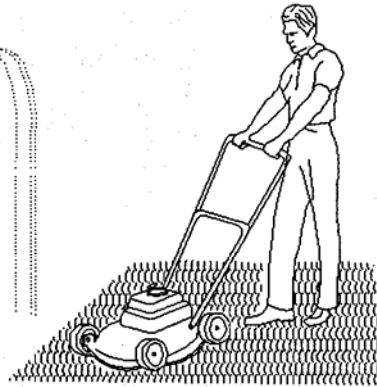

MOW WHEN THE SOD IS ESTABLISHED - IN 2-3 WEEKS. SET THE MOWER HIGH (2"-3").

APPEARANCE OF GOOD SOD

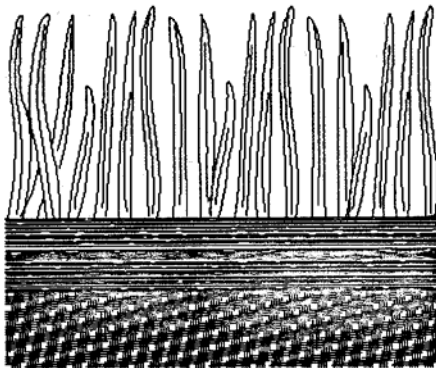

SHOOTS OR GRASS BLADES. GRASS SHOULD BE GREEN AND HEALTHY, MOWED AT A 2"-3" CUTTING HEIGHT.

THATCH - GRASS CLIPPINGS AND DEAD LEAVES, UP TO 1/2" THICK.

ROOT ZONE - SOIL AND ROOTS. SHOULD BE 1/2"-3/4" THICK, WITH DENSE ROOT MAT FOR STRENGTH.

Figure 3-16 Proper Sod Installation Techniques

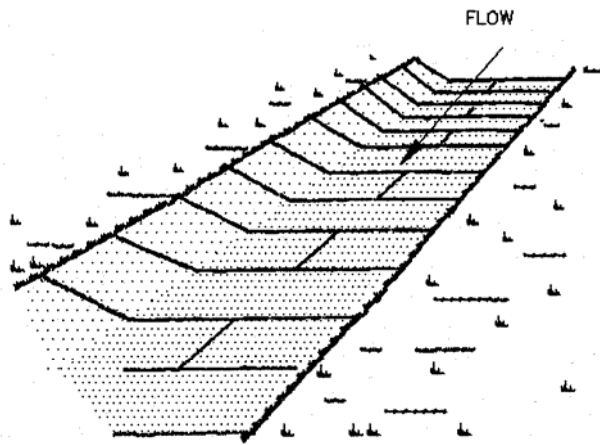

LAY SOD ACROSS THE DIRECTION OF FLOW.

USE PEGS OR STAPLES TO FASTEN SOD FIRMLY - AT THE ENDS OF STRIPS AND IN THE CENTER, OR EVERY 3-4 FEET IF THE STRIPS ARE LONG. WHEN READY TO MOW, DRIVE PEGS OR STAPLES FLUSH WITH THE GROUND.

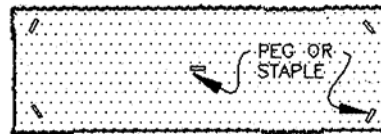
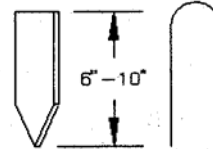

IN CRITICAL AREAS, SECURE SOD WITH NETTING. USE STAPLES.

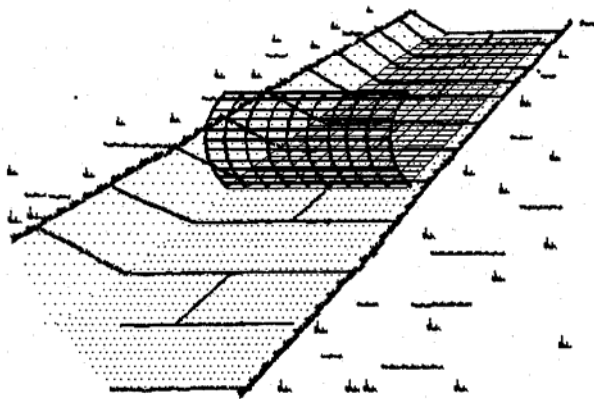

Figure 3-17 Installation of Sod in a Channel

Inspection and Maintenance Guidelines:

- Sod should be inspected weekly and after each rain event to locate and repair any damage.
- Damage from storms or normal construction activities such as tire ruts or disturbance of swale stabilization should be repaired as soon as practical.

3.2.15 Dust Control

The purpose of dust control is to prevent blowing and movement of dust from exposed soil surfaces, reduce on and off-site damage, health hazards and improve traffic safety. This practice is applicable to areas subject to dust blowing and movement where on and off-site damage is likely without treatment.

Construction activities inevitably result in the exposure and disturbance of soil. Fugitive dust is emitted both during the activities (i.e., excavation demolition, vehicle traffic, human activity) and as a result of wind erosion over the exposed earth surfaces. Large quantities of dust are typically generated in ‘heavy’ construction activities, such as road and street construction and subdivision, commercial or industrial development, which involve disturbance of significant areas of the soil surface. Research on construction sites has established an average dust emission rate of 1.2 tons/acre/month for active construction. Earth moving activities comprise the major source of construction dust emissions, but traffic and general disturbance of the soil also generate significant dust emissions.

Temporary Methods:

- Vegetative Cover - See Section 3.2.11.
- Mulches - See Section 3.2.12– Chemical mulch binders may be used to bind mulch material. Commercial binders should be used according to manufacturer’s recommendations.
- Commercially available dust suppressors if applied in accordance with the manufacturers’ directions
- Tillage - to roughen surface and bring clods to the surface. This is an emergency measure that should be used before soil blowing starts. Begin plowing on windward side of site. Chisel-type plows spaced about 12 inches apart, spring-toothed harrows and similar plows are examples of equipment that may produce the desired effect. -
- Irrigation - Site is sprinkled with water until the surface is moist. Repeat as needed. Irrigation can be particularly effective for controlling dust during trenching operations. A dedicated water truck placed next to the trencher and using a “pulse” fog pattern applied to the discharge belt can effectively control dust. This method is more effective than spraying the ground ahead of the trencher or the trench itself as it is being dug.
- Barriers - Solid board fences, snow fences, burlap fences, crate walls, bales of hay and similar materials can be used to control air currents and soil blowing. Barriers placed at right angles to prevailing currents at intervals of about 15 times their height are effective in controlling soil blowing.

Permanent Methods:

- Permanent Vegetation -- trees or large shrubs may afford valuable protection if left in place.
- Topsoil - Covering with less erosive soil material.
- Stone - Cover surface with crushed stone or coarse gravel.

Inspection and Maintenance Guidelines:

- When dust is evident during dry weather, reapply dust control BMPs.

3.3 *Sediment Control BMPs*

3.3.1 General Guidelines

Construction activities normally result in disturbance on the site due to grading operations, clearing and other activities. Erosion will occur in the disturbed areas and BMPs should be used to contain the sediment transported by stormwater runoff. Although the names of many controls suggest that filtration is an important component of sediment removal, almost all reduction in sediment load is the result of particle settling under relatively quiescent conditions. Consequently, sediment barriers, such as silt fences and rock berms, should be designed and installed as temporary (although leaky) dams.

When viewed as temporary dams, it is easier to see the importance of installing these devices along the contour or with a constant top elevation to prevent concentrating the runoff at the lowest spot in the barrier. Concentrating the runoff in this fashion can result in more erosion than if no barrier was installed at all. Therefore, great care should be taken in the placement and installation of these types of controls.

For larger areas or where effective installation of sediment barriers is not an option, sediment traps and sediment basins should be used to control sediment in runoff. These devices are essentially larger, more permanent dams that temporarily detain stormwater runoff.

All of the sediment control BMPs are potentially very effective for removing sediment from stormwater runoff when properly maintained and installed. However, this potential is often squandered. Casual observation of many active construction sites reveals silt fences that are torn or damaged by equipment, evidence of stormwater bypass, or controls installed in inappropriate locations (i.e., silt fences used in channels). In these cases, significant funds are expended for little in the way of water quality protection.

Consequently, proper installation and maintenance should form a key component of any temporary sediment control plan.

A list of the temporary sediment controls and their appropriate siting criteria are contained in Table 3-17. More detailed guidance on siting and maintenance are contained in the subsequent sections. Note that hay bales are no longer considered an effective sediment control measure. Compost amended soils can be used to promote vegetation growth, but they are not considered a sediment control technology..

Table 3-17 Guidelines for Selection of Sediment Control BMPs

Control Type	Applications	Drainage Area	Slope	Spacing
Construction Exit	Should be used at all designated access points.	NA	NA	NA
Silt Fence (interior)	Areas of minor sheet flow.	2 acres	< 20%	200 ft
Silt Fence (exterior)	Down slope borders of site; up slope border is necessary to divert offsite drainage. For larger areas use diversion swale or berm.	NA	See Table 3-18	See Table 3-18
Triangular Filter Dike	Areas within site requiring frequent access.	< 1 acre	< 10%	NA
Rock Berm	Drainage swales and ditches with and below site.	< 5 acres	< 30%	See Table 3-19
High Service Rock Berm	Around sensitive features, high flow areas within and below site.	< 5 acres	< 30%	See Table 3-19
Brush Berm	Small areas of sheet flow	< 2 acres	< 20%	See Table 3-19
Vegetative Buffer Strips	On floodplains, next to wetlands, along stream banks, and on steep slopes.	NA	NA	NA
Inlet Protection	Prevent sediment from entering storm drain system.	< 1 acre	NA	NA
Sediment Trap	Used where flows concentrated in a swale or channel	1-5 acres	NA	NA
Sediment Basin	Appropriate for large disturbed areas	5 – 100 acres	NA	NA
Filter Rolls	On slopes to interrupt slope	< 1 acre	<30%	See Table 3-19
Dewatering Operations	Used to remove groundwater or accumulated stormwater from excavations	NA	NA	NA
Spill Prevention	Used on all sites to reduce spills	NA	NA	NA
Creek Crossings	Crossings of drainage ways and creeks	>5 acres	NA	See Detail
Concrete Washout	Use on all concrete pouring operations	NA	NA	NA

Table 3-18
Silt Fence Spacing on Sloping Sites

Slope angle	Soil Type		
	Silty	Clays	Sandy
Very steep (1:1)	50 ft.	75 ft.	100 ft.
Steep (2:1)	75 ft.	100 ft.	125 ft.
Moderate (4:1)	100 ft.	125 ft.	150 ft.
Slight (10:1)	125 ft.	150 ft.	200 ft.

Table 3-19
Rock Berm Spacing on Channels
(for rock berms, high service rock berms, brush berms, and fiber rolls)

Ditch slope	Spacing
30%	10 ft.
20%	15 ft.
15%	20 ft.
10%	35 ft.
5%	55 ft.
3%	100 ft.
2%	150 ft.
1%	300 ft.
0.50%	600 ft.

3.3.2 Temporary Construction Entrance/Exit

The purpose of a temporary construction entrance is to provide a stable entrance/exit condition from the construction site and keep mud and sediment off public roads. A stabilized construction entrance is a stabilized pad of crushed stone located at any point traffic will be entering or leaving the construction site from a public right-of-way, street, alley, sidewalk or parking area. The purpose of a stabilized construction entrance is to reduce or eliminate the tracking or flowing of sediment onto public rights-of-way. This practice should be used at all points of construction ingress and egress. Schematic diagrams of a construction entrance/exit are shown in Figure 3-18 and Figure 3-19.

Excessive amounts of mud can also present a safety hazard to roadway users. To minimize the amount of sediment loss to nearby roads, access to the construction site should be limited to as few points as possible and vegetation around the perimeter should be protected where access is not necessary. A rock stabilized construction entrance should be used at all designated access points.

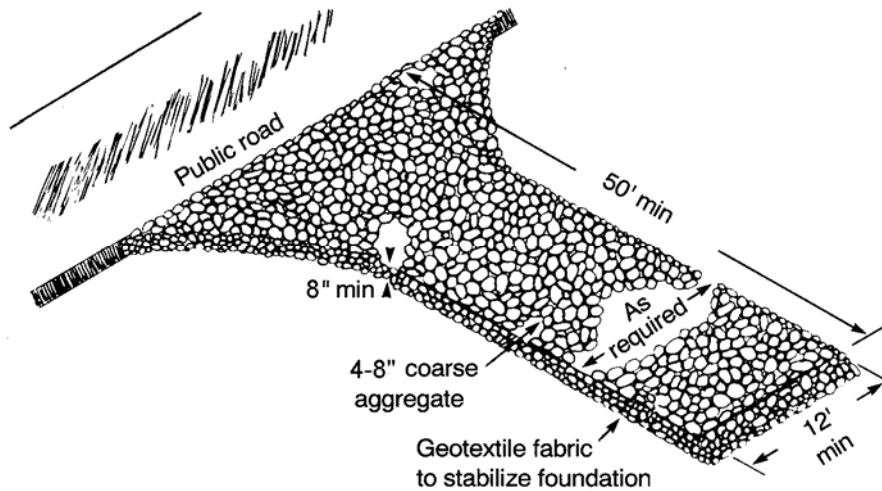

Figure 3-18 Schematic of Temporary Construction Entrance/Exit

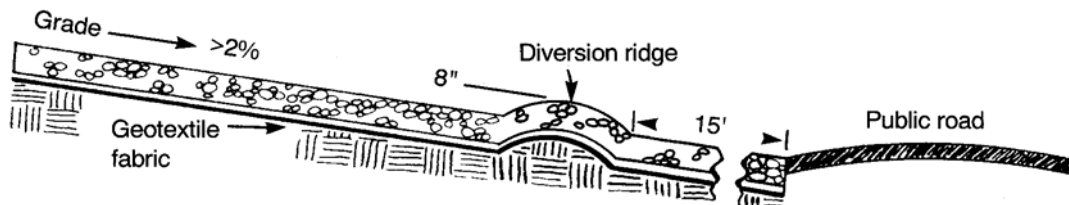

Figure 3-19 Cross-section of a Construction Entrance/Exit

Materials:

- The aggregate should consist of 4 to 8 inch washed stone over a stable foundation as specified in the plan.
- The aggregate should be placed with a minimum thickness of 8 inches.
- The geotextile fabric should be designed specifically for use as a soil filtration media with an approximate weight of 4 oz/yd².
- If a washing facility is required, a level area with a minimum of 4 inch diameter washed stone or commercial rack should be included in the plans. Divert wastewater to a sediment trap or basin.

Installation:

- Avoid curves on public roads and steep slopes. Remove vegetation and other objectionable material from the foundation area. Grade crown foundation for positive drainage.
- The minimum width of the entrance/exit should be 12 feet or the full width of exit roadway, whichever is greater.
- The construction entrance should be at least 50 feet long.
- If the slope toward the road exceeds 2%, construct a ridge, 6 to 8 inches high with 3:1 (H:V) side slopes, across the foundation approximately 15 feet from the entrance to divert runoff away from the public road.
- Place geotextile fabric and grade foundation to improve stability, especially where wet conditions are anticipated.
- Place stone to dimensions and grade shown on plans. Leave surface smooth and slope for drainage.
- Divert all surface runoff and drainage from the stone pad to a sediment trap or basin if necessary.
- Install pipe under pad as needed to maintain proper public road drainage.

Common trouble points

- Inadequate runoff control – sediment washes onto public road.
- Stone too small or geotextile fabric absent, results in muddy condition as stone is pressed into soil.
- Pad too short for heavy construction traffic – extend pad beyond the minimum 50 foot length as necessary.
- Pad not flared sufficiently at road surface, results in mud being tracked on to road and possible damage to road edge.
- Unstable foundation – use geotextile fabric under pad and/or improve foundation drainage.

Inspection and Maintenance Guidelines:

- The entrance should be maintained in a condition, which will prevent tracking or flowing of sediment onto public rights-of-way. This may require periodic top dressing with additional stone as conditions demand and repair and/or cleanout of any measures used to trap sediment.
- All sediment spilled, dropped, washed or tracked onto public rights-of-way should be removed immediately by contractor.
- When necessary, wheels should be cleaned to remove sediment prior to entrance onto public right-of-way.
- When washing is required, it should be done on an area stabilized with crushed stone that drains into an approved sediment trap or sediment basin.
- All sediment should be prevented from entering any storm drain, ditch or water course by using approved methods.

3.3.3 Silt Fence

A silt fence is a barrier consisting of geotextile fabric supported by metal posts to prevent soil and sediment loss from a site. When properly used, silt fences can be highly effective at controlling sediment from disturbed areas. They cause runoff to pond, allowing heavier solids to settle out. If not properly installed, silt fences are not likely to be effective. A schematic illustration of a silt fence is shown in Figure 3-20.

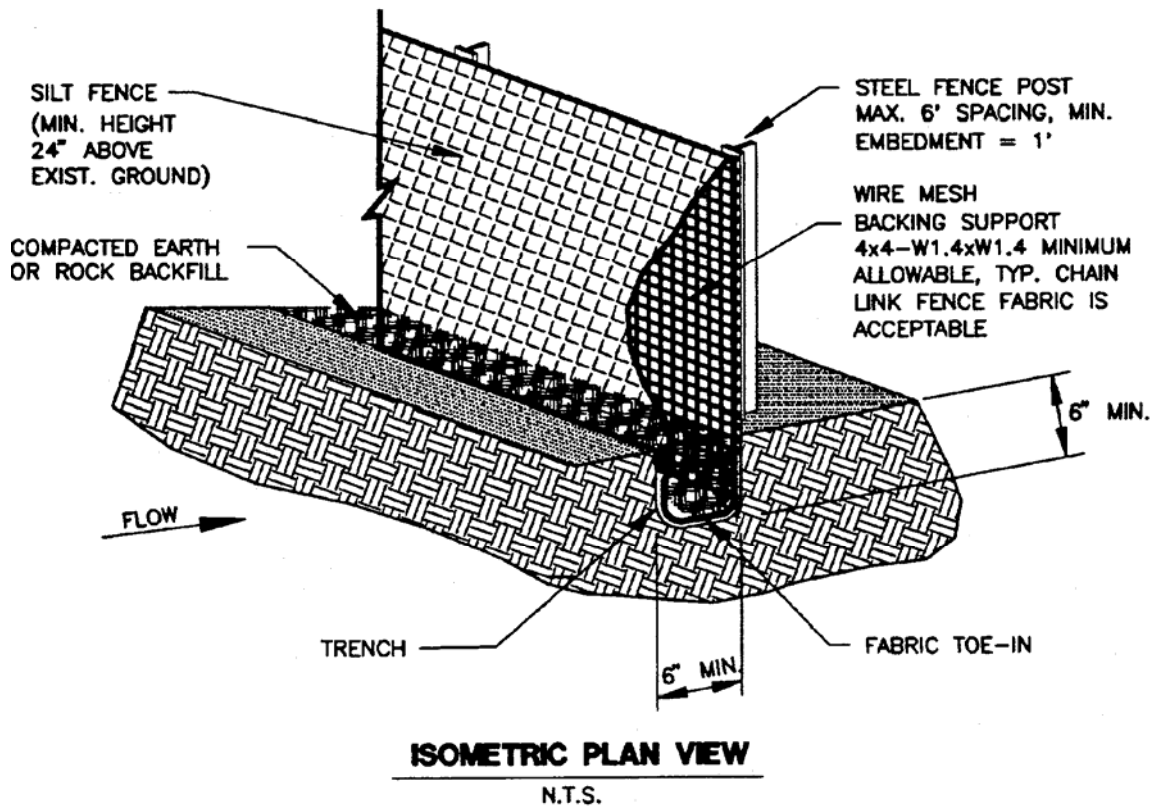

Figure 3-20 Schematic of a Silt Fence Installation

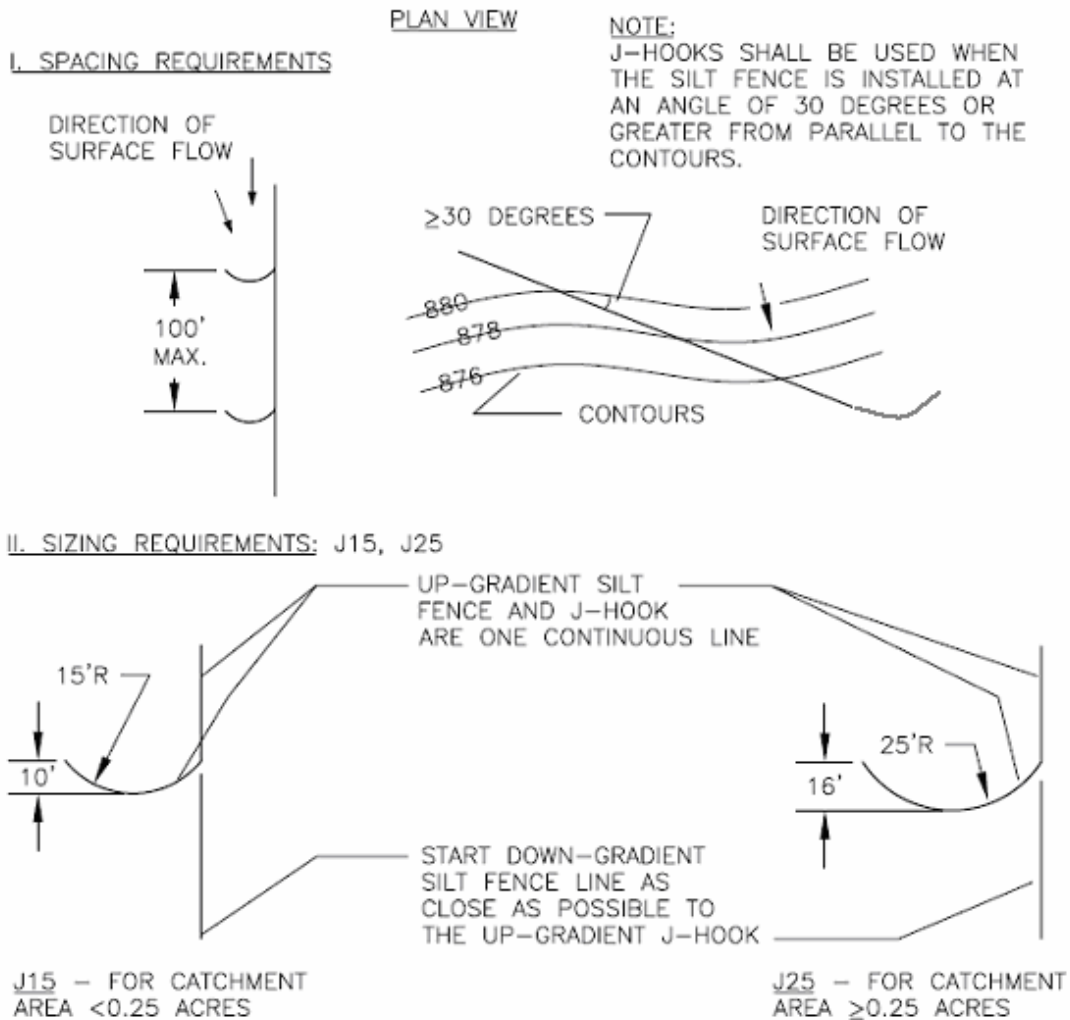

Figure 3-21 J-hook Placement Details

The purpose of a silt fence is to intercept and detain water-borne sediment from unprotected areas of a limited extent. Silt fence is used during the period of construction near the perimeter of a disturbed area to intercept sediment while allowing water to percolate through. This fence should remain in place until the disturbed area is permanently stabilized. Silt fence should not be used where there is a concentration of water in a channel or drainage way. If concentrated flow occurs after installation, corrective action must be taken such as placing a rock berm in the areas of concentrated flow.

Silt fencing within the site may be temporarily moved during the day to allow construction activity provided it is replaced and properly anchored to the ground at the end of the day. Silt fences on the perimeter of the site or around drainage ways should not be moved at any time.

Use J-hooks to trap and pond runoff flowing along uphill side of silt fence as shown in Figure 3-21. This will filter or settle outflows and prevent runoff from escaping around the sides of the fence.

Materials:

- Silt fence material should be polypropylene, polyethylene or polyamide woven or nonwoven fabric. The fabric width should be 36 inches, with a minimum unit weight of 4 oz/yd, ultraviolet stability exceeding 70%, and minimum apparent opening size of U.S. Sieve No. 30.
- Fence posts should be made of hot rolled steel, at least 4 feet long with Tee or Y-bar cross section, surface painted or galvanized, minimum nominal weight 1.25 lb/ft², and Brindell hardness exceeding 140.
- Woven wire backing to support the fabric should be galvanized 2" x 4" welded wire, 12 gauge minimum.

Installation:

- Steel posts, which support the silt fence, should be installed on a slight angle toward the anticipated runoff source. Post must be embedded a minimum of 1-foot deep and spaced not more than 8 feet on center. Where water concentrates, the maximum spacing should be 6 feet.
- Lay out fencing down-slope of disturbed area, following the contour as closely as possible. Utilize J-hooks as necessary as shown in Figure 3-21 . The fence should be sited so that the maximum drainage area is ¼ acre/100 feet of fence.
- The toe of the silt fence should be trenched in with a spade or mechanical trencher, so that the down-slope face of the trench is flat and perpendicular to the line of flow. Where fence cannot be trenched in (e.g., pavement or rock outcrop), weight fabric flap with 3 inches of pea gravel on uphill side to prevent flow from seeping under fence.
- The trench must be a minimum of 6 inches deep and 6 inches wide to allow for the silt fence fabric to be laid in the ground and backfilled with compacted material.
- Silt fence should be securely fastened to each steel support post or to woven wire, which is in turn attached to the steel fence post. There should be a 3-foot overlap, securely fastened where ends of fabric meet.

- Silt fence should be removed when the site is completely stabilized so as not to block or impede storm flow or drainage.

Common Trouble Points:

- Fence not installed along the contour causing water to concentrate and flow over the fence.
- Fabric not seated securely to ground (runoff passing under fence)
- Fence not installed perpendicular to flow line (runoff escaping around sides)
- Fence treating too large an area, or excessive channel flow (runoff overtops or collapses fence)

Inspection and Maintenance Guidelines:

- Inspect all fencing weekly, and after any rainfall in excess of 0.5 inch or more.
- Remove sediment when buildup reaches 6 inches.
- Replace any torn fabric.
- Replace or repair any sections crushed or collapsed in the course of construction activity. If a section of fence is obstructing vehicular access, consider relocating it to a spot where it will provide equal protection, but will not obstruct vehicles. A triangular filter dike may be preferable to a silt fence at common vehicle access points.
- When construction is complete, the sediment should be disposed of in a manner that will not cause additional siltation and the prior location of the silt fence should be revegetated. The fence itself should be disposed of in an approved landfill.

3.3.4 Triangular Sediment Filter Dikes

The purpose of a triangular sediment filter dike (Figure 3-22) is to intercept and detain water-borne sediment from unprotected areas of limited extent. The triangular sediment filter dike is used where there is no concentration of water in a channel or other drainage way above the barrier and the contributing drainage area is less than one acre. If the uphill slope above the dike exceeds 10%, the length of the slope above the dike should be less than 50 feet. If concentrated flow occurs after installation, corrective action should be taken such as placing rock berm in the areas of concentrated flow.

This measure is effective on paved areas where installation of silt fence is not possible or where vehicle access must be maintained. The advantage of these controls is the ease with which they can be moved to allow vehicle traffic, then reinstalled to maintain sediment control.

Materials:

- Silt fence material should be nonwoven fabric. The fabric width should be 36 inches, with a minimum unit weight of 4.0 oz/yd.
- The dike structure should be 6 gauge 6" x 6" wire mesh folded into triangular form being eighteen (18) inches on each side.
- The sand bag material should be polypropylene, polyethylene, polyamide or cotton burlap woven fabric, minimum unit weight 4 oz/yd², mullen burst strength exceeding 300 psi and ultraviolet stability exceeding 70 percent.
- The bag length should be 24 to 30 inches, width should be 16 to 18 inches and thickness should be 6 to 8 inches.
- Sandbags should be filled with coarse grade sand, free from deleterious material. All sand should pass through a No. 10 sieve. The filled bag should have an approximate weight of 40 pounds and stapled or tied with nylon or poly cord.

Installation:

- As shown in the diagram (Figure 3-22), the frame should be constructed of 6" x 6", 6 gauge welded wire mesh, 18 inches per side, and wrapped with geotextile fabric the same composition as that used for silt fences.
- Filter fabric should lap over ends six (6) inches to cover dike to dike junction; each junction should be secured by shoat rings.
- Position dike parallel to the contours, with the end of each section closely abutting the adjacent sections.
- Sandbags should be placed every three (3) feet to fasten the filter dike to the ground as shown in Figure 3-22.
- When moved to allow vehicular access, the dikes should be reinstalled as soon as possible, but always at the end of the workday.
- Silt fence material should be nonwoven fabric. The fabric width should be 36 inches, with a minimum unit weight of 4.0 oz/yd. The dike structure should be 6

gauge 6" x 6" wire mesh folded into triangular form being eighteen (18) inches on each side.

Installation:

- As shown in the diagram (Figure 3-22), the frame should be constructed of 6" x 6", 6 gauge welded wire mesh, 18 inches per side, and wrapped with geotextile fabric the same composition as that used for silt fences.
- Filter fabric should lap over ends six (6) inches to cover dike to dike junction; each junction should be secured by shoat rings.
- Position dike parallel to the contours, with the end of each section closely abutting the adjacent sections.
- There are several options for fastening the filter dike to the ground as shown in Figure 3-22. The fabric skirt may be toed-in with 6 inches of compacted material, or 12 inches of the fabric skirt should extend uphill and be secured with sandbags or a minimum of 3 inches of open graded rock, or with staples or nails. If these two options are not feasible the dike structure may be trenched in 4 inches.
- Triangular sediment filter dikes should be installed across exposed slopes during construction with ends of the dike tied into existing grades to prevent failure and should intercept no more than one acre of runoff.
- When moved to allow vehicular access, the dikes should be reinstalled as soon as possible, but always at the end of the workday.

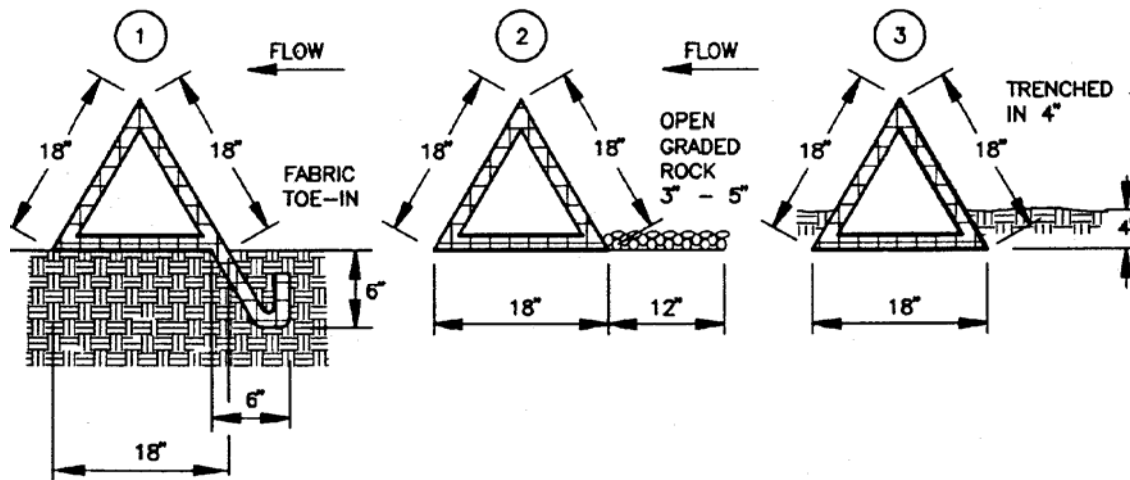

CROSS SECTION OF INSTALLATION OPTIONS

N.T.S.

1. TOE-IN 6" MIN
2. WEIGHTED W/ 3" - 5" OPEN GRADED ROCK
3. TRENCHED IN 4"

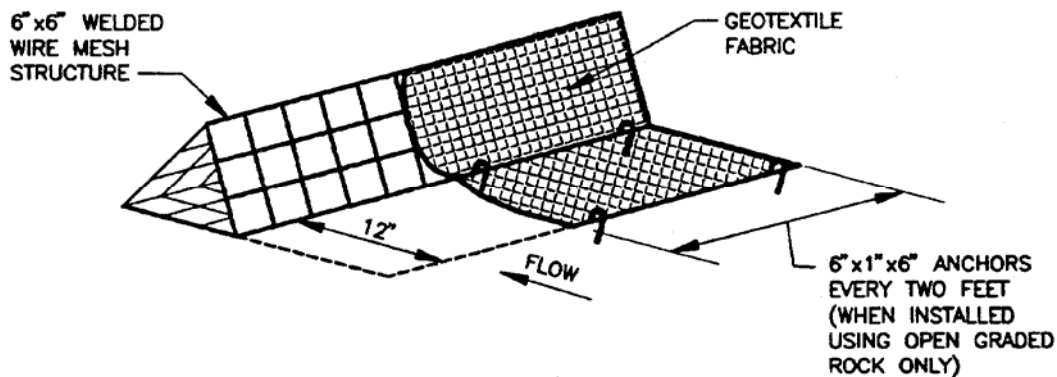

ISOMETRIC PLAN VIEW

N.T.S.

Figure 3-22 Schematic of a Triangular Filter Dike

Note: Triangular filter dikes may be trenched, toed in, or secured with sandbags, open graded rock, staples or nails.

Common Trouble Points:

- Fabric skirt missing, too short, or not securely anchored (flows passing under dike).
- Gap between adjacent dikes (runoff passing between dikes).
- Dike not placed parallel to contour (runoff flowing around dike).

Inspection and Maintenance Guidelines:

- Inspection should be made weekly and after each rainfall event of greater than 0.5 in. and repair or replacement should be made promptly as needed by the contractor.
- Inspect and realign dikes as needed to prevent gaps between sections.
- Accumulated silt should be removed after each 0.5 in. rainfall, and disposed of in a manner which will not cause additional siltation.
- After the site is completely stabilized, the dikes and any remaining silt should be removed. Silt should be disposed of in a manner that will not contribute to additional siltation.

3.3.5 Rock Berms

The purpose of a rock berm is to serve as a check dam in areas of concentrated flow, to intercept sediment-laden runoff, detain the sediment and release the water in sheet flow. The rock berm should be used when the contributing drainage area is less than 5 acres. Rock berms are used in areas where the volume of runoff is too great for a silt fence to contain. They are less effective for sediment removal than silt fences, particularly for fine particles, but are able to withstand higher flows than a silt fence. As such, rock berms are often used in areas of channel flows (ditches, gullies, etc.). Rock berms are most effective at reducing bed load in channels and should not be substituted for other erosion and sediment control measures farther up the watershed.

Materials:

- The berm structure should be secured with a woven wire sheathing having maximum opening of 1 inch and a minimum wire diameter of 20 gauge galvanized and should be secured with shoat rings.
- Clean, open graded 3- to 5-inch diameter rock should be used, except in areas where high velocities or large volumes of flow are expected, where 5- to 8-inch diameter rocks may be used.

Installation:

- Lay out the woven wire sheathing perpendicular to the flow line. The sheathing should be 20 gauge woven wire mesh with 1 inch openings.
- Berm should have a top width of 2 feet minimum with side slopes being 2:1 (H:V) or flatter.

- Place the rock along the sheathing as shown in the diagram (Figure 3-23), to a height not less than 18”.
- Wrap the wire sheathing around the rock and secure with tie wire so that the ends of the sheathing overlap at least 2 inches, and the berm retains its shape when walked upon.
- Berm should be built along the contour at zero percent grade or as near as possible.
- The ends of the berm should be tied into existing upslope grade and the berm should be buried in a trench approximately 3 to 4 inches deep to prevent failure of the control.
- Follow Table 3-19 Rock Berm Spacing on Channels.

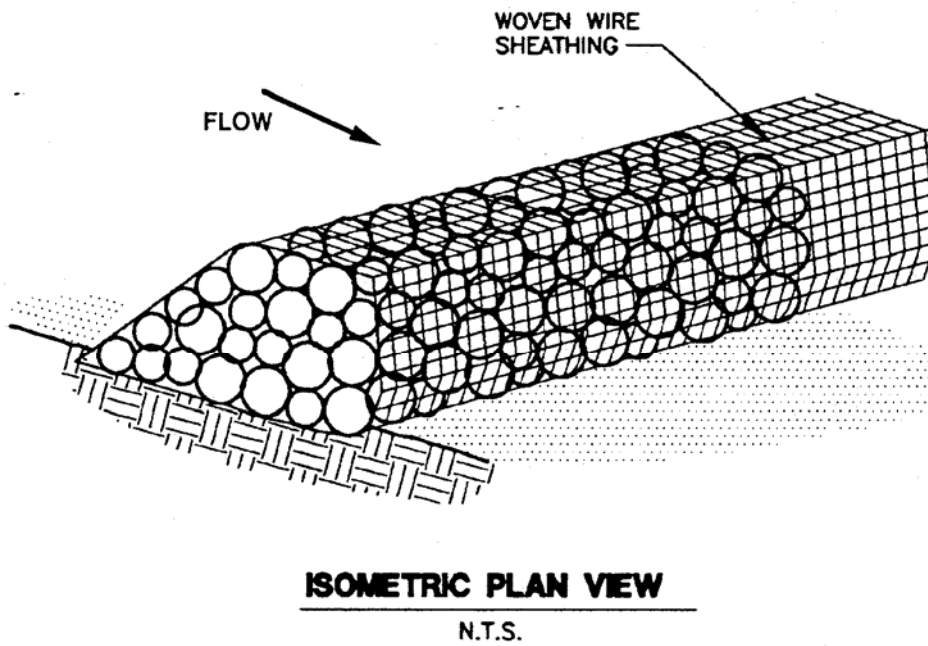
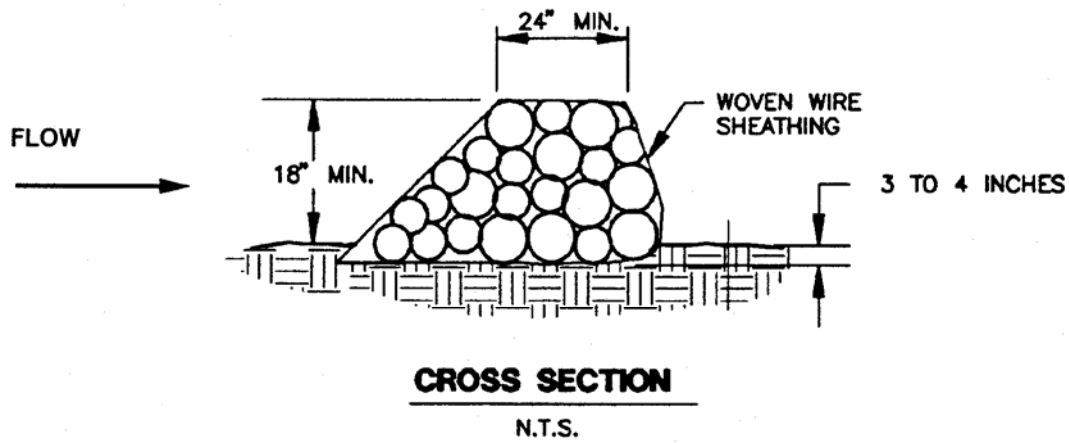

Figure 3-23 Schematic Diagram of a Rock Berm

Common Trouble Points:

- Insufficient berm height or length (runoff quickly escapes over the top or around the sides of berm)
- Berm not installed perpendicular to flow line (runoff escaping around one side)

Inspection and Maintenance Guidelines:

- Inspection should be made weekly and after each rainfall by the responsible party. For installations in streambeds, additional daily inspections should be made.
- Remove sediment and other debris when buildup reaches 6 inches and dispose of the accumulated silt in an approved manner that will not cause any additional siltation.
- Repair any loose wire sheathing.
- The berm should be reshaped as needed during inspection.
- The berm should be replaced when the structure ceases to function as intended due to silt accumulation among the rocks, washout, construction traffic damage, etc.
- The rock berm should be left in place until all upstream areas are stabilized and accumulated silt removed.

3.3.6 High Service Rock Berms

A high service rock berm should be designated in areas of important environmental significance such as in steep canyons or above permanent springs, pools, recharge features, or other environmentally sensitive areas that may require a higher level of protection. This type of sediment barrier combines the characteristics of a silt fence and a rock berm to provide a substantial level of sediment reduction and a sturdy enough barrier to withstand higher flows. The drainage area to this device should not exceed 5 acres and the slope should be less than 30%.

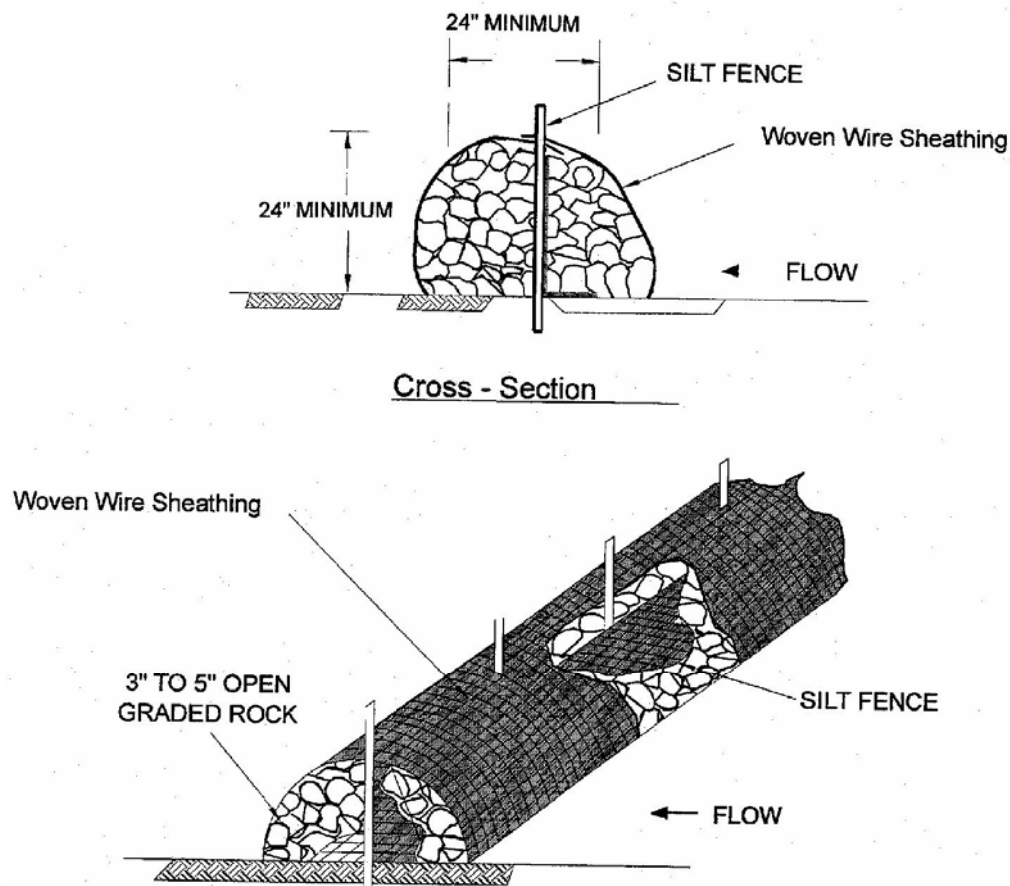

Figure 3-24 Schematic Diagram of High Service Rock Berm

Materials:

- Silt fence material should be nonwoven fabric. The fabric width should be 36 inches, with a minimum unit weight of 4.0 oz/yd².
- Fence posts should be made of hot rolled steel, at least 4 feet long with Tee or Y-bar cross section, surface painted or galvanized, minimum nominal weight 1.25 lb/ft², and Brindell hardness exceeding 140. Rebar (either #5 or #6) may also be used to anchor the berm.
- Woven wire backing to support the fabric should be galvanized 2" x 4" welded wire, 12 gauge minimum.

- The berm structure should be secured with a woven wire sheathing having maximum opening of 1 inch and a minimum wire diameter of 20 gauge galvanized and should be secured with shoat rings.
- Clean, open graded 3- to 5-inch diameter rock should be used, except in areas where high velocities or large volumes of flow are expected, where 5- to 8-inch diameter rocks may be used.

Installation:

- Lay out the woven wire sheathing perpendicular to the flow line. The sheathing should be 20 gauge woven wire mesh with 1-inch openings.
- Install the silt fence along the center of the proposed berm placement, as with a normal silt fence described in Section 2.4.3.
- Place the rock along the sheathing on both sides of the silt fence as shown in the diagram (Figure 3-24), to a height not less than 24 inches. Clean, open graded 3-5" diameter rock should be used, except in areas where high velocities or large volumes of flow are expected, where 5- to 8-inch diameter rock may be used.
- Wrap the wire sheathing around the rock and secure with tie wire so that the ends of the sheathing overlap at least 2 inches, and the berm retains its shape when walked upon.
- The high service rock berm should be removed when the site is revegetated or otherwise stabilized or it may remain in place as a permanent BMP if drainage is adequate.
- Follow spacing guidelines on Table 3-19 Rock Berm Spacing on Channels.

Common Trouble Points:

- Insufficient berm height or length (runoff quickly escapes over top or around sides of berm).
- Berm not installed perpendicular to flow line (runoff escaping around one side).
- Internal silt fence not anchored securely to ground (high flows displacing berm).
- When installed in streambeds, they often result in diversion scour, so their use in this setting is not recommended.

Inspection and Maintenance Guidelines:

- Inspection should be made weekly and after each rainfall by the responsible party. For installations in streambeds, additional daily inspections should be made on rock berm.
- Remove sediment and other debris when buildup reaches 6 inches and dispose of the accumulated silt of in an approved manner.
- Repair any loose wire sheathing.
- The berm should be reshaped as needed during inspection.
- The berm should be replaced when the structure ceases to function as intended due to silt accumulation among the rocks, washout, construction traffic damage, etc.
- The rock berm should be left in place until all upstream areas are stabilized and accumulated silt removed.

3.3.7 Brush Berms

Organic litter and spoil material from site clearing operations is usually burned or hauled away to be dumped elsewhere. Much of this material can be used effectively on the construction site itself. In areas where dense juniper (know locally as “cedar”) thickets must be cleared, construction of brush berms from the cut juniper branches can be an effective alternative to installation of silt fences. The key to constructing an efficient brush berm is in the method used to obtain and place the brush. It will not be acceptable to simply take a bulldozer and push whole trees into a pile. This method does not assure continuous ground contact with the berm and will allow uncontrolled flows under the berm.

Brush berms may be used where there is little or no concentration of water in a channel or other drainage way above the berm. The size of the drainage area should be no greater than one-fourth of an acre per 100 feet of barrier length; the maximum slope length behind the barrier should not exceed 100 feet; and the maximum slope gradient behind the barrier should be less than 50 percent (2:1). Figure 3-25 illustrates a brush berm.

Materials:

- The brush should consist of woody brush and branches, preferably juniper less than 2 inches in diameter.
- The filter fabric should conform to the specifications for filter fence fabric.

- The rope should be ¼ inch polypropylene or nylon rope.
- The anchors should be 3/8-inch diameter rebar stakes that are 18-inches long.

Guidelines for installation:

- Lay out the brush berm following the contour as closely as possible.
- The juniper limbs should be cut and hand placed with the vegetated part of the limb in close contact with the ground. Each subsequent branch should overlap the previous branch providing a shingle effect.
- The brush berm should be constructed in lifts with each layer extending the entire length of the berm before the next layer is started.
- Drive the rope anchors into the ground at approximately a 45 degree angle to the ground. The anchors should be place alternately on 6 foot centers on both sides of the berm so that there is no more than 6 feet between stakes on any one side of the berm.
- Fasten the rope to the anchors and tighten berm securely to the ground.
- The height of the brush berm should be a minimum of 24” after the securing ropes have been tightened.

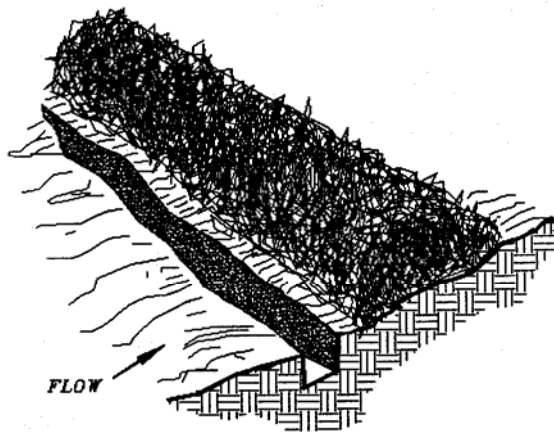

1. EXCAVATE A 4" X 4" TRENCH ALONG THE UPHILL EDGE OF THE BRUSH BARRIER.

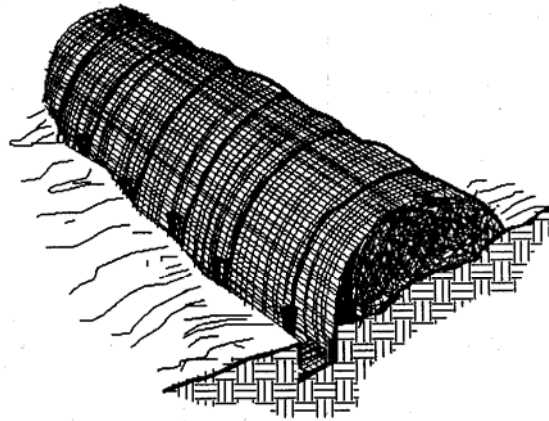

2. DRAPE FILTER FABRIC OVER THE BRUSH BARRIER AND INTO THE TRENCH. FABRIC SHOULD BE SECURED IN THE TRENCH WITH STAKES SET APPROXIMATELY 36" O.C.

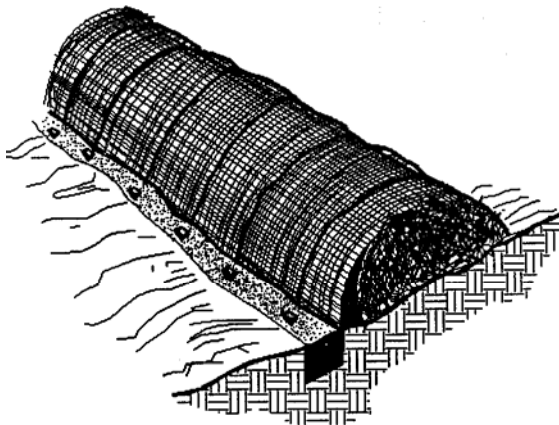

3. BACKFILL AND COMPACT THE EXCAVATED SOIL.

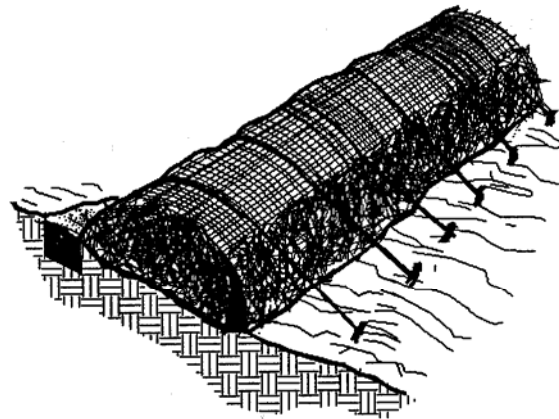

4. SET STAKES ALONG THE DOWNHILL EDGE OF THE BRUSH BARRIER, AND ANCHOR BY TYING TWINE FROM THE FABRIC TO THE STAKES.

Figure 3-25 Schematic Diagram of a Brush Berm

Note: Filter fabric may be required in higher velocity situations.

- A trench should be excavated 6-inches wide and 4-inches deep along the length of the barrier and immediately uphill from the barrier.
- The filter fabric should be cut into lengths sufficient to lay across the barrier from its up-slope base to just beyond its peak. The lengths of filter fabric should be draped across the width of the barrier with the uphill edge placed in the trench and

the edges of adjacent pieces overlapping each other. Where joints are necessary, the fabric should be spliced together with a minimum 6-inch overlap and securely sealed.

- The trench should be backfilled and the soil compacted over the filter fabric.
- Set stakes into the ground along the downhill edge of the brush barrier, and anchor the fabric by tying rope from the fabric to the stakes. Drive the rope anchors into the ground at approximately a 45-degree angle to the ground on 6-foot centers.
- Fasten the rope to the anchors and tighten berm securely to the ground with a minimum tension of 50 pounds.
- The height of the brush berm should be a minimum of 24 inches after the securing ropes have been tightened.
- Follow spacing guidelines on Table 3-19 Silt Fence, Berm and Roll Spacing on Sloping Sites.

Common Trouble Points:

- Gaps between berm and ground due to uneven ground surface, inadequately compacted berm, or inadequately secured berm (runoff passing directly under berm).
- Berm receiving excessive volumes or velocities of flow (runoff overtopping or displacing berm).

Inspection and Maintenance Guidelines:

- The area upstream from the brush berm should be maintained in a condition that will allow accumulated silt to be removed following the runoff of a rainfall event.
- The berm should be inspected weekly or after each rainfall event.
- When the silt reaches a depth of 6 inches it should be removed and disposed of appropriately and in a manner that will not contribute to additional siltation.
- Periodic tightening of the anchoring ropes may be required due to shrinkage of the brush berm as it deteriorates over time;
- Brush berms should be replaced after 3 months or be repaired or reconstructed when loss of foliage occurs or, in the opinion of the TCEQ, they no longer function as intended.

3.3.8 Check Dams

Check dams are small barriers consisting of rock or earthen berms placed across a drainage swale or ditch. They reduce the velocity of small concentrated flows, provide a limited barrier for sediment and help disperse concentrated flows, reducing potential erosion.

They are used primarily in long drainage swales or ditches in which permanent vegetation may not be established and erosive velocities are present. They are typically used in conjunction with other techniques such as inlet protection, riprap or other sediment reduction techniques. Check dams provide limited treatment. They are more useful in reducing flow to acceptable levels for other techniques (NCTCOG, 1993b).

Although check dams are effective in reducing flow velocity and thereby lowering the potential for channel erosion, it is usually better to establish a protective vegetative lining before flow is confined or to install a structural channel lining. However, under circumstances where this is not feasible, check dams are useful.

Materials:

Although many different types of material can be used to create check dams, aggregate and riprap produce a more stable structure.

- If the drainage area is less than 2 acres, coarse aggregate alone can be used for the dam.
- For drainage areas between 2 and 10 acres, a combination of coarse aggregate and riprap as shown in Figure 3-26 should be used.

Guidelines for installation:

- The dam height should be between 18 and 36 inches.
- The center of the check dam should be at least 6 inches lower than the outer edges. Field experience has shown that many dams are not constructed to promote this “weir” effect. Stormwater flows are then forced to the stone-soil interface, thereby promoting scour at that point and subsequent failure of the structure to perform its intended function.
- The dam should be designed so that the 1-year, 3-hour storm or design storm for the water conveyance, whichever is greater, can pass the dam without causing excessive upstream flooding.

2 ACRES OR LESS OF DRAINAGE AREA:

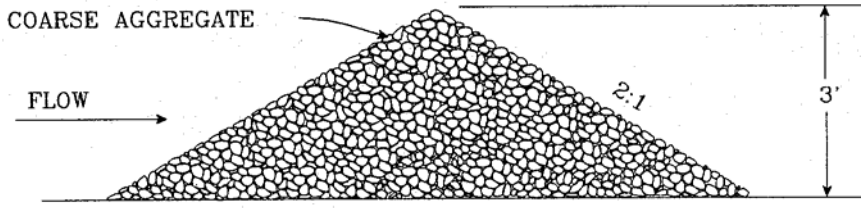
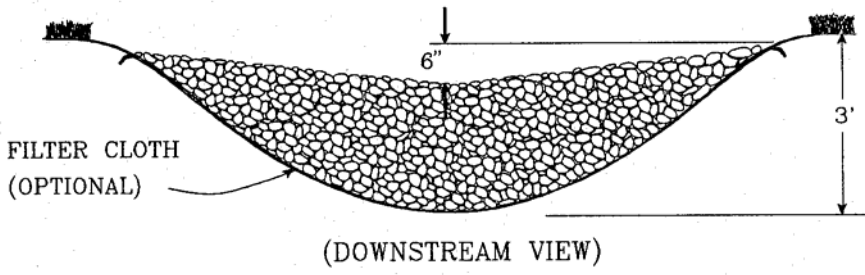

2-10 ACRES OF DRAINAGE AREA:

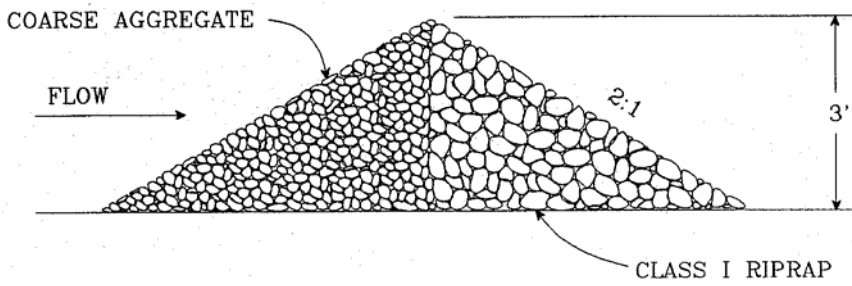
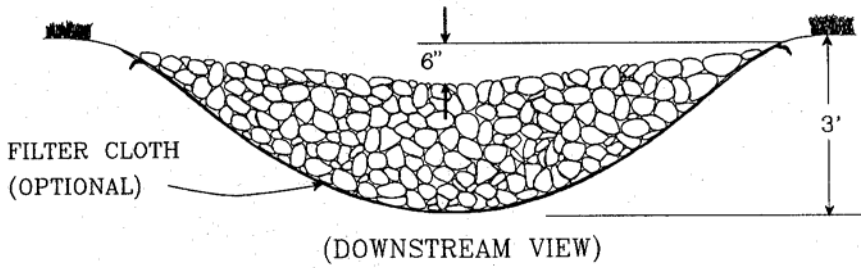

Figure 3-26 Diagram of a Rock Check Dam

- For added stability, the base of the check dam can be keyed into the soil approximately 6 inches.
- The maximum spacing between the dams should be such that the toe of the upstream dam is at the same elevation as the top of the downstream dam. Follow spacing guidelines on Figure 3-19 Rock Berm Spacing on Channels.
- Stone should be placed according to the configuration in Figure 3-26. Hand or mechanical placement will be necessary to achieve complete coverage of the ditch or swale and to insure that the center of the dam is lower than the edges.
- Filter cloth may be used under the stone to provide a stable foundation and to facilitate the removal of the stone.

Common Trouble Points:

- Check dams installed in grass-lined channels may kill the vegetative lining if submergence after rains is too long and/or silting is excessive.
- If check dams are used in grass-lined channels that will be mowed, care should be taken to remove all the stone when the dam is removed. Stones often wash downstream and can damage mowing equipment and present a safety hazard.

Inspection and Maintenance Guidelines:

- Check dams should be inspected and checked for sediment accumulation after each runoff-producing storm event.
- Sediment should be removed when it reaches one half of the original height of the measure.
- Regular inspections should be made to insure that the center of the dam is lower than the edges. Erosion caused by high flows around the edges of the dam should be corrected immediately.

3.3.9 Vegetative Buffers

Buffer zones are undisturbed strips of natural vegetation or an established suitable planting that will provide a living filter to reduce soil erosion and runoff velocities from construction activities. Natural buffer zones are used along streams and other bodies of water that need protection from erosion and sedimentation. Vegetative buffers can be used to protect natural swales and be incorporated into natural landscaping of an area. They can provide critical habitat adjacent to streams and wetlands, as well as assisting in controlling erosion, especially on unstable steep slopes.

The buffer zone can be an area of vegetation that is left undisturbed during construction, or it can be newly planted. If buffer zones are preserved, existing vegetation, good planning, and site management are needed to prevent disturbances such as grade changes, excavation, damage from equipment, and other activities. The creation of new buffer strips requires the establishment of a good dense turf (at least 80% coverage) and can include trees and shrubs. The slope cannot exceed 12 percent. The minimum width of a vegetative buffer used for sediment control should be 50 feet.

Guidelines for installation:

- Preserving natural vegetation or plantings in clumps, blocks, or strips is generally the easiest and most successful method.
- All unstable steep slopes should be left in natural vegetation.
- Fence or flag clearing limits and keep all equipment and construction debris out of the natural areas.
- Keep all excavations outside the drip-line of trees and shrubs.
- Debris or extra soil should not be pushed into the buffer zone area because it will cause damage from burying and smothering.
- The minimum width of a vegetative buffer used for sediment control should be 50 feet.

Inspection and Maintenance Guidelines:

Inspection and careful maintenance are important to ensure healthy vegetation. The need for routine maintenance such as mowing, fertilizing, irrigating, and weed and pest control will depend on the species of plants and trees, soil types, location and climatic conditions. County agricultural extension agencies are a good source for this type of information.

3.3.10 Inlet Protection

Storm sewers that are made operational prior to stabilization of the associated drainage areas can convey large amounts of sediment to natural drainage ways. In case of extreme sediment loading, the storm sewer itself may clog and lose a major portion of its capacity. To avoid these problems, it is necessary to prevent sediment from entering the system at the inlets. The following guidelines for inlet protection are based primarily on recommendations by the Virginia Dept. of Conservation and Recreation (1992) and the North Central Texas Council of Governments (NCTCOG, 1993b).

In developments for which drainage is to be conveyed by underground storm sewers (i.e., streets with curbs and gutters), all inlets that may receive storm runoff from disturbed areas should be protected. Temporary inlet protection is a series of different measures that provide protection against silt transport or accumulation in storm sewer systems. This clogging can greatly reduce or completely stop the flow in the pipes. The different measures are used for different site conditions and inlet types.

Care should be taken when choosing a specific type of inlet protection. Field experience has shown that inlet protection that causes excessive ponding in an area of high construction activity may become so inconvenient that it is removed or bypassed, thus transmitting sediment-laden flows unchecked. In such situations, a structure with an adequate overflow mechanism should be utilized.

It should also be noted that inlet protection devices are designed to be installed on construction sites and not on streets and roads open to the public. **When used on public streets these devices will cause ponding of runoff, which can cause flooding and can present a traffic hazard.** An example of appropriate siting would be a new subdivision where the storm drain system is installed before the area is stabilized and the streets open to the general public. When construction occurs adjacent to active streets, the sediment should be controlled on site and not on public thoroughfares. Occasionally, roadwork or utility installation will occur on public roads. In these cases, inlet protection is an appropriate temporary BMP.

The following inlet protection devices are for drainage areas of one acre or less. Runoff from larger disturbed areas should be routed to a temporary sediment trap or basin.

Filter barrier protection using silt fence is appropriate when the drainage area is less than one acre and the basin slope is less than five percent. This type of protection is not applicable in paved areas.

Block and gravel protection is used when flows exceed 0.5 cubic feet per second and it is necessary to allow for overtopping to prevent flooding. This form of protection is also useful for curb type inlets as it works well in paved areas.

Wire mesh and gravel protection is used when flows exceed 0.5 cubic feet per second and construction traffic may occur over the inlet. This form of protection may be used with both curb and drop inlets.

Excavated impoundment protection around a drop inlet may be used for protection against sediment entering a storm drain inlet. With this method, it is necessary to install weep holes to allow the impoundment to drain completely. If this measure is implemented, the impoundment should be sized such that the volume of excavation is 3,600 cubic feet per acre (equivalent to 1 inch of runoff) of disturbed area entering the inlet.

Materials:

- Filter fabric should be a nonwoven fence with a minimum weight of 4.0 oz/yd².
- Posts for fabric should be 2" x 4" pressure treated wood stakes or galvanized steel, tubular in cross-section or they may be standard fence "T" posts.
- Concrete blocks should be standard 8" x 8" x 16" concrete masonry units.
- Wire mesh should be standard hardware cloth or comparable wire mesh with an opening size not to exceed 1/2 inch.
- The sand bag material should be polypropylene, polyethylene, polyamide or cotton burlap woven fabric, minimum unit weight 4 oz/yd², mullen burst strength exceeding 300 psi and ultraviolet stability exceeding 70 percent.
- The bag length should be 24 to 30 inches, width should be 16 to 18 inches and thickness should be 6 to 8 inches.
- Sandbags should be filled with coarse grade sand, free from deleterious material. All sand should pass through a No. 10 sieve. The filled bag should have an approximate weight of 40 pounds and stapled or tied with nylon or poly cord.

Guidelines for installation:

Silt Fence Drop Inlet Protection

- Silt fence should conform to the specifications listed above and should be cut from a continuous roll to avoid joints.
- For stakes, use 2 x 4-inch wood or equivalent metal with a minimum length of 3 feet.
- Space stakes evenly around the perimeter of the inlet a maximum of 3 feet apart, and securely drive them into the ground, approximately 18 inches deep (Figure 3-27).

- To provide needed stability to the installation, a frame with 2 x 4-inch wood strips around the crest of the overflow area at a maximum of 1½ feet above the drop inlet crest should be provided.

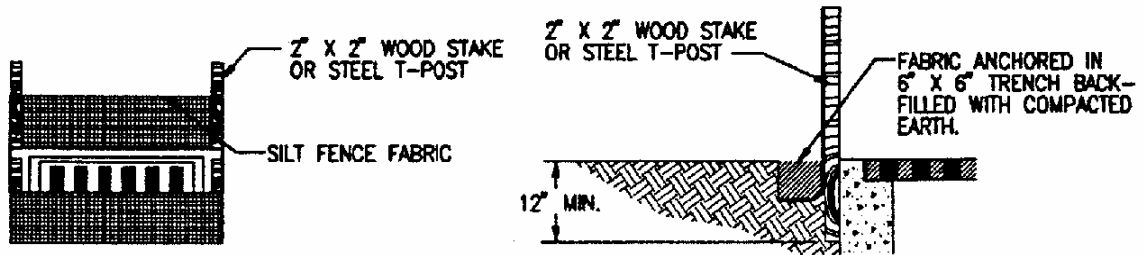

Figure 3-27 Filter Fabric Inlet Protection

- Place the bottom 12 inches of the fabric in a trench and backfill the trench with 12 inches of compacted soil.
- Fasten fabric securely by staples or wire to the stakes and frame. Joints must be overlapped to the next stake.
- It may be necessary to build a temporary dike on the down slope side of the structure to prevent bypass flow.

If the drop inlet is above the finished grade, the grate may be completely covered with filter fabric. The fabric should be securely attached to the entire perimeter of the inlet using 1"x 2" wood strips and appropriate fasteners.

Curb Inlet Protection with 2-inch x 4-inch Wooden Weir

- Attach a continuous piece of wire mesh (30-inch minimum width x inlet throat length plus 4 feet) to the 2-inch x 4-inch wooden weir (with a total length of throat length plus 2 feet) as shown in Figure 3-28. Wood should be "construction grade" lumber.
- Place a piece of approved filter cloth of the same dimensions as the wire mesh over the wire mesh and securely attach to the 2-inch x 4-inch weir.
- Securely nail the 2-inch x 4-inch weir to the 9-inch long vertical spacers which are to be located between the weir and inlet face at a maximum 6-foot spacing.
- Place the assembly against the inlet throat and nail 2-foot (minimum) lengths of 2-inch x 4-inch board to the top of the weir at spacer locations. These 2-inch x 4-inch anchors should extend across the inlet tops and be held in place by sandbags or alternate weight.
- The assembly should be placed so that the end spacers are a minimum 1 foot beyond both ends of the throat opening.

Sandbags may be used instead of loose gravel.

Common Trouble Points:

- Gaps between the inlet protection and the curb (flows bypass around side of filter).
- Filter fabric skirt not anchored to pavement (flows pass under filter).

3.3.11 Stone Outlet Sediment Trap

A stone outlet sediment trap is an impoundment created by the placement of an earthen and stone embankment to prevent soil and sediment loss from a site. The purpose of a sediment trap is to intercept sediment-laden runoff and trap the sediment in order to protect drainage ways, properties and rights of way below the sediment trap from sedimentation. A sediment trap is usually installed at points of discharge from disturbed areas. The drainage area for a sediment trap is recommended to be less than 5 acres. Larger areas should be treated using a sediment basin. A sediment trap differs from a sediment basin mainly in the type of discharge structure. A schematic of a sediment trap is shown in Figure 3-29.

The trap should be located to obtain the maximum storage benefit from the terrain, for ease of cleanout and disposal of the trapped sediment and to minimize interference with construction activities. The volume of the trap should be at least 1800 cubic feet per acre of drainage area.

Materials:

- All aggregate should be at least 3 inches in diameter and should not exceed a volume of 0.5 cubic foot.
- The geotextile fabric specification should be woven polypropylene, polyethylene or polyamide geotextile, minimum unit weight of 4.0 oz/yd², mullen burst strength at least 250 lb/in², ultraviolet stability exceeding 70%, and equivalent opening size exceeding 40.

Installation:

- Earth Embankment: Place fill material in layers not more than 8 inches in loose depth. Before compaction, moisten or aerate each layer as necessary to provide the optimum moisture content of the material. Compact each layer to 95 percent standard proctor density. Do not place material on surfaces that are muddy or frozen. Side slopes

for the embankment are to be 3:1. The minimum width of the embankment should be 3 feet.

- A gap is to be left in the embankment in the location where the natural confluence of runoff crosses the embankment line. The gap is to have a width in feet equal to 6 times the drainage area in acres.
- **Geotextile Covered Rock Core:** A core of filter stone having a minimum height of 1.5 feet and a minimum width at the base of 3 feet should be placed across the opening of the earth embankment and should be covered by geotextile fabric which should extend a minimum distance of 2 feet in either direction from the base of the filter stone core.
- **Filter Stone Embankment:** Filter stone should be placed over the geotextile and is to have a side slope which matches that of the earth embankment of 3:1 and should cover the geotextile/rock core a minimum of 6 inches when installation is complete. The crest of the outlet should be at least 1 foot below the top of the embankment.

Common Trouble Points:

- Can cause minor flooding upstream of dam, impacting construction operations.
- The cost of construction, availability of materials, and the amount of land required limit the application of this measure.

Inspection and Maintenance Guidelines:

- Inspection should be made weekly and after each rainfall. Check the embankment, spillways, and outlet for erosion damage, and inspect the embankment for piping and settlement. Repair should be made promptly as needed by the contractor.
- Trash and other debris should be removed after each rainfall to prevent clogging of the outlet structure.
- Sediment should be removed and the trap restored to its original dimensions when the sediment has accumulated to half of the design depth of the trap.
- Sediment removed from the trap should be deposited in an approved spoils area and in such a manner that it will not cause additional siltation.

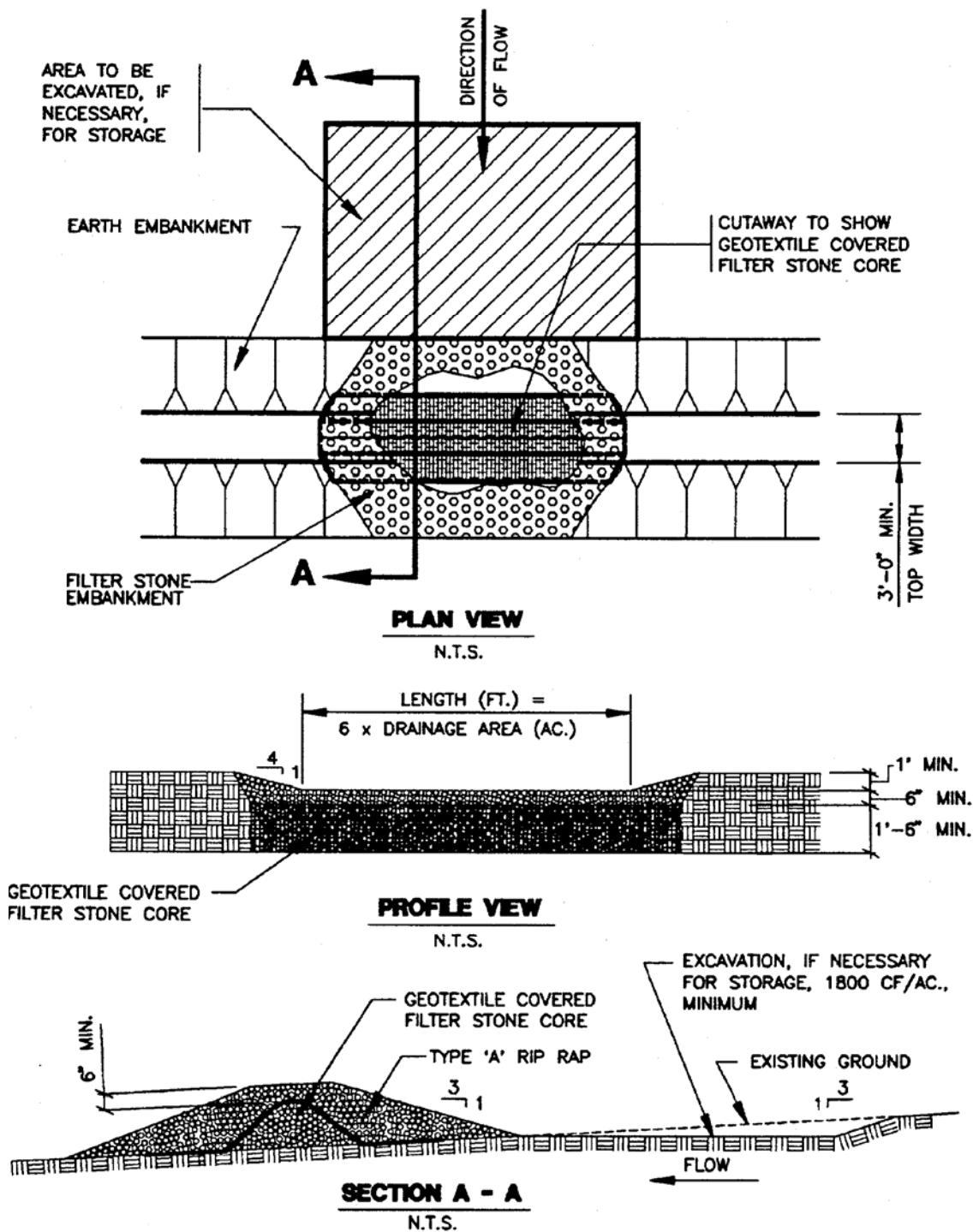

Figure 3-29 Schematic Diagram of a Sediment Trap

3.3.12 Sediment Basins

The purpose of a sediment basin is to intercept sediment-laden runoff and trap the sediment in order to protect drainage ways, properties and rights of way below the sediment basin from sedimentation. A sediment basin is usually installed at points of discharge from disturbed areas. The drainage area for a sediment basin is recommended to be less than 100 acres and located off the existing creek or channel.

Sediment basins are effective for capturing and slowly releasing the runoff from larger disturbed areas thereby allowing sedimentation to take place. A sediment basin can be created where a permanent pond BMP is being constructed. Guidelines for construction of the permanent BMP should be followed, but revegetation, placement of underdrain piping, and installation of sand or other filter media should not be carried out until the site construction phase is complete. A schematic of a sediment basin is shown in Figure 3-30.

Materials:

- Riser should be corrugated metal or reinforced concrete pipe or box and should have watertight fittings or end to end connections of sections.
- An outlet pipe of corrugated metal or reinforced concrete should be attached to the riser and should have positive flow to a stabilized outlet on the downstream side of the embankment.
- An anti-vortex device and rubbish screen should be attached to the top of the riser and should be made of polyvinyl chloride or corrugated metal.

Basin Design and Construction:

- For common drainage locations that serve an area with ten or more acres disturbed at one time, the sediment basin volume should be 1800 cubic feet of storage for each disturbed acre.
- The basin length to width ratio should be at least 2:1 to improve trapping efficiency. The shape may be attained by excavation or the use of baffles. The lengths should be measured at the elevation of the riser de-watering hole.
- Place fill material in layers not more than 8 inches in loose depth. Before compaction, moisten or aerate each layer as necessary to provide the optimum moisture content of the material. Compact each layer to 95 percent standard proctor density. Do not place material on surfaces that are muddy or frozen. Side slopes for the embankment should be 3:1 (H:V).

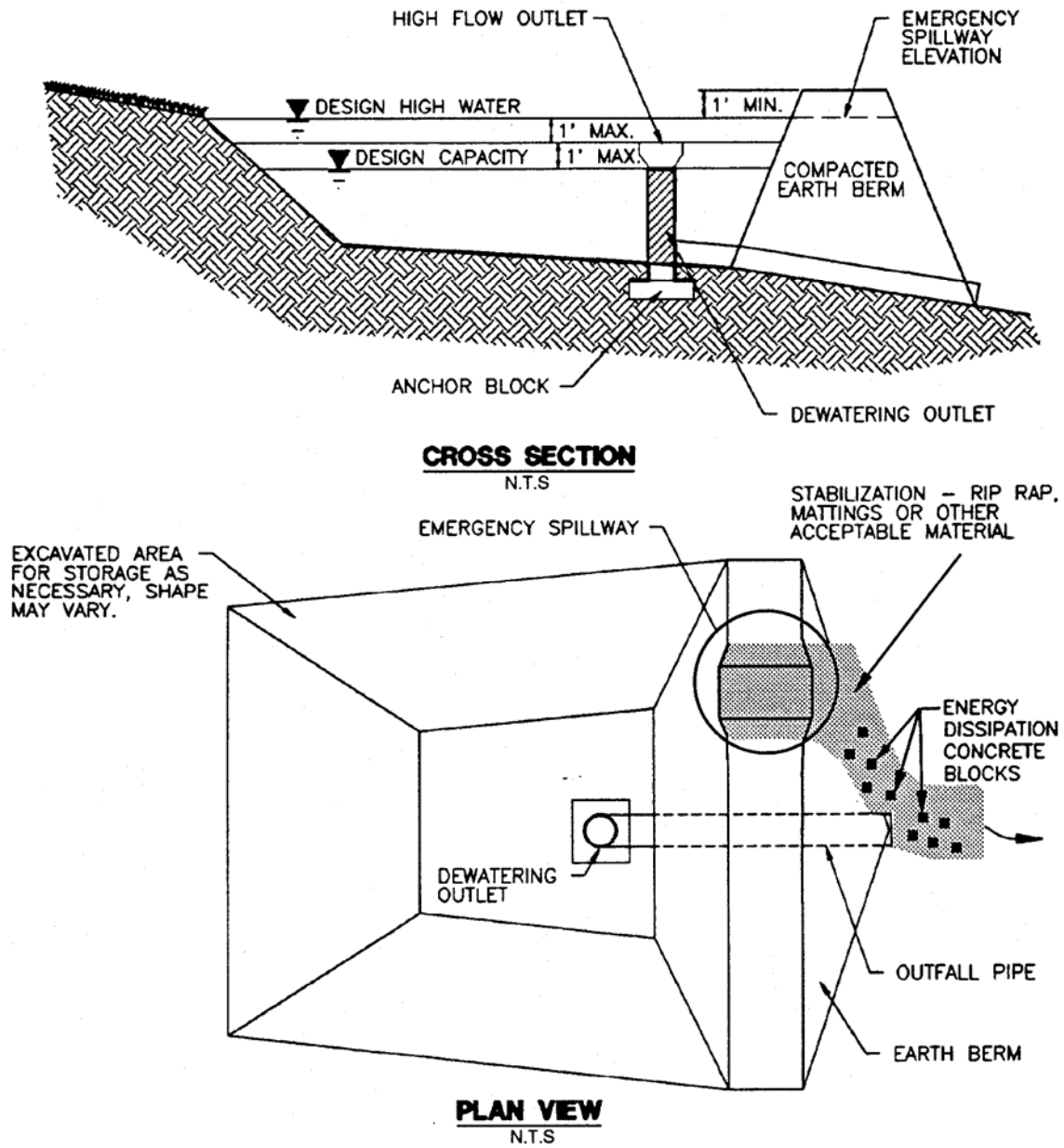

Figure 3-30 Schematic of a Sediment Basin

- An emergency spillway should be installed adjacent to the embankment on undisturbed soil and should be sized to carry the full amount of flow generated by a 10-year, 3-hour storm with 1 foot of freeboard less the amount which can be carried by the principal outlet control device.
- The emergency spillway should be lined with riprap as should the swale leading from the spillway to the normal watercourse at the base of the embankment.
- The principal outlet control device should consist of a rigid vertically oriented pipe or box of corrugated metal or reinforced concrete. Attached to this structure should be a horizontal pipe, which should extend through the embankment to the toe of fill to provide a de-watering outlet for the basin.
- An anti-vortex device should be attached to the inlet portion of the principal outlet control device to serve as a rubbish screen.
- A concrete base should be used to anchor the principal outlet control device and should be sized to provide a safety factor of 1.5 (downward forces = 1.5 buoyant forces).
- The basin should include a permanent stake to indicate the sediment level in the pool and marked to indicate when the sediment occupies 50% of the basin volume (not the top of the stake).
- The top of the riser pipe should remain open and be guarded with a trash rack and anti-vortex device. The top of the riser should be 12 inches below the elevation of the emergency spillway. The riser should be sized to convey the runoff from the 1-year, 3-hour storm when the water surface is at the emergency spillway elevation. For basins with no spillway the riser must be sized to convey the runoff from the 10-year, 3-hour storm.
- Anti-seep collars should be included when soil conditions or length of service make piping through the backfill a possibility.
- The 48-hour drawdown time will be achieved by using a riser pipe perforated at the point measured from the bottom of the riser pipe equal to ½ the volume of the basin. This is the maximum sediment storage elevation. The size of the perforation may be calculated as follows:

Equation 3. $A_o = [A_s * (2h)^{0.5}] / [C_d * 980,000]$

Where: A_o = Area of the de-watering perforation, ft²
 A_s = Surface area of the basin, ft²
 C_d = Coefficient of contraction, approximately 0.6
 h = head of water above the perforation, ft

Perforating the riser with multiple holes with a combined surface area equal to A_o is acceptable.

Common Trouble Points:

- Storm events that exceed the design storm event can cause damage to the spillway structure of the basin and may cause adverse impacts downstream.
- Piping (flow occurring in the fill material) around outlet pipe can cause failure of the embankment.

Inspection and Maintenance Guidelines:

- Inspection should be made weekly and after each rainfall. Check the embankment, spillways, and outlet for erosion damage, and inspect the embankment for piping and settlement. Repair should be made promptly as needed by the contractor.
- Trash and other debris should be removed after each rainfall to prevent clogging of the outlet structure.
- Accumulated silt should be removed and the basin should be re-graded to its original dimensions at such point that the capacity of the impoundment has been reduced to 75% of its original storage capacity.
- The removed sediment should be stockpiled or redistributed in areas that are protected from erosion.

3.3.13 Fiber Rolls

A fiber roll consists of straw, coconut fibers, or other similar materials bound into a tight tubular roll. When fiber rolls are placed at the toe and on the face of slopes, they intercept runoff, reduce its flow velocity, release the runoff as sheet flow, and provide removal of sediment from the runoff. By interrupting the length of a slope, fiber rolls can also reduce erosion.

Fiber rolls may be suitable:

- Along the toe, top, face, and at grade breaks of exposed and erodible slopes to shorten slope length and spread runoff as sheet flow
- At the end of a downward slope where it transitions to a steeper slope
- Along the perimeter of a project
- As check dams in unlined ditches
- Down-slope of exposed soil areas
- Around temporary stockpiles

Limitations:

- Fiber rolls are not effective unless trenched
- Fiber rolls at the toe of slopes greater than 5:1 (H:V) should be a minimum of 20 in. diameter or installations achieving the same protection (i.e. stacked smaller diameter fiber rolls, etc.).
- Difficult to move once saturated.
- If not properly staked and trenched in, fiber rolls could be transported by high flows.
- Fiber rolls have a very limited sediment capture zone.
- Fiber rolls should not be used on slopes subject to creep, slumping, or landslide.

Material:

- Core material: Core material should be biodegradable or recyclable. Material may be compost, mulch, aspen wood fibers, chipped site vegetation, agricultural rice or wheat straw, coconut fiber, 100% recyclable fibers, or similar materials.
- Containment Mesh: Containment mesh should be 100% biodegradable, photodegradable or recyclable such as burlap, twine, UV photodegradable plastic, polyester, or similar material. When the fiber roll will remain in place as part of a vegetative system use biodegradable or photodegradable mesh. For temporary installation recyclable mesh is recommended.

Implementation:

- Locate fiber rolls on level contours spaced as follows:
- Slope inclination of 4:1 (H:V) or flatter: Fiber rolls should be placed at a maximum interval of 20 ft.
- Slope inclination between 4:1 and 2:1 (H:V): Fiber Rolls should be placed at a maximum interval of 15 ft. (a closer spacing is more effective).
- Slope inclination 2:1 (H:V) or greater: Fiber Rolls should be placed at a maximum interval of 10 ft. (a closer spacing is more effective).
- Turn the ends of the fiber roll up slope to prevent runoff from going around the roll.
- Stake fiber rolls into a 2 to 4 in. deep trench with a width equal to the diameter of the fiber roll.
- Drive stakes at the end of each fiber roll and spaced 4 ft maximum on center.
- Use wood stakes with a nominal classification of 0.75 by 0.75 in. and minimum length of 24 in.

- If more than one fiber roll is placed in a row, the rolls should be overlapped, not abutted.
- Follow Figure 3-19 Rock Berm spacing on Channels.

Inspection and Maintenance Guidelines:

- Inspect prior to forecast rain, daily during extended rain events, after rain events, and weekly.
- Repair or replace split, torn, unraveling, or slumping fiber rolls.
- If the fiber roll is used as a sediment capture device, or as an erosion control device to maintain sheet flows, sediment that accumulates behind the roll must be periodically removed in order to maintain its effectiveness. Sediment should be removed when the accumulation reaches one-half the designated sediment storage depth, usually one-half the distance between the top of the fiber roll and the adjacent ground surface. Sediment removed during maintenance may be incorporated into earthwork on the site or disposed of at an appropriate location.

3.3.14 Dewatering Operations

Dewatering operations are practices that manage the discharge of pollutants when non-stormwater and accumulated precipitation or groundwater must be removed from a work location so that construction work may be accomplished.

The controls detailed in this BMP only allow for minimal settling time for sediment particles and should only be used when site conditions restrict the use of the other control methods. When possible avoid dewatering discharges by using the water for dust control, by infiltration, allowing to evaporate, etc.

A variety of methods can be used to treat water during dewatering operations. Several devices are presented below and provide options to achieve sediment removal. When pumping water out or through any of these devices, a floatation device should be attached to the pump inlet.

Sediment controls are low to high cost measures depending on the dewatering system that is selected. Pressurized filters tend to be more expensive than gravity settling, but are often more effective. Simple tanks are generally rented on a long-term basis (one or more months). Mobilization and demobilization costs vary considerably.

Inspection and Maintenance

- Inspect and verify that activity-based BMPs are in place prior to the commencement of associated activities. While activities associated with the BMP are under way, inspect weekly and after every 0.5 in. or greater rainfall event to verify continued BMP implementation.
- Inspect BMPs subject to non-stormwater discharges daily while non-stormwater discharges occur.
- Unit-specific maintenance requirements are included with the description of each technology.
- Sediment removed during the maintenance of a dewatering device may be either spread onsite and stabilized, or disposed of at a disposal site.
- Sediment that is commingled with other pollutants must be disposed of in accordance with all applicable laws and regulations.

Weir Tanks

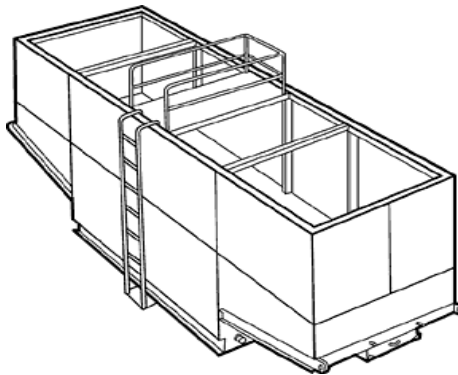

Description:

A weir tank separates water and waste by using weirs. The configuration of the weirs (over and under weirs) maximizes the residence time in the tank and determines the waste to be removed from the water, such as oil, grease, and sediments.

Appropriate Applications:

The tank removes trash, some settleable solids (gravel, sand, and silt), some visible oil and grease, and some metals (removed with sediment). To achieve high levels of flow, multiple tanks can be used in parallel. If additional treatment is desired, the tanks can be placed in series or as pre-treatment for other methods.

Implementation:

Tanks are delivered to the site by the vendor, who can provide assistance with set-up and operation.

Tank size will depend on flow volume, constituents of concern, and residency period required. Vendors should be consulted to appropriately size tank.

Maintenance:

Periodic cleaning is required based on visual inspection or reduced flow.

Oil and grease disposal must be by licensed waste disposal company.

Dewatering Tanks



Description:

A dewatering tank removes debris and sediment. Flow enters the tank through the top, passes through a fabric filter, and is discharged through the bottom of the tank. The filter separates the solids from the liquids.

Appropriate Applications:

The tank removes trash, gravel, sand, and silt, some visible oil and grease, and some metals (removed with sediment). To achieve high levels of flow, multiple tanks can be used in parallel. If additional treatment is desired, the tanks can be placed in series or as pre-treatment for other methods.

Implementation:

Tanks are delivered to the site by the vendor, who can provide assistance with set-up and operation.

Tank size will depend on flow volume, constituents of concern, and residency period required. Vendors should be consulted to determine appropriate size of tank.

Maintenance:

Periodic cleaning is required based on visual inspection or reduced flow.

Oil and grease disposal must be by licensed waste disposal company.

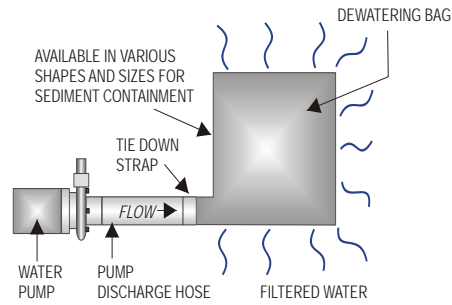

Gravity Bag Filter

Description:

A gravity bag filter, also referred to as a dewatering bag, is a square or rectangular bag made of non-woven geotextile fabric that collects sand, silt, and fines.

Appropriate Applications:

Effective for the removal of sediments (gravel, sand, and silt). Some metals are removed with the sediment.

Implementation:

Water is pumped into one side of the bag and seeps through the bottom and sides of the bag.

A secondary barrier, such as a rock filter bed or straw/hay bale barrier, is placed beneath and beyond the edges of the bag to capture sediments that escape the bag.

Maintenance:

Inspection of the flow conditions, bag condition, bag capacity, and the secondary barrier is required.

Replace the bag when it no longer filters sediment or passes water at a reasonable rate. The bag is disposed of offsite.

3.3.15 Spill Prevention and Control

The objective of this section is to describe measures to prevent or reduce the discharge of pollutants to drainage systems or watercourses from leaks and spills by reducing the chance for spills, stopping the source of spills, containing and cleaning up spills, properly disposing of spill materials, and training employees.

The following steps will help reduce the stormwater impacts of leaks and spills:

Education

- Be aware that different materials pollute in different amounts. Make sure that each employee knows what a “significant spill” is for each material they use, and what is the appropriate response for “significant” and “insignificant” spills. Employees should also be aware of when spill must be reported to the TCEQ. Information available in 30 TAC 327.4 and 40 CFR 302.4.
- Educate employees and subcontractors on potential dangers to humans and the environment from spills and leaks.
- Hold regular meetings to discuss and reinforce appropriate disposal procedures (incorporate into regular safety meetings).
- Establish a continuing education program to indoctrinate new employees.
- Have contractor’s superintendent or representative oversee and enforce proper spill prevention and control measures.

General Measures

- To the extent that the work can be accomplished safely, spills of oil, petroleum products, substances listed under 40 CFR parts 110,117, and 302, and sanitary and septic wastes should be contained and cleaned up immediately.
- Store hazardous materials and wastes in covered containers and protect from vandalism.
- Place a stockpile of spill cleanup materials where it will be readily accessible.
- Train employees in spill prevention and cleanup.
- Designate responsible individuals to oversee and enforce control measures.
- Spills should be covered and protected from stormwater runoff during rainfall to the extent that it doesn’t compromise clean up activities.
- Do not bury or wash spills with water.
- Store and dispose of used clean up materials, contaminated materials, and recovered spill material that is no longer suitable for the intended purpose in conformance with the provisions in applicable BMPs.
- Do not allow water used for cleaning and decontamination to enter storm drains or watercourses. Collect and dispose of contaminated water in accordance with applicable regulations.
- Contain water overflow or minor water spillage and do not allow it to discharge into drainage facilities or watercourses.
- Place Material Safety Data Sheets (MSDS), as well as proper storage, cleanup, and spill reporting instructions for hazardous materials stored or used on the project site in an open, conspicuous, and accessible location.

- Keep waste storage areas clean, well organized, and equipped with ample cleanup supplies as appropriate for the materials being stored. Perimeter controls, containment structures, covers, and liners should be repaired or replaced as needed to maintain proper function.

Cleanup

- Clean up leaks and spills immediately.
- Use a rag for small spills on paved surfaces, a damp mop for general cleanup, and absorbent material for larger spills. If the spilled material is hazardous, then the used cleanup materials are also hazardous and must be disposed of as hazardous waste.
- Never hose down or bury dry material spills. Clean up as much of the material as possible and dispose of properly. See the waste management BMPs in this section for specific information.

Minor Spills

- Minor spills typically involve small quantities of oil, gasoline, paint, etc. which can be controlled by the first responder at the discovery of the spill.
- Use absorbent materials on small spills rather than hosing down or burying the spill.
- Absorbent materials should be promptly removed and disposed of properly.
- Follow the practice below for a minor spill:
- Contain the spread of the spill.
- Recover spilled materials.
- Clean the contaminated area and properly dispose of contaminated materials.

Semi-Significant Spills

Semi-significant spills still can be controlled by the first responder along with the aid of other personnel such as laborers and the foreman, etc. This response may require the cessation of all other activities.

Spills should be cleaned up immediately:

- Contain spread of the spill.
- Notify the project foreman immediately.
- If the spill occurs on paved or impermeable surfaces, clean up using "dry" methods (absorbent materials, cat litter and/or rags). Contain the spill by encircling with absorbent materials and do not let the spill spread widely.

- If the spill occurs in dirt areas, immediately contain the spill by constructing an earthen dike. Dig up and properly dispose of contaminated soil.
- If the spill occurs during rain, cover spill with tarps or other material to prevent contaminating runoff.

Significant/Hazardous Spills

For significant or hazardous spills that are in reportable quantities:

- Notify the TCEQ by telephone as soon as possible and within 24 hours at 512-339-2929 (Austin) between 8 AM and 5 PM. After hours, contact the Environmental Release Hotline at 1-800-832-8224. It is the contractor's responsibility to have all emergency phone numbers at the construction site.
- For spills of federal reportable quantities, in conformance with the requirements in 40 CFR parts 110,119, and 302, the contractor should notify the National Response Center at (800) 424-8802.
- Notification should first be made by telephone and followed up with a written report.
- The services of a spills contractor or a Haz-Mat team should be obtained immediately. Construction personnel should not attempt to clean up until the appropriate and qualified staffs have arrived at the job site.
- Other agencies which may need to be consulted include, but are not limited to, the City Police Department, County Sheriff Office, Fire Departments, etc.

More information on spill rules and appropriate responses is available on the TCEQ website at: http://www.tnrcc.state.tx.us/enforcement/emergency_response.html

Vehicle and Equipment Maintenance

- If maintenance must occur onsite, use a designated area and a secondary containment, located away from drainage courses, to prevent the runoff of stormwater and the runoff of spills.
- Regularly inspect onsite vehicles and equipment for leaks and repair immediately
- Check incoming vehicles and equipment (including delivery trucks, and employee and subcontractor vehicles) for leaking oil and fluids. Do not allow leaking vehicles or equipment onsite.
- Always use secondary containment, such as a drain pan or drop cloth, to catch spills or leaks when removing or changing fluids.
- Place drip pans or absorbent materials under paving equipment when not in use.
- Use absorbent materials on small spills rather than hosing down or burying the spill. Remove the absorbent materials promptly and dispose of properly.

- Promptly transfer used fluids to the proper waste or recycling drums. Don't leave full drip pans or other open containers lying around.
- Oil filters disposed of in trashcans or dumpsters can leak oil and pollute stormwater. Place the oil filter in a funnel over a waste oil-recycling drum to drain excess oil before disposal. Oil filters can also be recycled. Ask the oil supplier or recycler about recycling oil filters.
- Store cracked batteries in a non-leaking secondary container. Do this with all cracked batteries even if you think all the acid has drained out. If you drop a battery, treat it as if it is cracked. Put it into the containment area until you are sure it is not leaking.

Vehicle and Equipment Fueling

- If fueling must occur on site, use designated areas, located away from drainage courses, to prevent the runoff of stormwater and the runoff of spills.
- Discourage "topping off" of fuel tanks.
- Always use secondary containment, such as a drain pan, when fueling to catch spills/ leaks.

3.3.16 Creek Crossings

Creek crossings represent particularly important areas to employ effective erosion and sedimentation control. A temporary stream crossing is used to provide a safe, stable way for construction vehicle traffic to cross a watercourse. Temporary stream crossings provide streambank stabilization, reduce the risk of damage to the streambed or channel, and minimize sediment loading from construction activities and traffic. Underground utility construction and road construction across creeks requires special measures, as detailed below.

General Considerations

- Creek crossings should be made perpendicular to the creek flowline.
- In-stream controls should only be used as a secondary BMP. Stormwater runoff approaching a creek crossing should be diverted to a sediment trapping BMP before it reaches the creek.
- If baseflow is present, LCRA personnel should be consulted, as it may be necessary to divert or pump water around the construction area.
- Every effort should be made to keep the zone of immediate construction free of surface and ground water. For construction in the creek channel, a pipe of adequate size to divert normal stream flow should be provided around the construction area. Diversion may be by pumping or gravity flow using temporary dams
- Where water must be pumped from the construction zone, discharges should be in a manner that will not cause scouring or erosion. All discharges shall be on the upstream or upslope side of emplaced erosion control structures. If discharges are necessary in easily erodible areas, a stabilized, energy-dissipating discharge apron shall be constructed of riprap with minimum stone diameter of 6 inches and minimum depth of 12 inches. Size of the apron in linear dimensions shall be approximately 10 times the diameter of the discharge pipe.

Utility Crossings & Excavations

- Before any trenching or excavation, install two high service rock berms at 100-ft spacing across the channel (perpendicular to the flowline) downstream of the proposed trench. These berms should be located between 100 and 300 feet downstream of the proposed trench. Lay pipe or other utility line and bury as soon as possible after trenching.
- After installation is complete (or at the end of work day, if installation cannot be completed by end of day), install silt fencing along trench line on either side of creek at 25-ft intervals, as shown in Figure 3-31.
- Material excavated from the trench in the creek channel should not be deposited on the channel banks. Excavation should be hauled out of the channel or used in

backfill of open trench. No loose excavated material should be left in the channel at the end of a work day.

- A concrete cap should be placed over buried pipe within the creek, and the streambed should be restored to proper grade.
- Revegetate the disturbed area using appropriate native or adapted grass species incorporated with erosion blankets/matting.

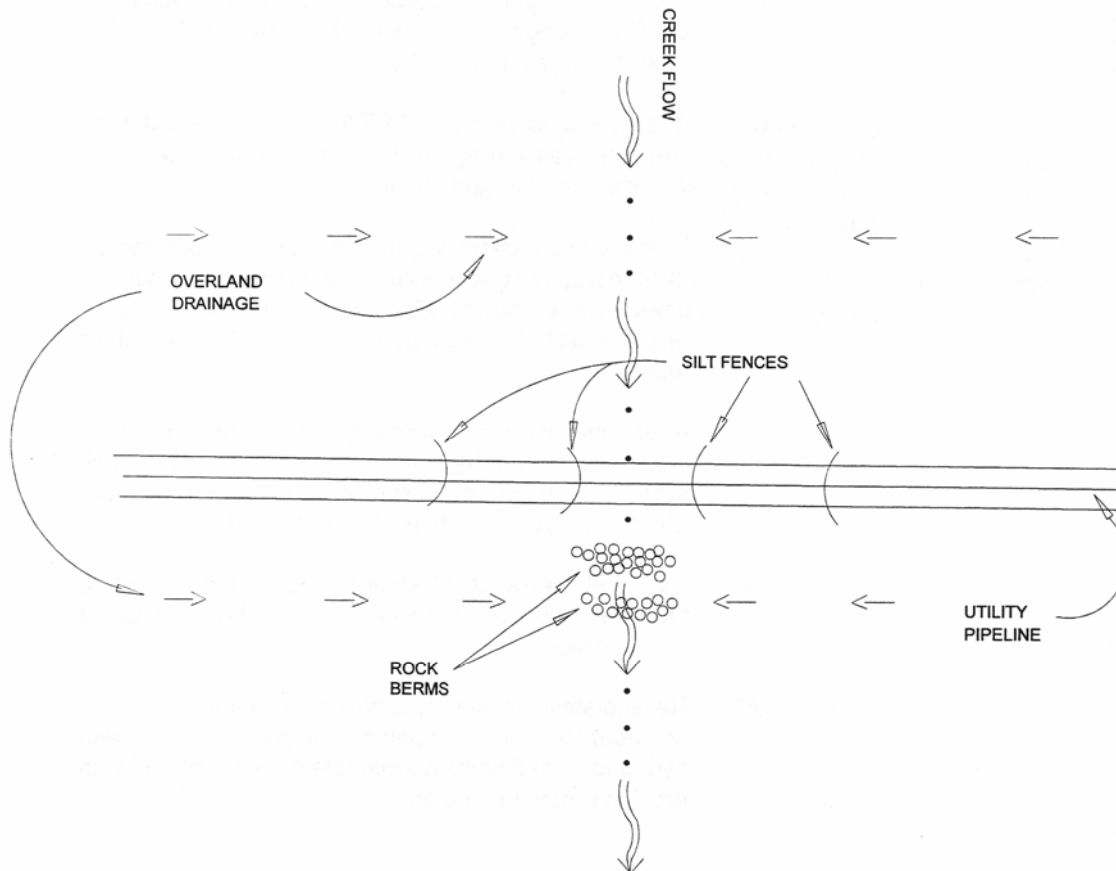

Figure 3-31 Utility Crossing or Excavation within Creek

Road Crossings

A variety of techniques may be used depending on local topography and soil conditions. These include ford crossings, culvert crossings, dragline mats, and bridges.

General Considerations

- Construct temporary crossings at proposed roadway crossings and any additional crossing points. Minimize the number of additional crossings to reduce impact to creeks.
- Where a stream crossing is required, select a crossing site with these features:
 1. Straight and narrow creek channel with high banks;
 2. Stable creek banks that provide solid foundation for a crossing.
 3. Minimal elevation changes (0-10% preferred) on road/trail leading to crossing.

Installation

- Keep heavy equipment out of creek.
- Construct a swale or berm across the approach to the crossing on both sides of the crossing. Other water diversion devices (broad based dips, water bars, etc.) should be used on long approaches to minimize the amount of water flowing to the crossing).
- Stabilize exposed soil around the crossing with mulch, temporary seeding and/or erosion control blankets/matting.

Maintenance

- Keep crossing surface free of soil and debris that could enter stream.
- Check crossing components weekly and after rainfall to maintain strength and integrity.
- Remove large branches or other flow obstructions that could impair the function of the crossing or cause a failure of the crossing.

Removal & Restoration

- Clean off crossing surface; keep debris out the creek channel.
- Carefully remove crossing materials, minimizing disturbance to the creek channel.
- Permanently stabilize disturbed portions of creek bank and approaches with perennial grasses, erosion control blankets/matting and/or rip rap
- Leave appropriate water diversion structures in place on both sides of creek.

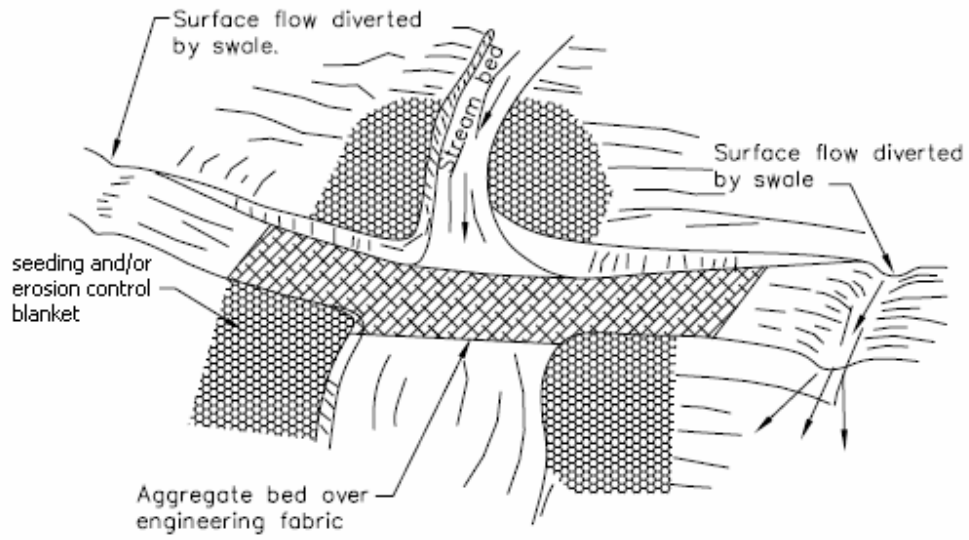

Aggregate approach
1:5 (V:H) Maximum slope on road

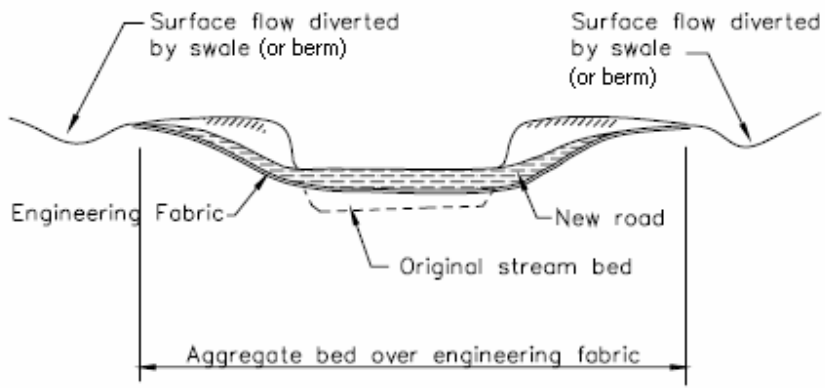

TYPICAL FORD CROSSING
NOT TO SCALE

Figure 3-32 Typical Temporary Ford Crossing

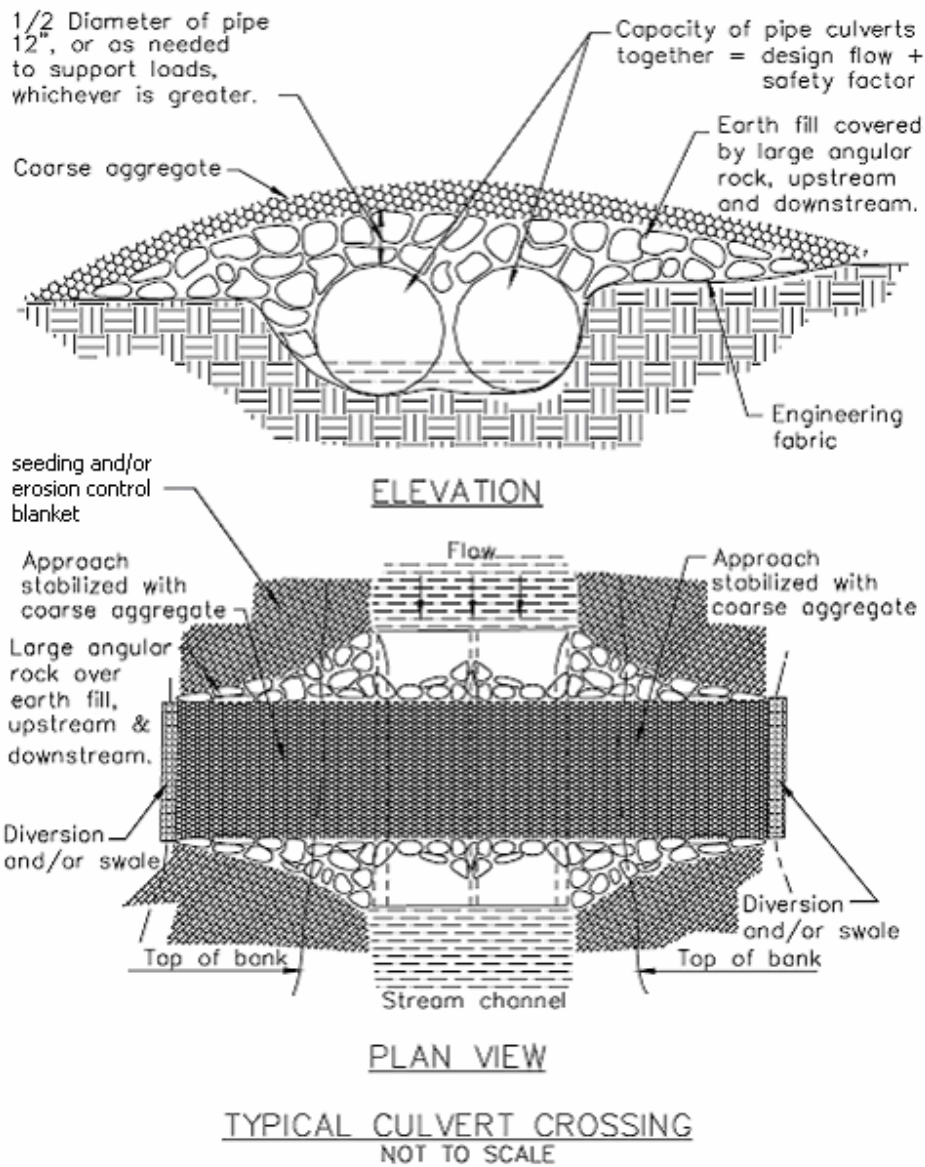
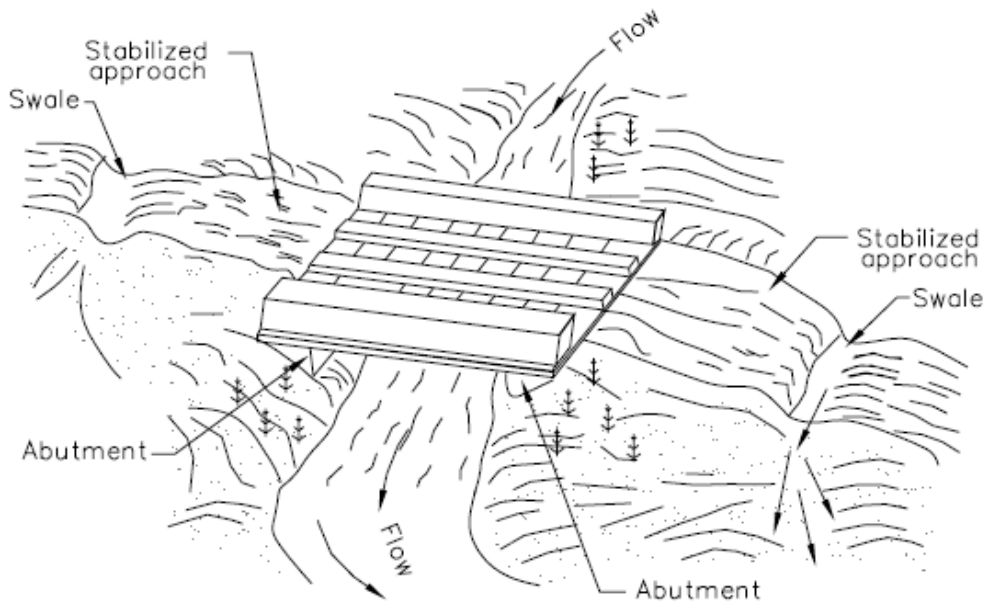

Figure 3-33 Typical Temporary Culvert Crossing



NOTE:
Surface flow of road diverted
by swale and/or dike.

TYPICAL BRIDGE CROSSING
NOT TO SCALE

Figure 3-34 Typical Temporary Bridge Crossing

3.3.17 Concrete Washout Areas

The purpose of concrete washout areas is to prevent or reduce the discharge of pollutants to stormwater from concrete waste by conducting washout offsite, performing onsite washout in a designated area, and training employees and subcontractors.

The following steps will help reduce stormwater pollution from concrete wastes:

- Incorporate requirements for concrete waste management into material supplier and subcontractor agreements.
- Avoid mixing excess amounts of fresh concrete.
- Perform washout of concrete trucks in designated areas only.
- Do not wash out concrete trucks into storm drains, open ditches, streets, or streams.
- Do not allow excess concrete to be dumped onsite, except in designated areas.

For onsite washout:

- Locate washout area at least 50 feet from sensitive features, storm drains, open ditches, or water bodies. Do not allow runoff from this area by constructing a temporary pit or bermed area large enough for liquid and solid waste.
- Wash out wastes into the temporary pit where the concrete can set, be broken up, and then disposed properly.

Below grade concrete washout facilities are typical. These consist of a lined excavation sufficiently large to hold expected volume of washout material. Above grade facilities are used if excavation is not practical. Temporary concrete washout facility (type above grade) should be constructed as shown on the details at the end of this section, with sufficient quantity and volume to contain all liquid and concrete waste generated by washout operations. Plastic lining material should be a minimum of 10 mil in polyethylene sheeting and should be free of holes, tears, or other defects that compromise the impermeability of the material.

When temporary concrete washout facilities are no longer required for the work, the hardened concrete should be removed and disposed of. Materials used to construct temporary concrete washout facilities should be removed from the site of the work and disposed of. Holes, depressions or other ground disturbance caused by the removal of the temporary concrete washout facilities should be backfilled and repaired.

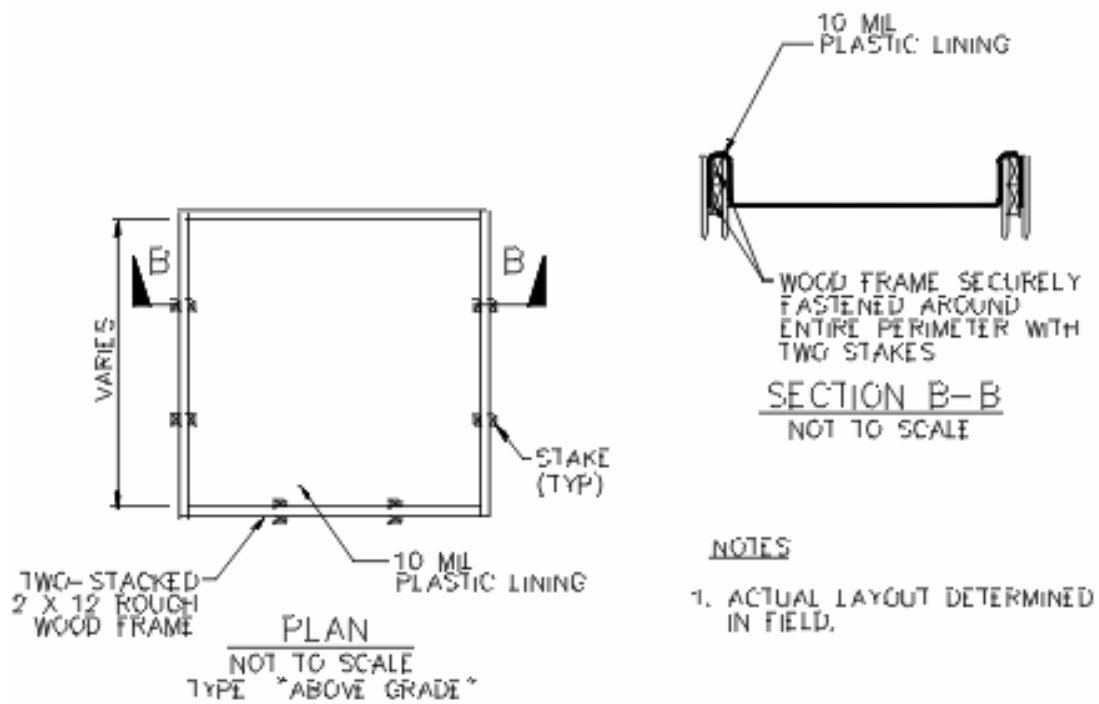
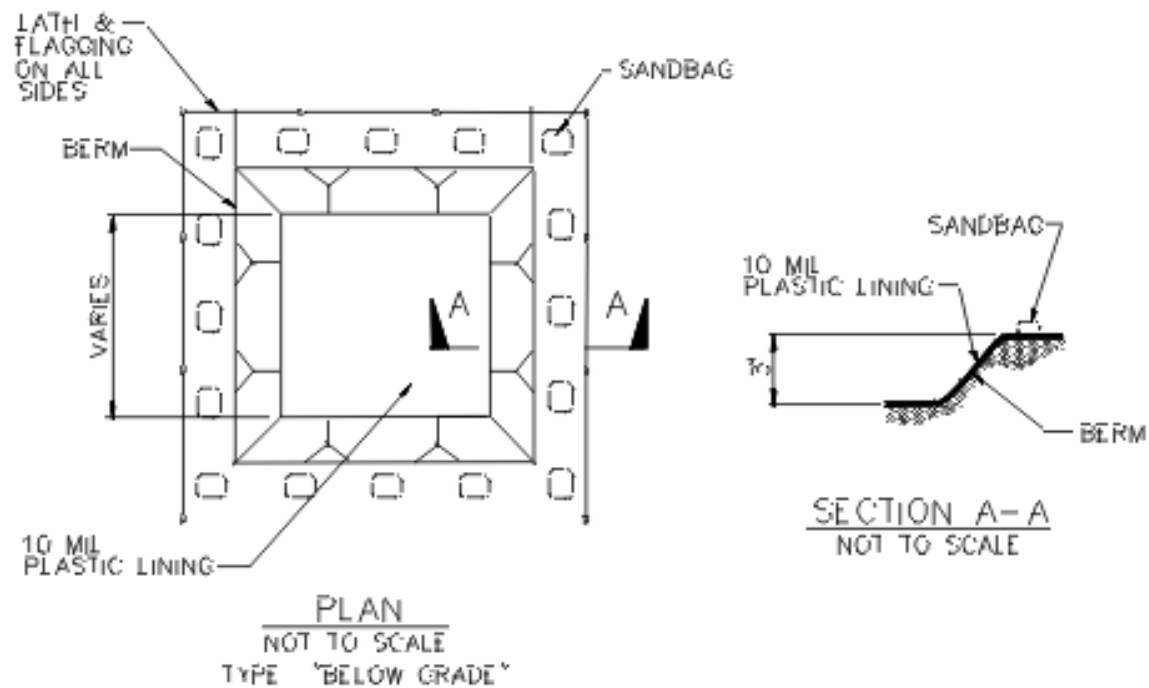

Figure 3-35 Schematic Diagrams of Concrete Washout Areas

Chapter 4 – Development Activity

Permanent Water Quality Treatment Best Management Practices

4.1 Introduction

Permanent water quality treatment best management practices (BMPs) are those measures that are used to control pollution from regulated activities after construction is complete. In the Highland Lakes Watershed Ordinance (HLWO), permanent treatment BMPs are implemented to reduce pollution of surface water or stormwater that originates on site or up-gradient from the site. This Chapter provides technical guidance for the design and construction of water quality treatment BMPs. Best management practices designed per Chapter 2 and this Chapter will manage 70% of the average annual post development total phosphorus, total suspended solids, and oil and grease loads.

The intent of the HLWO is to mimic existing hydrologic conditions through total site design techniques and rely less on the use of water quality basins, which are designed to capture, detain and treat the water quality volume calculated in Chapter 2.3. Alternate Standards are available for development with a gross impervious cover less than 15% and commercial projects less than three (3) acres in area when the development complies with the conditions in this manual. Compliance with Alternate Standards eliminates the need for construction of water quality basins. For projects in excess of the alternative compliance impervious cover limits, stormwater credits per Chapter 2.3.2 can be used to more closely mimic existing hydrologic conditions and thus reduce the calculated impervious cover and the water quality volume.

In the event that water quality basins cannot be avoided through total site design planning or compliance with the Alternate Standards, then a water quality basin can be selected from Chapter 2.3.3 and designed per this Chapter.

Based on project experience and research, **LCRA recommends the use of three BMP suites that provide optimum stormwater treatment at the lowest cost and with the smallest footprint; 1) extended detention basin in combination with an infiltration trench and vegetated filter strip, 2) extended detention basin in combination with a bioretention pond, and 3) conservation landscaping as an up-gradient BMP with any water quality basin.** Approaches one and two above rely on settling within the extended detention basin and infiltration in the trench or bioretention basin to manage the targeted pollutants. Option 3 relies on conservation landscaping practices to limit nutrient and chemical application at the source, then utilize the water quality basin to further treat runoff. As shown on Table 2-5, extended detention basins have the lowest cost when compared to other basins, can be constructed on-line or off-line, can accommodate a wide range of drainage areas, can include flood control as well, require minimal maintenance, can be effectively landscaped, and experience limited liability and safety issues. The extended detention BMP is detailed in 4.3.2.

Permanent water quality treatment BMPs not included in this Chapter may be used with permission of the LCRA based on objective performance monitoring studies.

4.2 *Water Quality Treatment BMP Guidelines*

This section provides guidelines for developments that will not meet the alternative compliance conditions of the Highland Lakes Watershed Ordinance (HLWO) and therefore will require at the minimum either vegetative filter strips and/or water quality basin BMPs.

Water quality basins presented in this section include bioretention, extended detention, sand filter, retention/irrigation and wet basins and are considered primary BMPs. The basins are sized to detain the water quality volume calculated in Chapter 2.3. This water quality volume is based on procedures which determine the runoff volume from the 1-year design storm for a contributing drainage area (Refer to Equations 2.9 and 2.10). The water quality basins provide either the total or the bulk of the required pollutant removal and may require secondary water quality treatment in the form of vegetative filter strips and infiltration devices. Vegetative filter strips presented in this section include natural, engineered, and infiltration filter strips while infiltration devices presented include infiltration basins and trenches.

4.2.1 General Design Guidelines

The following general guidelines apply to all permanent BMPs in this section.

- (1) *Siting Requirements:*
 - i. All water quality basins must lie outside the Creek Buffer Zone; and
 - ii. All permanent BMPs receiving off-site runoff or serving a single-family subdivision should be shown within a drainage easement or conservation easement. Vegetative Filter Strips may be shown within the building set back of a lot in lieu of being located in a drainage easement. The easement or building setback must include appropriate restrictions regarding the amount and type of improvements that may be constructed.
- (2) *Safety Considerations:*
 - i. *Embankment Safety:* The design should direct grading to avoid drop-offs and other hazards. Side slopes of basins should be 3:1 (H:V) or flatter for grass stabilized slopes. Slopes steeper than 3:1 (H:V) must be stabilized with an appropriate slope stabilization practice;
 - ii. *Dam Safety:* See Section 299 of the TCEQ rules on Dams and Reservoirs for dam safety requirements. These rules apply to any barriers, including one for flood detention or water quality management, designed to impound liquid volumes and which has a dam height greater than six feet;
 - iii. *Hazardous Materials:* For developments that store or dispense hazardous materials a valve should be installed so that discharge from the BMP can be stopped in case runoff from a spill of hazardous material enters the

basin. The control for the valve must be accessible at all times, including when the basin is full; and

- iv. *Limit Access:* Fencing, landscaping and curb stops can be used to impede access to a facility. The primary spillway opening must not permit access by small children. If the facility is fenced, gates must be provided to allow access for inspections and maintenance.
- (3) *Stabilization Requirement:* A plan should be provided indicating how disturbed areas will be stabilized and re-vegetated. Revegetation must follow the guidelines in Chapter 3 and begin within 14 days of the end of construction activities. Erosion control must be provided to protect exposed soil on slopes greater than 3:1 and can be provided in the form of sod, matting, straw or other approved means.
- (4) *Vegetation Requirements:* The vegetation density for all permanent BMPs must be greater than 80% with no large bare areas. The filter area should be densely vegetated with a mix of erosion-resistant plant species that effectively bind the soil. Native or adapted grasses, shrubs, and trees are appropriate because they generally require less fertilizer and are more drought resistant than exotic plants. Turf grass (vegetated filter strips) should be mowed to maintain a grass height of no more than 4-inches to keep the grass in an active growth phase. Permanent BMP areas should be managed to minimize or avoid the application of fertilizers, pesticides, or herbicides.

The following wet tolerant species are recommended for planting within areas that experience frequent inundation:

<u>Ground Cover</u>	<u>Trees</u>	<u>Shrubs</u>
- Bushy bluestem	- Bald cypress	- American beauty berry
- Sedges	- Pecan	- Cherry Laurel
- Cyperus	- Sycamore	- Possumhaw holly
- Switch grass	- Texas ash	- Butterfly bush
- Spike rush		- Coral berry
- Green sprangletop		- Palmetto
- Indian grass		- Obedient plant (fall)
- Bullrush		
- Scouring rush		
- Eastern gamma		
- Dropseed iris		
- Muhly		
- Bermuda grass (high performer in dry and during extended wet periods)		

- (5) *Construction-phase runoff:* Basins may be used as sediment basins during construction. Embankments and conveyances must be properly compacted with an emergency overflow outlet. Basins must have sediment accumulations removed, final grades restored and stabilization achieved prior to completion.

No portion of a basin using infiltration or filtration shall be used to collect or treat construction-phase runoff. No runoff shall be received by these facilities until site is completely stabilized.

- (6) *Maintenance Requirements:* Provide adequate maintenance access to all permanent BMP inlet and outlet structures, filtration and sedimentation areas. A fixed vertical sediment depth marker should be installed in the bottom of sedimentation areas to determine when sediment accumulation has exceeded limits set in the maintenance plan. See Chapter 5 for Maintenance Plan requirements for all permanent BMPs.
- (7) *Basin Inflow:*
 - i. *Energy dissipation:* Is necessary where concentrated flow enters a basin to distribute inflow uniformly and at low velocities to avoid scour to promote sedimentation. This can be accomplished by following the guidelines in Chapter 3.2.5 for Outlet Stabilization, which provides design information for rock riprap aprons;
 - ii. *Off-line Design:* When siting a water quality basin to intercept drainage, the designer should attempt to use the preferred “off-line” facility design. Off-line facilities are defined by the flow path through the facility. Any facility that utilizes the same entrance and exit flow path upon reaching pooling capacity is considered an off-line facility. Keep in mind that off-line design can be used to bypass the off-site drainage area to avoid sizing the basin for the entire contributing drainage area, see Page 2-9 “Step 2: Determine Drainage Area to BMP” for details;
 - iii. *Flow Splitting Device:* When the pond is designed as an off-line facility, a splitter structure is used to isolate the water quality volume. The splitter box, or other flow diverting approach, should be designed to convey the 25-year storm event while providing at least 4-inches of freeboard between the top of the basin walls or embankment and the 25-year water surface elevation; and
 - iv. *Sediment Forebay:* A forebay serves as a pretreatment device that consists of a separate cell sized to detain 25% of the design water quality volume to retain the first flush runoff volume. All storm sewer runoff shall enter a sediment forebay and include energy dissipation devices at their outfalls. Exit velocities from the forebay should not be erosive. A low flow channel should be provided through the sediment forebay if erosive velocities are present. The channel should be stabilized and permeable, not concrete.
- (8) *Basin Outflow:* Design drawdown time of 48 hours for the water quality volume.
 - i. *Energy dissipation:* Is necessary where concentrated flows discharge from a basin to prevent erosion and scour. Energy dissipation can be

accomplished by following the guidelines in Chapter 3.2.5 for Outlet Stabilization, which provides design information for rock riprap aprons;

- ii. *Spillways*: For online basins, the basin must convey the developed 25-year storm event from the contributing drainage area with at least 4-inches of freeboard between the top of the basin walls or embankment and the 25-year water surface elevation;
- iii. *Flow Spreading Device*: Flow spreading of concentrated outflows from water quality basins, flow splitting devices and spillways are required to convert runoff from the 1-yr, 3-hr storm event under fully-developed conditions to sheet flow prior to the buffer zone. Sheet flow is defined to have a flow depth less than 0.2 feet and a velocity of less than one (1) feet per second. The following equation based on the Continuity Equation can be used to determine the required flow spreader length.

Continuity Equation

$$Q = V * A$$

where:

$Q_{1\text{-year dev}}$ = peak flow rate from the 1-yr, 3-hr storm event (cfs) (Refer to design spreadsheet)

$V < 1$ fps for sheet flow conditions

$A = L * H$ where $H < 0.2$ feet for sheet flow conditions (square feet)

L = minimum required length of flow spreader (ft)

$$L \text{ (feet)} = 5 * Q_{1\text{year dev}}$$

Refer to Chapter 3.2.6 for design guidelines for a flowspreader device. Alternative flow spreader devices can be used as long as the sheet flow requirements above are met for the 1-yr, 3-hr storm event.

- iv. *Tailwater Conditions*: The 25-year hydraulic gradient of receiving waterways, ditches, and storm-sewers should be considered in the design of water quality basin outlets. Particularly back flow of receiving waterways into water quality basins should be prevented; and
- v. *Underdrain Piping*: The underdrain piping should have a minimum diameter of 6" and a minimum slope of 0.5%. The piping should have perforated slots or holes small enough so the surrounding gravel doesn't pass through the perforations (typical. $< 3/8$ " diameter.) and a maximum spacing between rows of perforations of less than 6 inches. Each individual underdrain pipe should have a cleanout access location that is flush with the ground surface and located outside the basin floor on the basin side slope to minimize damage during maintenance.

The underdrain is wrapped in a gravel jacket. A minimum of 2 inches of clean, washed $1/2$ to $1-1/2$ " clean aggregate with no fines (river gravel)

must be placed over and below the underdrain PVC pipe. A non-woven 4oz./sy or heavier geotextile fabric is required to separate the river gravel from the adjacent soil.

4.2.2 Bioretention Basin

Description

The bioretention water quality basin functions as a soil and plant-based filtration device that removes pollutants through a variety of physical, biological, and chemical treatment processes. Bioretention basins normally consist of a grass buffer strip, infiltration bed, ponding area, organic or mulch layer, planting soil, and plants. Filtration of the stored water into the underlying soils occurs over a period of two days. The vegetation not only enhances aesthetics but promotes nutrient uptake and evapotranspiration. Bioretention provides additional pollutant removal over a system that uses sedimentation and filtration only. A schematic of a bioretention basin is presented in Figure 4-1. Rain gardens, an on-lot version of bioretention are detailed in Appendix 2.10.2.

Application

A bioretention basin can be used as a stand alone BMP in the Highland Lakes Watershed Ordinance and does not require secondary treatment. A bioretention BMP is a good choice for an onsite system serving a relatively small drainage area where the basin landscaping can be incorporated into the site providing attractive benefits such as an aesthetic feature, shade, wind breaks, and noise absorption. As with any BMP that is designed to pond water, careful selection and control of materials is imperative to ensure adequate drainage.

A bioretention basin can also be placed downgradient of an extended detention, sand filter, or a wet basin to provide secondary treatment. A bioretention basin used in this manner is only required to detain a small fraction of the required water quality volume as shown in Table 2-9.

Design Guidelines

- (1) *Contributing Drainage Area:* A maximum contributing drainage area of 3 acres is recommended when runoff enters a basin via sheet flow and a maximum contributing drainage area of 10 acres is recommended when runoff enters a basin via concentrated flow.
- (2) *Pre-treatment:* A sediment forebay is required if runoff entering the basin is concentrated (i.e. end-of-pipe treatment). Refer to the design guidelines for a Sediment Forebays in General Guidelines Item No. 7.

A forebay is not required if basin receives runoff via sheet flow. If pond receives runoff in a sheet flow manner pre-treatment in the form of a Vegetated Filter Strip or a hedgerow is recommended but not required.

- (3) *Soil Requirements:* Greater than three (3) feet between the high water table and the BMP invert and greater than 1 foot between bedrock and the BMP invert. The BMP invert is defined as the bottom of the soil media. Infiltration rates less than 1 inch per hour require underdrain piping. At least one soil boring or test hole per 5,000 square feet is necessary to characterize the soil, water table, and bedrock depth. The infiltration rate should be determined using one of the following:

(a) Infiltrometer testing using a double ring infiltrometer (ASTM D 3385-94) or percolation test.

- (4) *Basin Sizing:* The BMP Volume for a basin providing primary treatment is calculated by applying a factor of 1.05 to the Water Quality Volume (WQV) calculated per Chapter 2.3. The WQV is increased by a factor of 5% to accommodate for the reduction in the available storage volume due to deposition of solids in the time between full-scale maintenance activities.

BMP Volume = WQV * 1.05 (primary treatment)

BMP Volume = WQV * 0.044 (secondary treatment downgradient of extended detention basin)

BMP Volume = WQV * 0.033 (secondary treatment downgradient of sand filter)

BMP Volume = WQV * 0.029 (secondary treatment downgradient of wet basin)

WQV = Required Water Quality Volume as calculated in Chapter 2.3 (cubic feet), through the use of equations 2-9 and 2-10.

- (5) *Basin Configuration:* The basin shape is flexible and can be designed to accommodate site conditions. The footprint of the soil mixture media should be sufficiently large that it underlies the entire flooded area for the design water quality volume. The floor of the basin should be graded as flat as possible to permit uniform ponding and infiltration. Low spots and depressions should be leveled out.
- (6) *Basin Depth:* The water depth over the soil mixture (filtration media) for the design storm should not exceed 12" unless a sand filter overflow is included in the design. The use of a sand filter allows a water depth of 24" over the soil mixture media and 12" over the sand filter.
- (7) *Filtration Media:* Minimum thickness of 30" with 18-24" of soil mixture over 6-12" of sand. The soil mixture should be 30-40% sand or granite sand and 50-60% topsoil and 10% peat. The soil mix should have less than 5% clay with no commercial fertilizers, manure, or sandy loam. Provide clean sand, free of deleterious materials. Sand should be ASTM C-33 with grain size of 0.02-0.04 inches (same as sand filter). The soil should be a uniform mix, free of stones, stumps, roots, or other similar objects larger than one inch. No other materials or substances should be mixed or dumped within the bioretention that may be

harmful to plant growth, or prove a hindrance to the planting or maintenance operations. The planting soil shall be free of noxious weeds.

Minimum infiltration rate = 0.25 inches per hour.

Installation of soils must be done in a manner that will ensure adequate filtration. Place soil at 8-12" lifts after scarifying the invert area of the proposed facility. Lifts are not to be compacted but are placed in order to reduce the possibility of excessive settlement. Lifts may be lightly watered to encourage natural compaction. Avoid over compaction by allowing time for natural compaction and settlement. No additional manual compaction of soil is necessary. Rake soil material as needed to level out. Overfill above the proposed surface invert to accommodate natural settlement to proper grade. Depending upon the soil material, up to 20% natural compaction may occur.

- (8) *Sand Filter Overflow*: Optional feature which provides a sand filter overflow 12" above the soil mixture media which allows for a total ponding depth of 24" above the soil mixture media. The area of sand filter overflow is sized per the sand filter basin criteria ($\text{Area} = \text{WQV}/18$). Minimum thickness of 18" and a 2"-3" topsoil cover of at least 30-40% sand may be placed over the sand filter to provide for a vegetated cover. The sand filter overflow area must be separated from the soil mixture media by an impermeable wall.
- (9) *Underdrain*: An underdrain is required in all designs where soil infiltration rates are less than one-inch per hour. See General Requirements Item No. 8 for more information. When an underdrain is used, an orifice is installed in the drain line to ensure that the pond drawdown is not less than 48 hours. Minimum orifice size shall be 1" in diameter.
- (10) *Vegetation Requirements*:

Basic guidelines for planting in a bioretention area include:

- i. Overall vegetation density must be greater than 80% with no large bare areas;
- ii. Provide multiple plant species in order to increase the chances of the development of viable ground cover and vegetated area per 4.2.1 (4). Include a minimum of three species each of trees and shrubs and plant 2-3 shrubs for each tree. Provide one large tree and three shrubs or two small trees and three shrubs per 5,000 square feet;
- iii. Native vegetation is recommended, selected for tolerance to ponding and dry soil conditions, again relying on 4.2.1 (4);
- iv. Typically use a shredded hardwood mulch layer over exposed soil around plants;
- v. Locate plant material near the perimeter but not at the inflow other than dense grasses that may serve to dissipate flows.

- vi. A hedge row of Big Muhly or equivalent plant is recommended to evenly spread concentrated flow at the inflow over the basin floor; and
- vii. A one-year vegetation warranty is required on all plants and trees.

BASIN SIZING

$BMP\ VOL. = WQV * 1.05$

EXAMPLE ON-LINE BIO-RETENTION POND

CONTRIBUTING DRAINAGE AREA = 1 ACRES @ 70%

WQV = 4,501 CF

$BMP\ VOL. = WQV * 1.05 = 4,726\ CF$

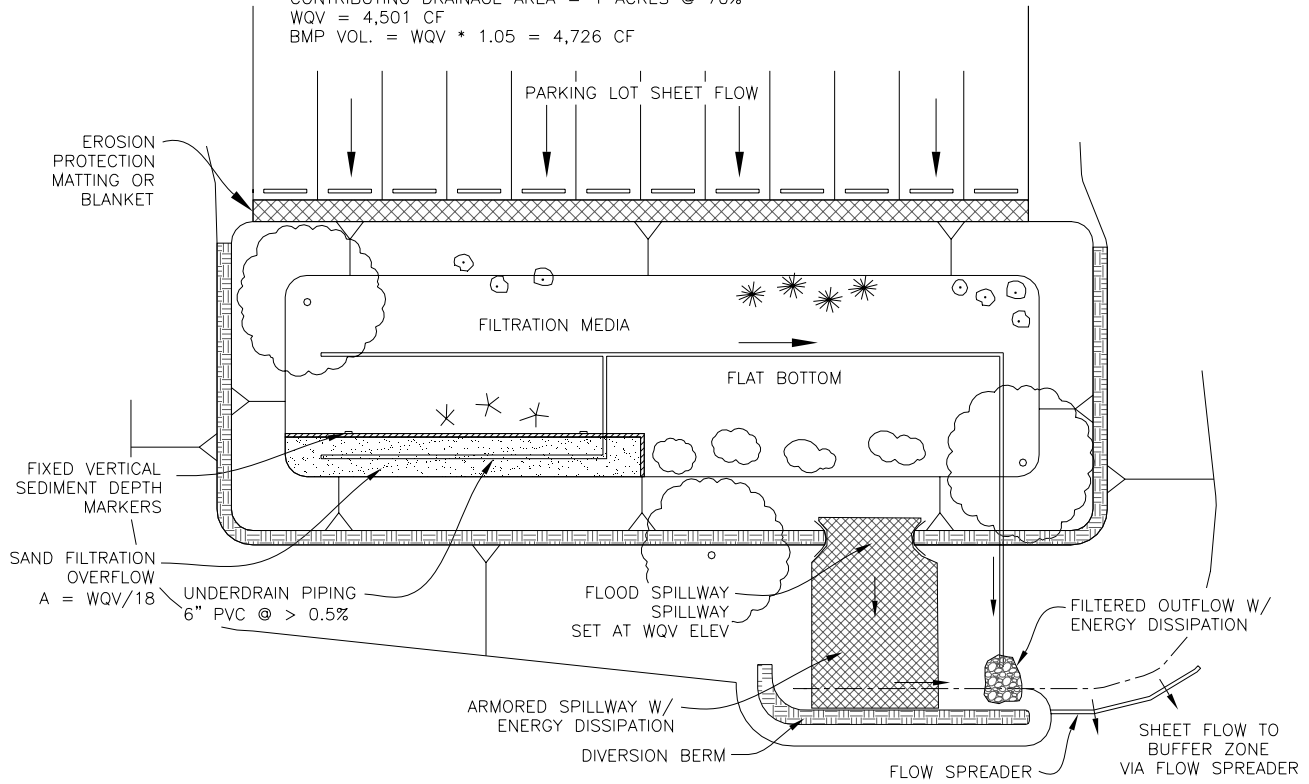

PLAN VIEW

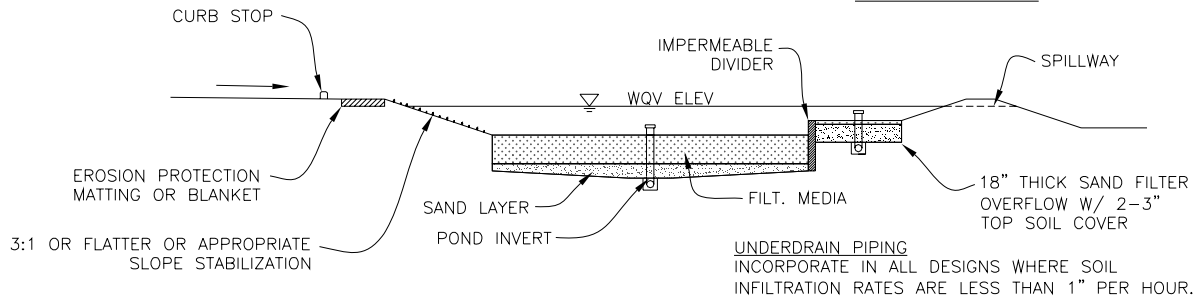

POND SECTION

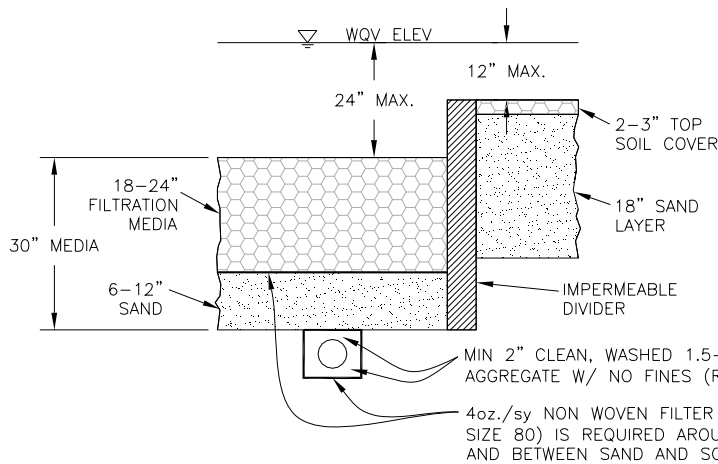

FILTRATION MEDIA

- 30-40% SAND
- 50-60% TOPSOIL
- 10% PEAT MOSS
- SOIL MIX <5% CLAY, NO COMMERCIAL FERTILIZER, MANURE OR SANDY LOAM
- INFILTRATION RATE OF AT LEAST 0.25 IN/HR

SAND

GRAIN SIZE 0.02-0.04"

UNIFORM MIX, FREE OF STONES, STUMPS, ROOTS, OR OTHER SIMILAR OBJECTS LARGER THAN 2"

MEDIA PROFILE

Figure 4-1: Bioretention Basin with Sand Filter Overflow Schematic

4.2.3 Extended Detention Basin

Description

Extended detention basins capture and temporarily detain the water quality volume. They are intended to serve primarily as settling basins for the solids fraction, nutrients attached to solids, and as a means of limiting downstream erosion by managing stormwater. Extended detention basins may be constructed either online or offline. Extended detention basins are typically depressed basins that temporarily store stormwater runoff following a storm event and do not have a permanent water pool between storm events. Water is controlled by means of a hydraulic control structure to restrict outlet discharge.

The water quality benefits are the removal of sediment and buoyant materials. Furthermore, nutrients, heavy metals, toxic materials, and oxygen-demanding materials associated with the particles are also removed. The control of the maximum runoff rates serves to protect drainage channels below the device from erosion and to reduce downstream flooding. Refer to Figure 4-2 for a schematic of an extended detention basin.

Application

An extended detention basin cannot be used as a stand alone BMP to obtain compliance with the Highland Lakes Watershed Ordinance and requires secondary treatment in the form of vegetative filter strips, an infiltration basin/trench or a bioretention basin.

One of the main advantages of extended detention basins is their adaptability; they can be used on areas with thin soils, high evaporation rates, low-soil infiltration rates, in limited-space areas, and where groundwater is to be protected. Due to the simplicity of design, extended detention basins are relatively easy and inexpensive to construct and operate. Extended detention basins are generally best suited to drainage areas greater than three acres, since the outlet orifice becomes prone to clogging for small water quality volumes. Also extended detention basins can readily be combined with flood control detention facilities by providing additional storage above the water quality volume.

Design Guidelines

- (1) *Contributing Drainage Area:* Less than 128 acres recommended, no minimum drainage area.
- (2) *Pre-treatment:* A sediment forebay is designed to retain the bulk of the sediment entering the facility. This will simplify sediment removal and reduce overall basin maintenance. Refer to the design guidelines for sediment forebays in General Guidelines Item No. 7, where the forebay volume is equal to 25% of the water quality volume to retain the first flush runoff volume. To promote advanced treatment of the first flush volume, the forebay design relies on a berm and/or gabion within the basin to promote pollutant settling. Non woven filter fabric with a **0.15 mm** (U.S. Sieve Size 100) opening shall be placed on the gabion to enhance detention and facilitate maintenance. Rock rip rap shall be placed on the downstream side to prevent scouring in the event flow passes over the gabion. Use guidance found in 3.2.4 and 3.2.5.

- (3) *Secondary Treatment:* Extended detention ponds require secondary treatment either before or after the pond in the form a vegetative filter strip, an infiltration basin/trench, or a bioretention basin. See Table 2-9 for design guidance.

Up-gradient

Natural Vegetative Filter Strip	WQV* 1.05
Engineered Vegetative Filter Strip	WQV* 0.53
Vegetative Infiltration Strip	WQV* 0.35

Down-gradient

Natural Vegetative Filter Strip	WQV* 0.4
Engineered Vegetative Filter Strip	WQV* 0.2
Vegetative Infiltration Strip	WQV* 0.13
Infiltration Basin	WQV* 0.058
Infiltration Trench (Void)	WQV* 0.03
Infiltration Trench (length) + VFS*	WQV* 0.006 (see below for VFS requirements)
Bioretention Basin	WQV* 0.044

WQV = Required Water Quality Volume as calculated in Chapter 2.3 (cubic feet)

When the infiltration trench option is used, it also serves as a flow spreader. Optimal pollutant removal within a limited BMP footprint is provided when the extended detention basin is used in combination with an infiltration trench and vegetated filter strip.

* The vegetated filter strip must be located up-gradient of the buffer zone and be at least 15 feet in width if an engineered filter strip is proposed and at least 30 feet in width if a natural filter strip is used. In addition, follow the guidance in 4.2.7, Vegetative Filter Strips.

- (4) *Basin Sizing:* The BMP Volume is calculated by applying a factor of 1.05 to the Water Quality Volume (WQV) calculated per Chapter 2.3. The WQV is increased by a factor of 5% to accommodate for the reduction in the available storage volume due to deposition of solids in the time between full-scale maintenance activities.

$$\text{BMP Volume} = \text{WQV} * 1.05$$

WQV = Required Water Quality Volume as calculated in Chapter 2.3 (cubic feet)

- (5) *Basin Configuration:* The extended detention basin is optimally designed to have a gradual expansion from the inlet toward the middle of the facility and a gradual contraction toward the basin outfall. The ratio of flow-path length to width from the inlet to the outlet should be at least 2:1 (L:W). The flow-path length is defined as the distance from the inlet to the outlet as measured at the surface. The width is defined as the mean width of the basin. Higher length-to-width ratios are recommended. Outlets should be placed to maximize the flow-path through the facility. The basin should maintain a longitudinal slope between 1.0 – 5.0% with a lateral slope between 1.0 – 1.5%. See Figure 4.2 for guidance.
- (6) *Basin Depth:* The water depth in the basin when full should be no greater than 8 feet.

- (7) *Basin Outlet:* The facility's drawdown time should be regulated by an orifice plate located downstream of the primary outflow opening. The outflow structure should be sized to allow for complete drawdown of the water quality volume within 48 hours. In addition, the outlet shall be configured to provide at least 12-hour detention for 0.5 inches of runoff from the total effective impervious cover. The minimum orifice diameter is 1-inch. Non woven filter fabric with a minimum opening of **0.15 mm** (U.S. Sieve Size 100) shall be wrapped around the riser to enhance detention. The riser should be double-wrapped with filter fabric until the contributing drainage area is vegetated and stabilized. The outflow structure must have a trash rack or other acceptable means of preventing clogging at the entrance to the outflow pipes. Refer to Figure 4-4 for a detail of a typical riser pipe. The following equation can be used to determine the required orifice size:

$$A_o = \frac{0.001BMP_Vol.}{C\sqrt{2gH_{avg}}}$$

A_o = maximum orifice area (square inches)

$BMP\ Vol.$ = required basin volume as calculated above (cubic feet)

C = orifice coefficient (Typical. 0.62)

g = acceleration of gravity (32.2 ft/s²)

H_{avg} = $H_T/2$, average hydraulic head (ft)

H_T = total hydraulic head determined from difference between the WQ elev. and the center of orifice

- (8) *Basin Soils:* To enhance infiltration and water storage within the basin, topsoil must be placed on the basin floor after excavated bottom is scarified to a depth of 2 to 3 inches to improve drainage. The topsoil must be 6 to 8 inches deep and a soil mixture of 30-40% sand or granite sand, 60-70% topsoil, and suggest 5-10% compost or peat to aid water retention and promote vegetation growth. Soil blend must have clay content less than 20 percent and be free of stones, stumps, roots or other similar objects larger than one (1) inch. If on-site soils do not meet these specifications, topsoil per the above specs must be added. Sandy loam is not an approved soil and caliche is not considered a soil.
- (9) *Vegetation –* To enhance appearance and function, trees and shrubs, and vegetation are recommended along with Bermuda grass coverage (strongly recommend sod). Refer to bioretention basin vegetation requirements (4.2.2 (10)) for guidance. Muhly can be used to aid in spreading flow and concealing the riser pipe and mid-basin gabion. In addition, trees and shrubs can effectively screen other structural aspects and will aid in evapotranspiration and basin floor drying.

NOTES:

- * ED BASIN MUST BE LOCATED OUTSIDE BUFFER ZONE
- * CONTRIBUTING DRAINAGE AREA < 128 AC
- * PRE-TREATMENT RO'D IN FORM OF SEDIMENT FOREBAY
- * SECONDARY TREATMENT REQUIRED BEFORE OR AFTER POND
- * $BMP\ VOL. = 1.05 * WQV$
- * AT LEAST 2:1 LENGTH TO WIDTH RATIO
- * SECONDARY TREATMENT REQUIRED
- (SEE TABLE 2-9 FOR SECONDARY BMP SIZING GUIDELINES)

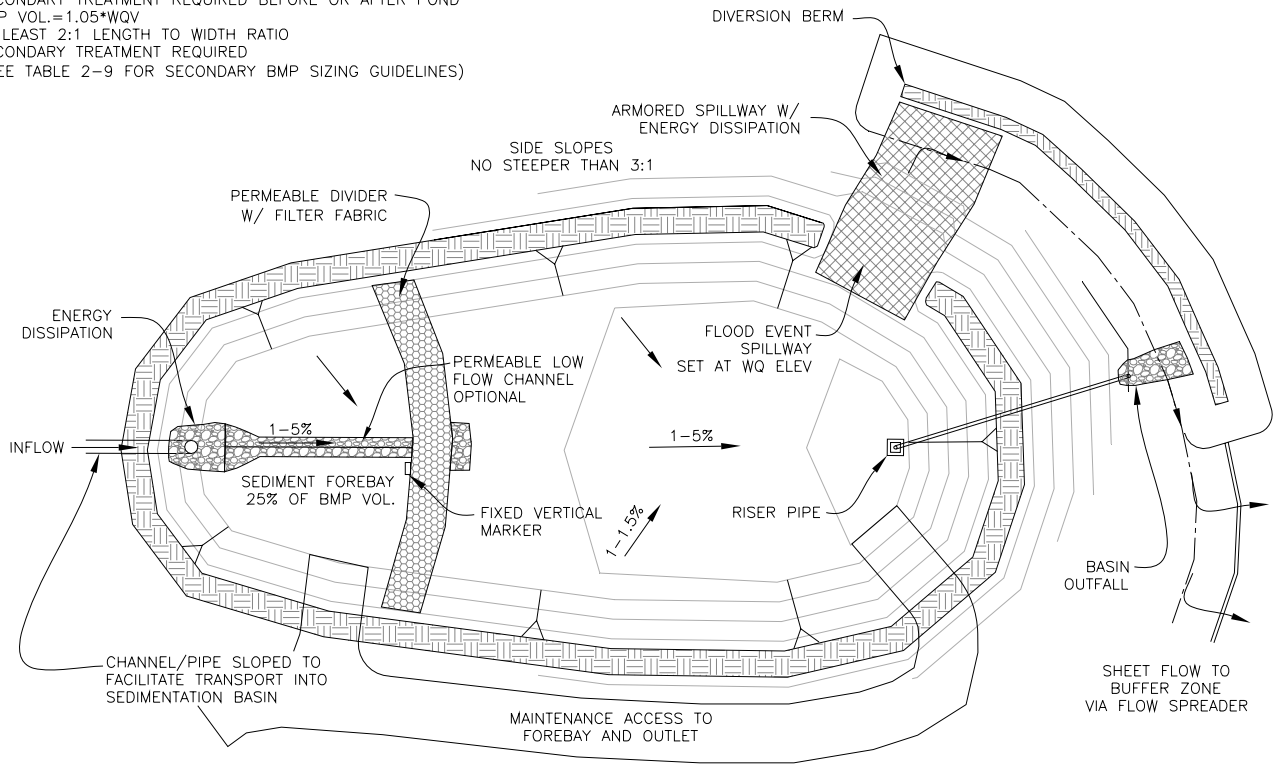

PLAN VIEW

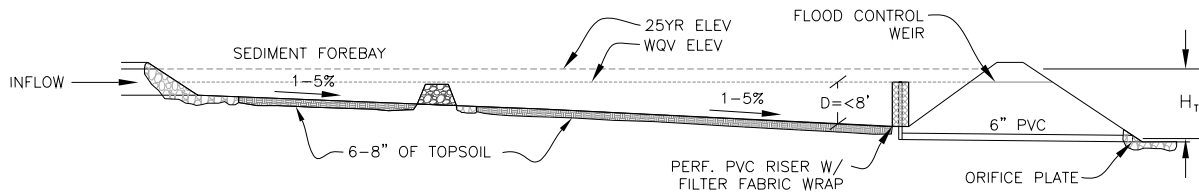

BASIN PROFILE

Figure 4-2: Extended Detention Basin Schematic

4.2.4 Sand Filter Basin

Description

A sand filter is similar to an extended detention basin except for the additional water quality treatment from a sand filter. A sand filter basin captures the complete water quality volume in a sedimentation basin for 48 hours before filtering the runoff through a bed of sand in the floor of the facility. Pollutant removal is achieved primarily by straining pollutants through the filtration media, settling of solids on the top of the sand bed, and nutrient management if the filter maintains grass cover through plant uptake. The filtration of nutrients, organics, and coliform bacteria is enhanced by a mat of bacterial slime that develops during normal operations. The sand filter basin must be designed off-line. See Figure 4-3 for a sand filter basin diagram.

Application

A sand filter basin cannot be used as a stand alone BMP to obtain compliance with the Highland Lakes Watershed Ordinance and requires secondary treatment in the form of vegetative filter strips, an infiltration basin/trench or a bioretention basin.

Similar to an extended detention basin, a major advantage of a sand filter basin is their adaptability; they can be used on areas with thin soils, high evaporation rates, low-soil infiltration rates, in limited-space areas, and where groundwater is to be protected. A sand filter basin also tends to have good longevity due to their offline design and the high porosity of the sand media. Without proper maintenance, a sand filter is prone to clogging, which can reduce performance and lead to nuisances associated with standing water. Also a sand filter often is perceived to have negative aesthetic appeal, especially when not maintained, thus landscaping and basin shape should be carefully considered.

Design Guidelines

- (1) *Contributing Drainage Area:* Less than 20 acres recommended.
- (2) *Pre-treatment:* Sand Filters require a full sedimentation basin prior to the sand filter. A full sedimentation basin captures 100% of the required water quality volume and releases it over a 48 hour period to the filtration chamber.
- (3) *Secondary Treatment:* Required either before or after the pond in the form of a vegetative filter strip, an infiltration basin/trench or a bioretention basin.

Up-gradient

Natural Vegetative Filter Strip	WQV* 0.77
Engineered Vegetative Filter Strip	WQV* 0.39
Vegetative Infiltration Strip	WQV* 0.26

Down-gradient

Natural Vegetative Filter Strip	WQV* 0.3
Engineered Vegetative Filter Strip	WQV* 0.15
Vegetative Infiltration Strip	WQV* 0.1
Infiltration Basin	WQV* 0.044
Infiltration Trench (Void)	WQV* 0.023
Infiltration Trench (length) + VFS*	WQV* 0.0045 (see below for VFS information)
Bioretention	WQV*0.033

WQV = Required Water Quality Volume as calculated in Chapter 2.3 (cubic feet)

When the infiltration trench option is used, it also serves as a flow spreader. Optimal pollutant removal within a limited BMP footprint is provided when the sand filter is used in combination with an infiltration trench and vegetated filter strip.

* The vegetated filter strip must be located up-gradient of the buffer zone and be at least 15 feet in width if an engineered filter strip is proposed and at least 30 feet in width if a natural filter strip is used. In addition, follow the guidance in 4.2.7, Vegetative Filter Strips.

- (4) *Basin Sizing:* The required BMP Volume is calculated by applying a factor of 1.05 to the Water Quality Volume (WQV) calculated per Chapter 2.3. The WQV is increased by a factor of 5% to accommodate for the reduction in the available storage volume due to deposition of solids in the time between full-scale maintenance activities.

$$\text{BMP Volume} = \text{WQV} * 1.05$$

WQV = Required Water Quality Volume as calculated in Chapter 2.3 (cubic feet)

- (5) *Basin Configuration:* Sand filters must be configured to have separate basins for sedimentation and filtration. Typically this design includes a wall with a riser pipe between the sedimentation and filtration basins (separate basins) with the sedimentation basin sized to contain the entire design capture volume. The separation wall or berm must extend above the pond overflow elevation for the 25-year event.
- (6) *Sedimentation Basin:* Should have a ratio of flow-path length to width from the inlet to the outlet of at least 2:1 (L:W). The flow-path length is defined as the distance from the inlet to the outlet as measured at the surface. The width is defined as the mean width of the basin. Outlets should be placed to maximize the flow-path through the facility. The basin should maintain a longitudinal slope between 1.0 – 5.0% with a lateral slope between 1.0 – 1.5%. A low flow channel should be provided through the sedimentation basin if erosive velocities are present. The channel should be stabilized and permeable, not concrete.
- (7) *Sedimentation Basin Soils:* To enhance infiltration and water storage within the sedimentation basin, topsoil must be placed on the basin floor after excavated bottom is scarified to a depth of 2 to 3 inches to improve drainage. The topsoil must be 3 to 5 inches deep and a soil mixture of 30-40% sand or granite sand, 60-70% topsoil, and suggest 5-10% compost to aid water retention and promote vegetation growth. Soil blend must have clay content less than 20 percent and be free of stones, stumps, roots or other similar objects larger than one (1) inch. If on-site soils do not meet these specifications, topsoil per the above specs must be added. Sandy loam is not an approved soil and caliche is not considered a soil.
- (8) *Sand Filter Area:* The minimum required filter area for sand filters with a full sedimentation basin is:

$$A_f = \frac{WQV}{18}$$

A_f = minimum surface area for the filtration basin (sf)

WQV = water quality volume (cf)

- (9) *Basin Depth:* The water quality depth in the sedimentation basin when full should no greater than 8 feet.
- (10) *Basin Inlet:* Flow-splitting device required for the sand filter. The sedimentation basin can be designed on-line. See General Guidelines Item No.7 for the flow-splitting device requirements.
- (11) *Sedimentation Pond Outlet Structure:* The outflow structure consists of a perforated riser within the sedimentation basin and discharging to the filtration basin per Figure 4-3. Non woven filter fabric with a minimum opening of **0.15 mm** (U.S. Sieve Size 100) shall be wrapped around the riser to enhance detention. The receiving end of the sand filter should be protected (splash pad, riprap, etc.) such that erosion of the sand media does not occur. The outlet of the sedimentation basin should have flow control so that the sedimentation basin drains 48 hours. This can be accomplished through the use of an orifice. The orifice equation provided for an extended detention basin in Section 4.2.3 can be used to determine the required orifice size. The riser pipe should have a minimum diameter of 6 inches with four 1-inch perforations per row. The vertical spacing between rows should be 4 inches (on centers). Refer to Figure 4-4 for a detail of a sedimentation pond outlet structure.
- (11) *Sand and Gravel Configuration:* The sand filter is constructed with 18 inches of sand overlying a gravel layer. The gravel layer wraps around an underdrain that is used to drain captured flows from the gravel layer. Two options are presented in Figure 4.5 for configuration of the underdrain and gravel configuration.
- (12) *Sand Properties:* The sand grain size distribution should be comparable to that of “washed concrete sand” (i.e., ASTM C-33 fine aggregate with grain size of 0.02-0.04 inches).
- (13) *Underdrain Pipe:* The underdrain piping should consist of a main collector pipe and two or more lateral branch pipes spaced at intervals of no more than 10 feet. The underdrain requirements presented in General Guidelines Item No. 8 are required.

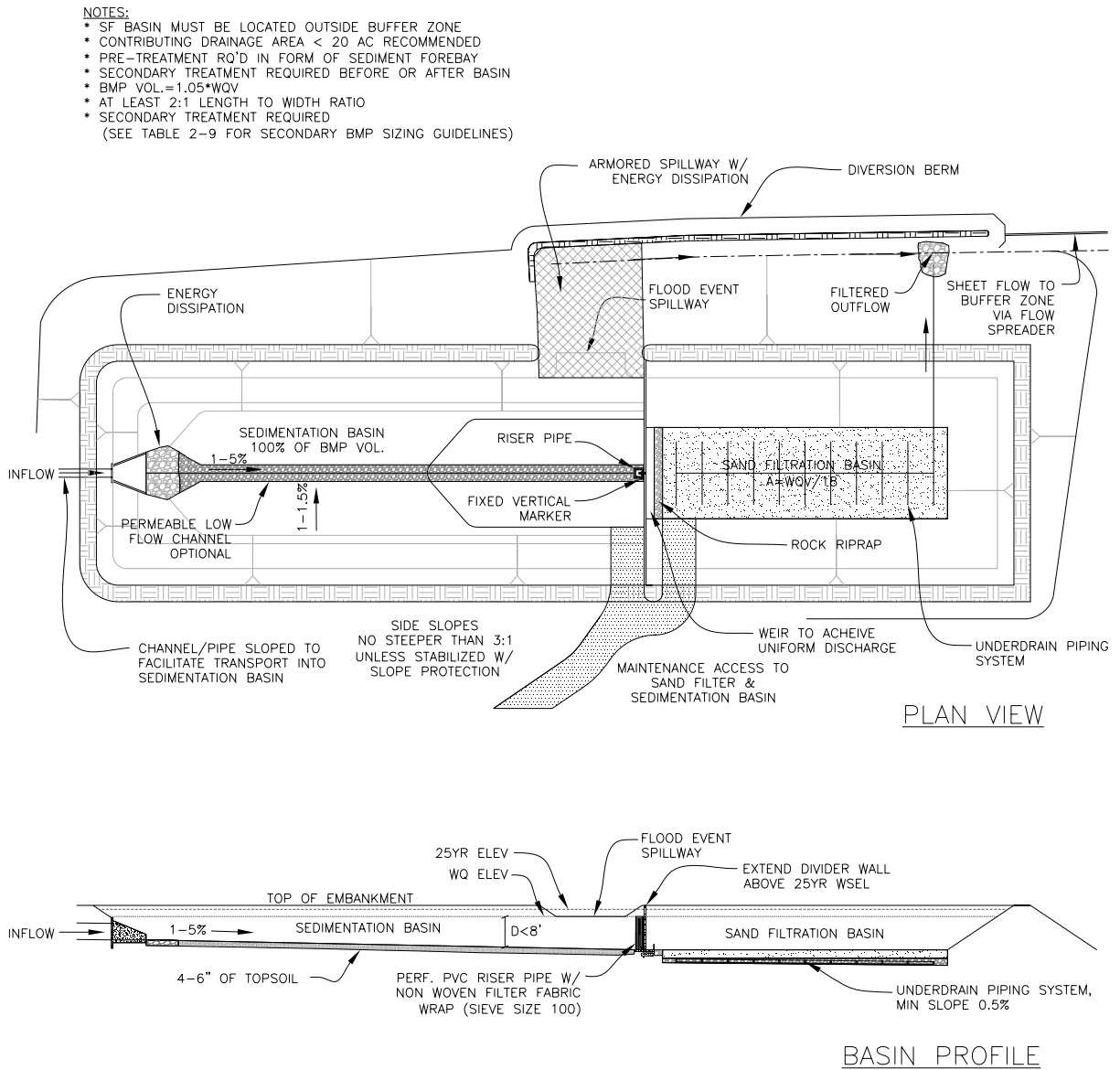

Figure 4-3: Sand Filter System Schematic

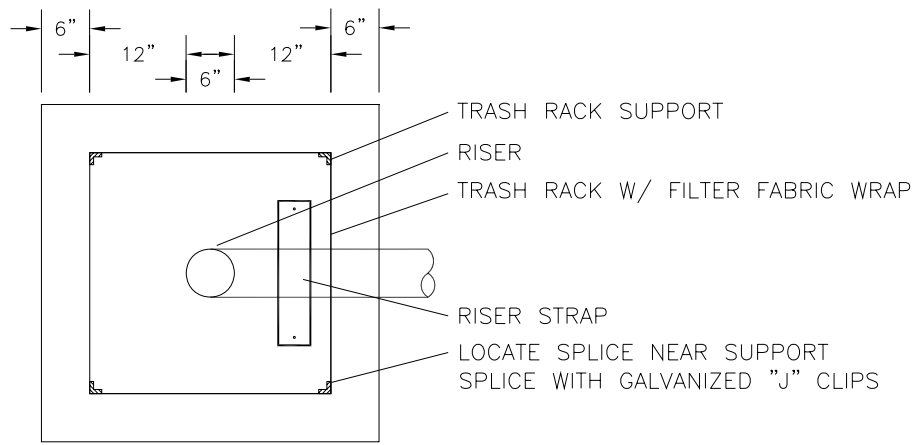
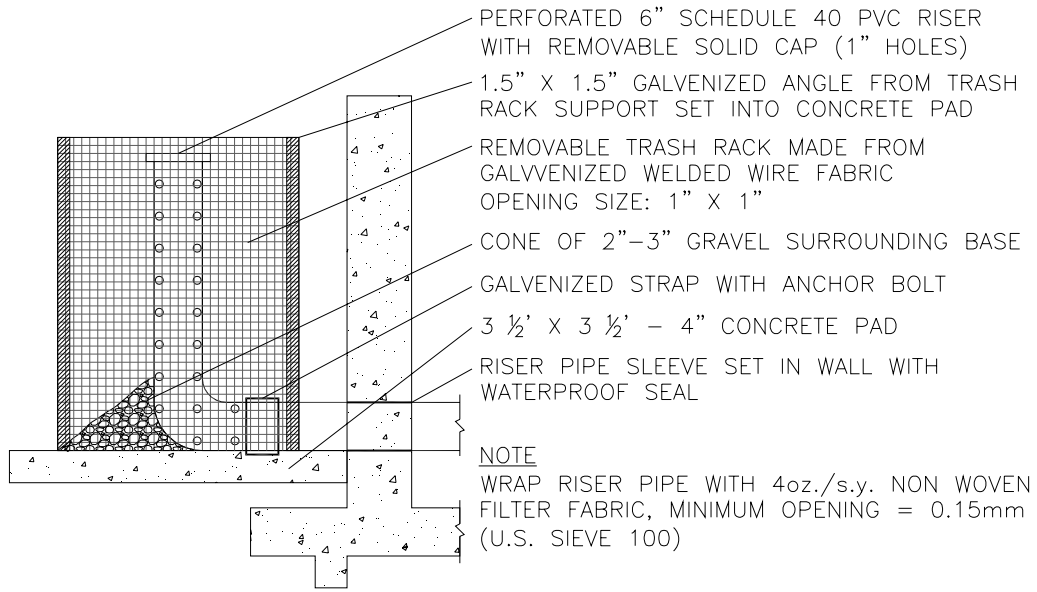

Figure 4-4: Detail of Sedimentation Riser Pipe

PERFORATION LAYOUT

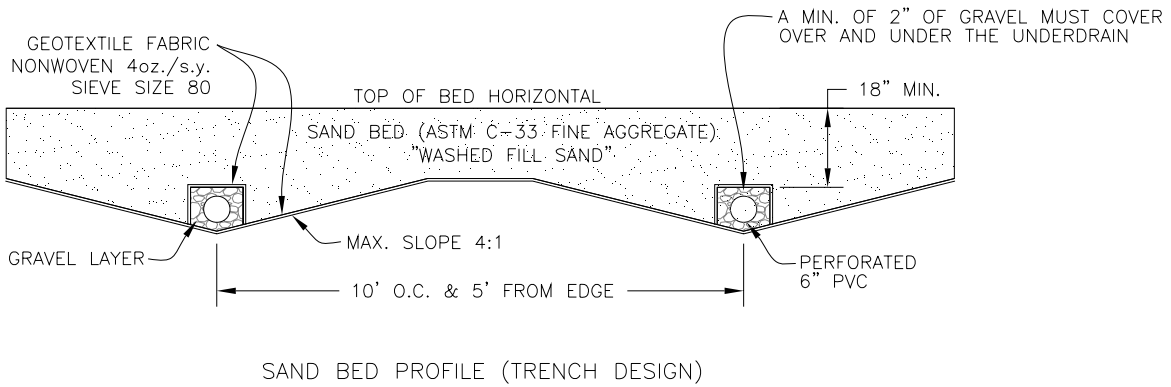
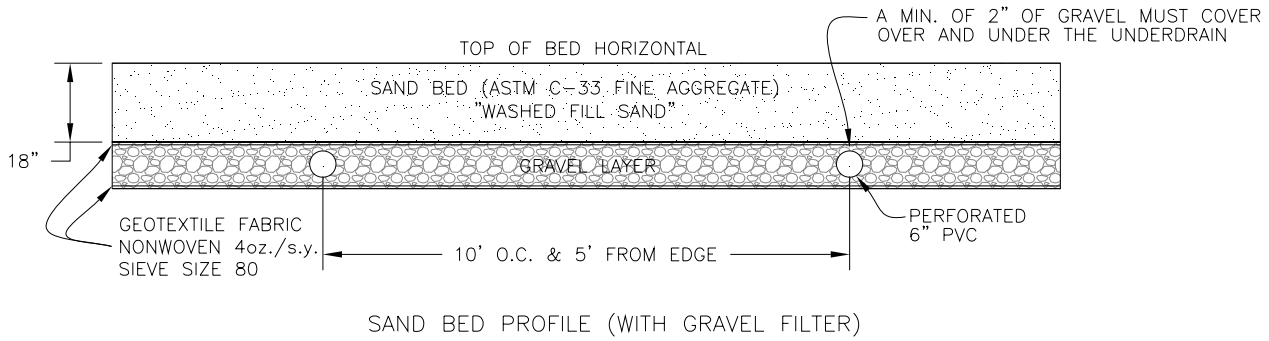
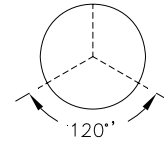

Figure 4-5: Sand Bed Profile Schematic

4.2.5 Wet Basins

Description

Wet detention practices are characterized by the presence of a permanent pool or wetlands area with a healthy stand of emergent vegetation and an abundant microbial population. Wet basins are effective primarily because they provide excellent particle sedimentation and limit resuspension of sedimentation. Wet basins provide erosion protection for the receiving channel by limiting peak flows during larger storm events.

This manual presents two wet detention practices; wet ponds and stormwater wetlands. A wet pond generally refers to a stormwater capture facility with a permanent, relatively deep, open water element and emergent vegetation around the facility's perimeter while a stormwater wetlands refers to a shallow pond with or without open water elements that create growing conditions suitable for marsh plants. Refer to Figure 4-6 for a schematic of a wet pond and Figure 4-7 for a schematic of a wetland.

Application

A wet basin can be used as stand alone BMP when it incorporates an infiltration bench within the basin area. Without the infiltration bench, a wet basin cannot be used as a stand alone BMP to meet the requirements of the LCRA Highland Lakes Watershed Ordinance and required secondary treatment in the form of vegetative filter strip, infiltration basin/trench or a bioretention basin.

Wet basins can be designed to provide an aesthetic water quality solution. However, a significant potential drawback for wet basins in the central Texas area is that the contributing watershed for these facilities is often incapable of providing an adequate water supply to maintain the permanent pool, especially during the summer months. Other water sources are sometimes used to supplement the rainfall/runoff process, especially for wet pond facilities treating smaller, more densely developed watersheds. Therefore, wet basins are recommended for use with drainage areas of at least 20 acres.

Design Guidelines

A) Wet Ponds

Wet ponds are stormwater quality control facilities that maintain a permanent wet pool and a standing crop of emergent littoral vegetation. These facilities may vary in appearance from natural ponds to enlarged, bermed (manmade) sections of drainage systems and may function as online or offline facilities, although offline configuration is preferable. Offline designs can prevent scour and other damage to the wet pond and minimize costly outflow structure elements needed to accommodate extreme runoff events.

- (1) *Contributing Drainage Area:* Contributing drainage area between 20 and 128 acres recommended. If the contributing drainage area is less than 20 acres a water

balance for the proposed facility is necessary to determine if any and how much makeup water is required to provide and maintain the permanent pool.

- (2) *Pre-treatment:* A sediment forebay is required to isolate sediment as it enters the facility to simplify sediment removal and to reduce overall maintenance of the basin. Two types of forebay designs are described below. The dry sediment forebay is recommended for ease of sediment removal.
- i. *Dry Sediment Forebay:* The bottom of the sediment forebay should be 12” higher than the permanent pool and the outlet should be earthen with a rock riprap opening that is not inline with the basin inlet or outlet. Also refer to the design guidelines for sediment forebays in General Guidelines Item No. 7.
 - ii. *Interbasin Pipe Option:* A sediment forebay may also be located below the permanent pool and connected to the permanent pool via an inter-basin pipe. A shut-off valve must be provided for the inter-basin pipe to allow for sediment forebay maintenance without draining the permanent pool.
- (3) *Secondary Treatment:* Required either before or after the pond in the form of a vegetative filter strip, an infiltration basin or an infiltration trench when an infiltration bench is **not** incorporated within the basin.

Up-gradient

Natural Vegetative Filter Strip	WQV* 0.69
Engineered Vegetative Filter Strip	WQV* 0.35
Vegetative Infiltration Strip	WQV* 0.23

Down-gradient

Natural Vegetative Filter Strip	WQV* 0.26
Engineered Vegetative Filter Strip	WQV* 0.13
Vegetative Infiltration Strip	WQV* 0.09
Infiltration Basin	WQV* 0.042
Infiltration Trench (Void)	WQV* 0.023
Infiltration Trench (length) + VFS*	WQV* 0.0043 (see below for VFS information)
Bioretention Basin	WQV*0.029

Stand alone – no secondary treatment is necessary

Infiltration bench area within basin WQV * 0.17 (square feet)

WQV = Required Water Quality Volume as calculated in Chapter 2.3 (cubic feet)

When the infiltration trench option is used, it also serves as a flow spreader.

* The vegetated filter strip must be located up-gradient of the buffer zone and be at least 15 feet in width if an engineered filter strip is proposed and at least 30 feet in width if a natural filter strip is used. In addition, follow the guidance in 4.2.7, Vegetative Filter Strips.

- (4) *Basin Sizing:* The basin should be sized to hold the required permanent pool volume and the BMP Volume. The required BMP Volume is stored above the permanent pool.

The volume of the permanent pool should equal 80% of the calculated WQV unless using the inter-basin pipe option where the permanent pool should be equal 100% of the calculated WQV. The required BMP Volume is calculated by applying a factor of 1.05 to the Water Quality Volume (WQV) calculated per Chapter 2.3. The WQV is increased by a factor of 5% to accommodate for the reduction in the available storage volume due to deposition of solids in the time between full-scale maintenance activities.

Permanent Pool = WQV * 0.8 (Dry Forebay)

Permanent Pool = WQV (Inter-basin Pipe Option)

BMP Volume = WQV * 1.05

WQV = Required Water Quality Volume as calculated in Chapter 2.3 (cubic feet)

- (5) *Basin Configuration:* The wet basin should be configured as a two stage facility with a sediment forebay and a main permanent pool. The basins should be wedge-shaped, narrowest at the inlet and widest at the outlet if possible. The ratio of flow-path length to width from the inlet to the outlet should be at least 2:1 (L:W). The flow-path length is defined as the distance from the inlet to the outlet as measured at the surface. The width is defined as the mean width of the basin. Higher length-to-width ratios are recommended. Outlets should be placed to maximize the flow-path through the facility. When an infiltration bench is included to create a stand alone BMP, the slope across the bench shall not exceed 2%. The safety bench along the wet pool can be included in the infiltration bench area. In addition, the 1-year storm must ly inundate the entire infiltration bench by at least 12 inches.
- (6) *Permanent Pool:* The permanent pool should be no deeper than 8 feet and should average 4-6 feet deep. The perimeter of all permanent pool areas shall be surrounded by two benches. A flat (no steeper than 2 percent) safety bench at least 10 feet wide shall be provided adjacent to the boundary of the permanent pool. An aquatic bench extending inward at least 10 feet wide from the perimeter of the permanent pool and no more than 18 inches below normal depth shall also be provided. See Figure 4-6.
- (7) *Outflow Structure:* An outlet should be provided that will drain the water quality volume in 48 hours. The outlet must utilize a trash rack, a hood or other device to prevent clogging. Figure 4-7 presents a schematic representation of acceptable outflow structures. The facility should have a separate drain pipe with a manual valve that can completely or partially drain the pond for maintenance purposes. To allow for possible sediment accumulation, the submerged end of the pipe should be protected, and the drain pipe should be sized one pipe schedule higher than the calculated diameter needed to drain 90% of the permanent pond within

24 hours. The valve should be located at a point where it can be operated in a safe and convenient manner.

- (8) *Pond Lining:* The wet basin must maintain its permanent pool. Lining of the permanent pool with a 12” clay liner or an approved impermeable liner is required. When incorporating an infiltration bench to create a stand alone basin, the topsoil shall have a depth of 6 to 8 inches and follow the soil requirements for engineered vegetated filter strips.
- (9) *Mosquito Control:* To minimize problems with mosquitoes, *Gambusia affinis* (mosquito fish) or other similar native species should be stocked at a minimum initial density of 200 individuals per surface acre. Microbial larvicides such as *Bacillus thuringiensis israelensis* (Bti) and *Bacillus sphaericus* (B. sphaericus) can be used as an alternate method of mosquito control. These are nontoxic products in the form of disks and can be found in garden supply stores.
- (10) *Aeration:* The performance and appearance of a wet pond may be improved by providing aeration of the permanent pool; however, this is not a requirement.
- (11) *Vegetation:* Establishment of wetland vegetation will minimize potential invasion by undesirable species and facilitate healthy pond ecology. Therefore, a vegetation plan must be prepared that indicates how aquatic and terrestrial areas will be stabilized in terms of vegetation. Wetland species appropriate for a warm weather climate and planting guidelines are shown below.

Wetland Plant List

Install Bulrush in clumps, with individual plants spaced approximately three to four feet on center: At least two of the following species should be used:

BULRUSH	WATER DEPTH	NOTES
Schoenoplectus tabernaemontani, Bulrush	1’ - 3’	8’ tall evergreen, resists cattail encroachment
Schoenoplectus californicus, Bulrush	1’ - 3’	8’ tall evergreen, resists cattail encroachment
Schoenoplectus pungens, Three-square bulrush	2” - 6”	2’ to 4’ tall, w/ 3 distinct edges; tolerant of some drying
Cladium jamaicense, Sawgrass	6” -2’	4’ to 8’ tall, resists encroachment from everything, shade tolerant. Sawgrass root systems should be transplanted in winter. Also propogates readily from seed. Sawgrass root systems should be transplanted in winter. Also propogates readily from seed.

At least two species of the following marsh plants should be used (additional species are encouraged). Install in clumps in shallow water, with individual plants spaced at approximately three feet on center:

MARSH DIVERSITY	WATER DEPTH	NOTES
1. <i>Cyperus ochraeus</i> , Flatsedge	2" - 6"	1' to 2' tall, clump-forming, common to central Texas
2. <i>Dichromena colorata</i> , White-topped Sedge	2" - 6"	1' to 2' tall, white bracts during warm season
3. <i>Echinodorus rostratus</i> , Burhead	3' - 1'	1' to 2' tall, annual, heart-shaped leaves, flower similar to arrowhead
4. <i>Eleocharis quadrangulata</i> , Four-square Spikerush	6" - 1'	1' to 2' tall, colonizes, inhabits deeper water than other Spikerushes
5. <i>Juncus effusus</i> , Soft Rush	6" - 1'	3' to 4' tall, forms a tight clump, evergreen, very attractive
6. <i>Justicia americana</i> , Water willow	2" - 6"	2' to 3' tall, common, white flowers, herbaceous, colonizes
8. <i>Marsilea macropoda</i> , Water Clover	2" - 6"	Looks like floating four-leaf clover, endemic to Texas
9. <i>Najas guadalupensis</i> , Water-Naiad	1' - 4'	Submergent, valuable to fish and wildlife
10. <i>Pontederia cordata</i> , Pickerelweed	2" - 1'	3' tall, colonizes, cosmopolitan, purple flowers
11. <i>Rhynchospora corniculata</i> , Horned-rush	2" - 6"	2' to 3' tall, brass-colored flowers in May
<i>Hydolea ovata</i> , Hairy Hydolea	6" - 2'	2'-3' tall, showy blue flowers in September

Install spikerush at or near the water's edge, with individual plants spaced approximately three to six feet on center. At least two of the following species should be used:

SPIKERUSH	WATER DEPTH	NOTES
<i>Eleocharis montevidensis</i> , Spikerush	0" - 6"	1' tall, rhizomatous, reduces erosion at the pond edge
<i>Eleocharis macrostachys</i> , Spikerush	0" - 6"	1' tall, rhizomatous, reduces erosion at the pond edge
<i>Eleocharis quadrangulata</i> , Spikerush	3" - 1'	2' to 2.5' tall, rhizomatous, can accommodate deeper water, 4-angled
<i>Hydrocotyle umbellata</i> and <i>H. verticillata</i> , Water Pennyworts	0 - 3"	6" tall, rhizomatous, reduces erosion at pond's edge
<i>Phyla</i> spp. frogfruit	1 - 2"	6", sprawling and rhizomatous, drought tolerant for upper reaches of wet areas
<i>Polygonum</i> spp. smartweeds	1' - 1'	2' - 4', high wildlife value, pink and white flowers

Install Arrowhead in clumps in shallow water, with individual plants spaced approximately three feet on center.

ARROWHEAD	WATER DEPTH	NOTES
Sagittaria latifolia, Arrowhead	2"- 1'	2' height, wildlife value, white flowers, proven water quality performer
Echinodorus berteroi, Burhead	2"- 1'	2' height, tolerates fluctuating water levels, very hardy and widespread in Texas

Floating-leaved aquatic plants are rooted in the sediment of the pond, and have leaves that float on the surface of the water. These leaves shade the water, which limits potential algae growth. At least two of the following species should be used and should be placed at random locations throughout the pond:

AQUATICS	WATER DEPTH	NOTES
1. Cabomba caroliniana, Fanwort	1' - 4'	Approximately 6' length underwater, submergent
2. Ceratophyllum spp., Coon-tail	1' - 4'	Maximum 8' length, tolerant of turbidity and water fluctuation, wildlife food
3. Nymphaea odorata, Fanwort	6" - 2'	A native, reliably hardy, floating-leaved aquatic, with white flowers
4. Potamogeton pectinatus, Sago Pondweed	8" - 3'	Colonizes quickly, valuable to fish and wildlife; floating-leaved aquatic

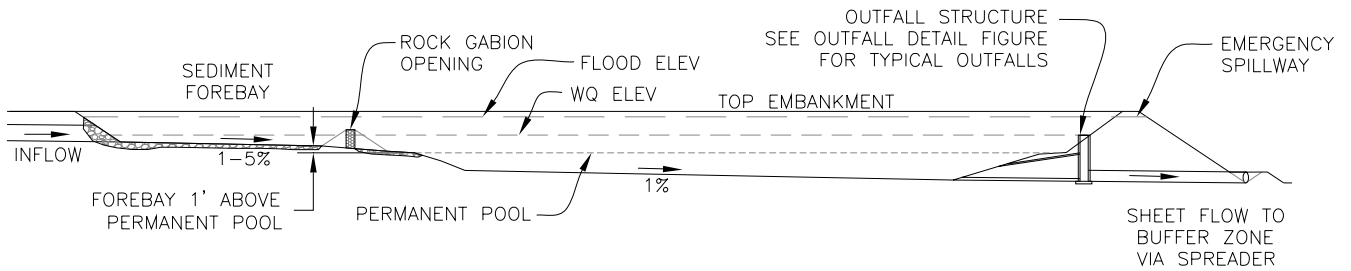
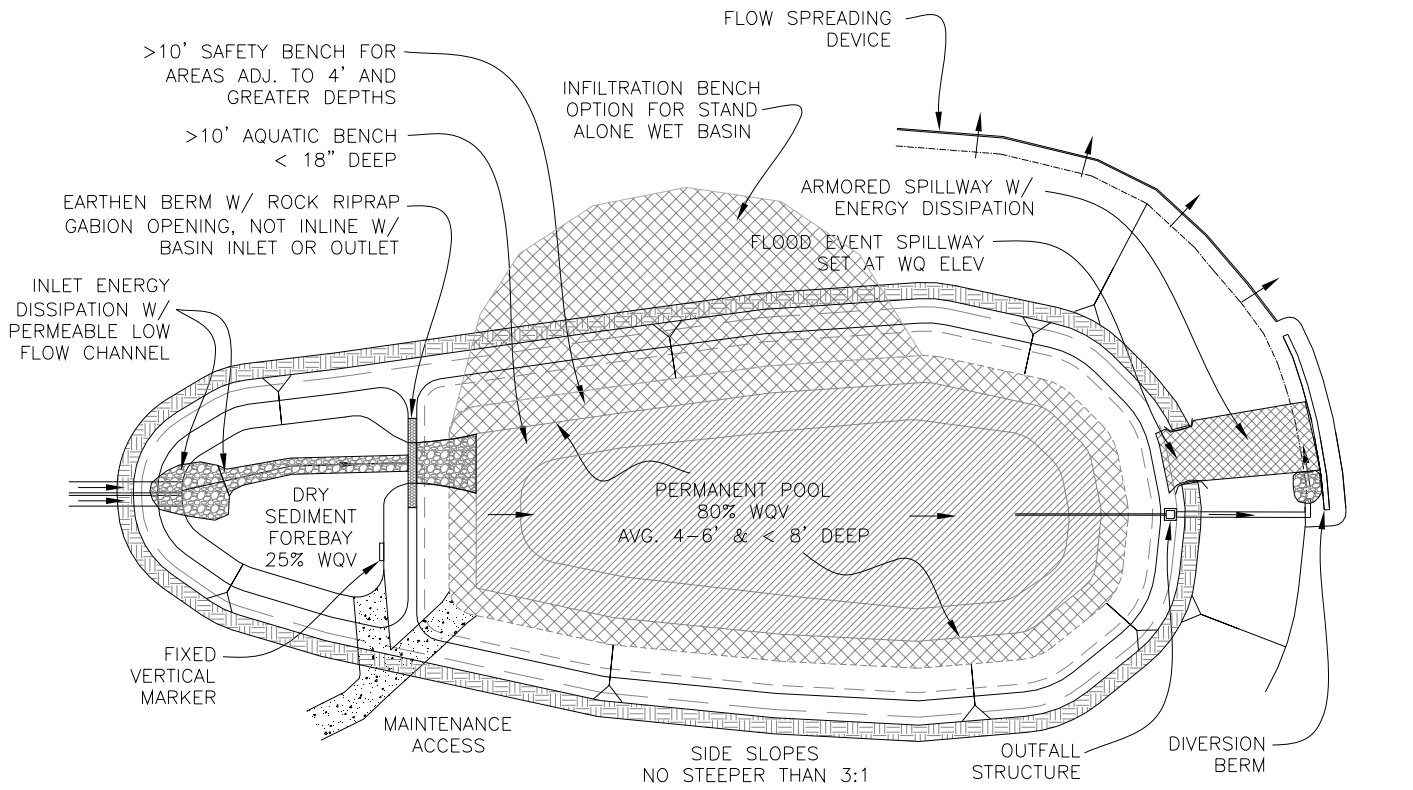

NOTES

- * CONTRIBUTING DRAINAGE AREA 20 TO 128 ACRES
- * PRETREATMENT RQ'D IN FORM OF SEDIMENT FOREBAY (MAY USE INTERBASIN PIPE)
- * SECONDARY TREATMENT RQ'D
- * ON-LINE OR OFF-LINE
- * WEDGED SHAPE > 2:1 LENGTH TO WIDTH RATIO
- * 12" CLAY LINER OR IMPEARMEABLE LINER
- * MOSQUITO CONTROL REQUIRED
- * WETLAND VEGETATION RQ'D
- * PROVIDE ADEQUATE MAINTENANCE ACCESS

BASIN SIZING

BMP VOL (CF) = WQV * 1.05
 PERMANENT POOL (CF) VOL = WQV * 0.8 (DRY FOREBAY)
 PERMANENT POOL (CF) VOL = WQV (INTERBASIN PIPE OPTION)

SECONDARY TREATMENT REQUIRED IF INFILTRATION BENCH NOT INCLUDED
 SEE TABLE 2-9 SECONDARY BMP SIZING GUIDELINES

Figure 4-6: Schematic of a Wet Pond

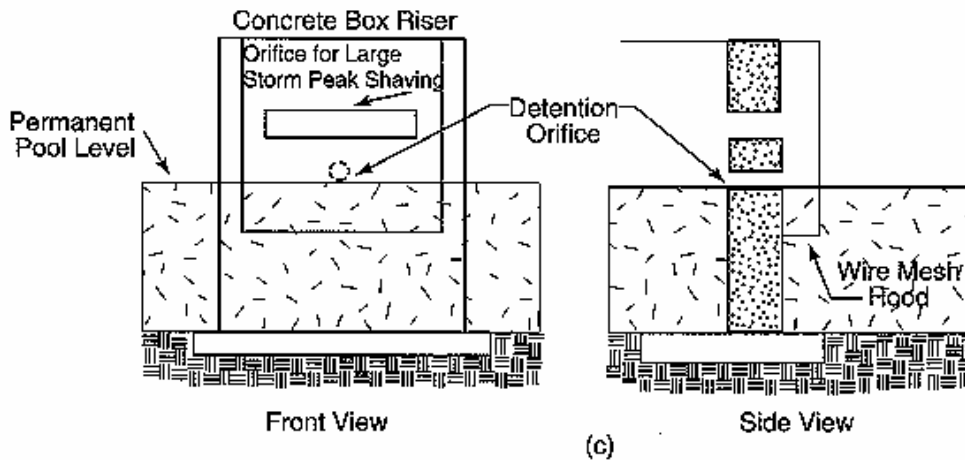
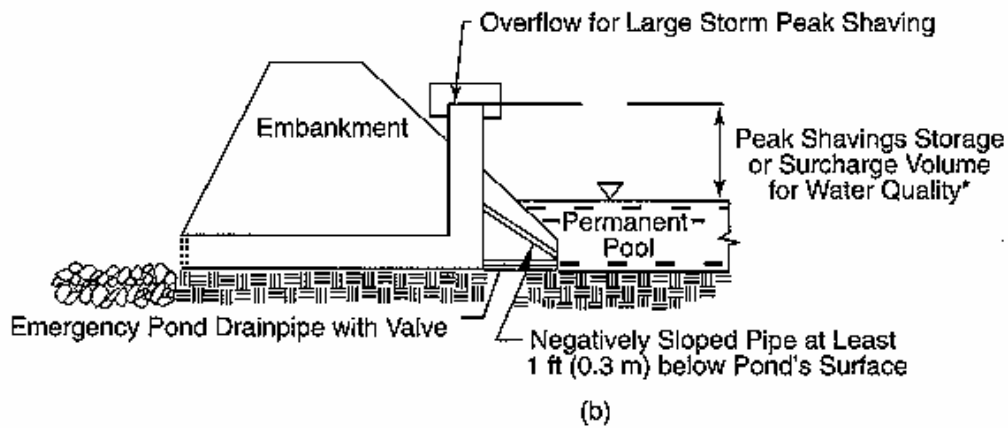
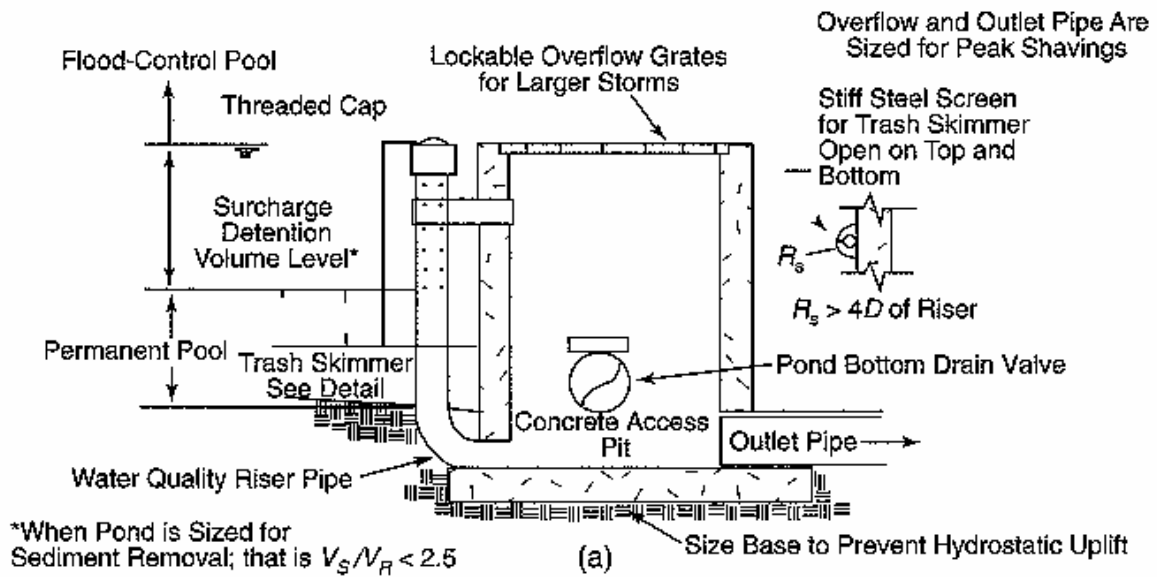

Figure 4-7: Schematic Diagrams of Wet Basin Outlets (WEF and ASCE, 1998)

B) Stormwater Wetlands

Stormwater wetlands refer to shallow pools with or without open water elements that create growing conditions suitable for marsh plants. Conventional stormwater wetlands are shallow manmade facilities supporting abundant vegetation and a robust microbial population. As constructed water quality facilities, stormwater wetlands should never be located within delineated natural wetlands areas. In addition, they differ from manmade wetlands used to comply with mitigation requirements in that they do not replicate all of the ecological functions of natural wetlands.

Guidelines are the same as for wet ponds except for the following items described below:

- (1) *Basin Configuration:* Stormwater constructed wetlands offer significant flexibility regarding pond configurations with the exception that short-circuiting of the facility must be avoided. Provision of irregular, multiple flow paths is desired. The use of open water elements (micropools) is recommended, especially near the facility outlet, both as a means of diversifying the biological community and as an aesthetic consideration. Islands may be placed in the facility to enhance waterfowl habitat and placement of trees. A flat area at least 10 feet in width (safety bench) must exist along the perimeter and be planted with an open water grass. An infiltration bench can be located within the inundation area similar to the wet pond above to serve as a stand alone BMP.
- (2) *Permanent Pool:* The permanent pool should consist of 2-4' deep open water for 30-50% of the basin surface with the remaining wetland zone (50-70%) at a depth of 0.5 to 1 foot deep. The depth of micropools shall not exceed 4 feet.
- (3) *Basin Inlet:* The basin should be designed as an offline facility, with a flow splitter device used to isolate the water quality volume. An offline basin is required unless the designer can demonstrate that extreme events will not scour wetland areas. Refer to Flow Splitter Device in General Guidelines No. 7.
- (4) *Depth of Inundation During Storm Events:* The depth of inundation of the BMP volume should not exceed 2.0 feet above the permanent pool elevation.

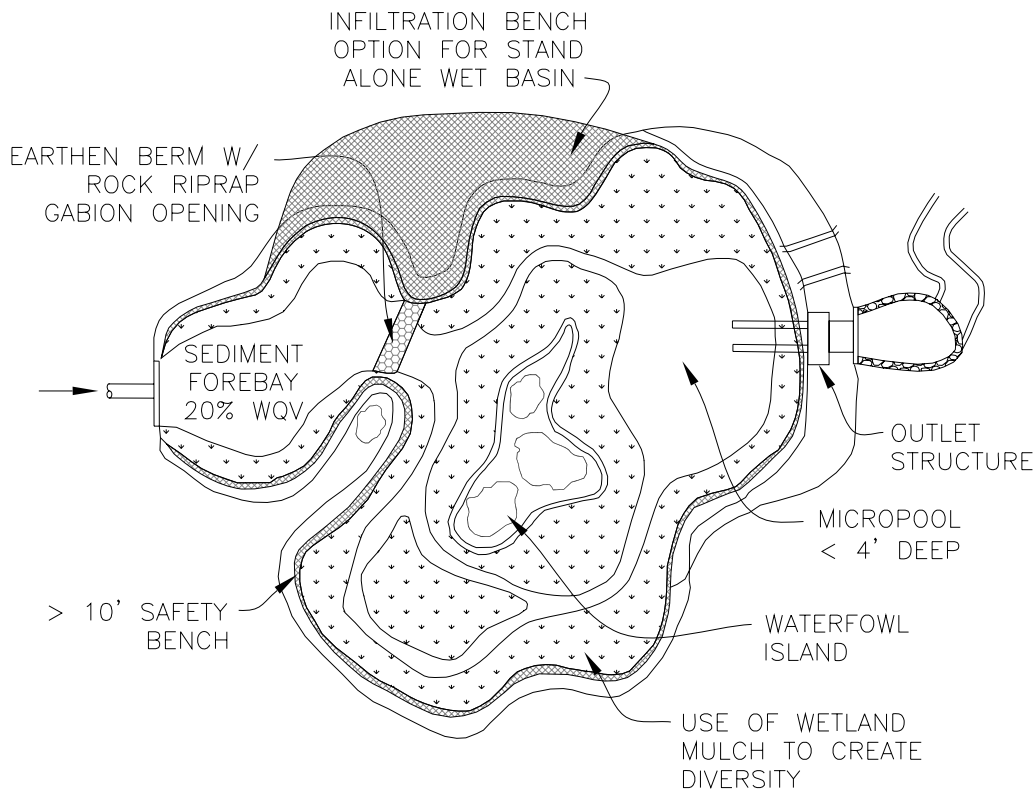

NOTES

- * CONTRIBUTING DRAINAGE AREA 20 TO 640 ACRES
- * PRETREATMENT RQ'D IN FORM OF SEDIMENT FOREBAY (MAY USE INTERBASIN PIPE)
- * SECONDARY TREATMENT RQ'D
- * OFFLINE RQ'D UNLESS DESIGNER CAN DEMONSTRATE THAT EXTREME EVENTS WILL NOT SCOUR WETLAND
- * <2' INUNDATION FOR BMP VOLUME
- * PERMANENT POOL 2-4' DEEP OPEN WATER FOR 30-50% OF BASIN SURFACE W/ REMAINING 50-70% AT A DEPTH OF 0.5-1'.
- * IRRIGULAR FLOW PATHS DESIRED
- * > 2:1 FLOW LENGTH TO BASIN WIDTH RATIO
- * 12" CLAY LINER OR IMPEARMEABLE LINER
- * MOSQUITO CONTROL REQUIRED
- * WETLAND VEGETATION RQ'D
- * PROVIDE ADEQUATE MAINTENANCE ACCESS

BASIN SIZING

- BMP VOL (CF) = WQV * 1.05
- PERM. POOL (CF) VOL = WQV * 0.8 (DRY FOREBAY)
- PERM. POOL (CF) VOL = WQV (INTERBASIN PIPE)

SECONDARY TREATMENT RQ'D

SEE TABLE 2-9 FOR SECONDARY BMP SIZING GUIDELINES

Figure 4-8: Schematic of a Constructed Wetland

4.2.6 Retention/Irrigation

Description

Retention/irrigation refers to the capture of stormwater runoff in a holding pond, then use of the captured water quality volume for irrigation of appropriate landscape areas. The goal of this technology is to roughly simulate the natural (undeveloped) hydrologic regime in which the large majority of rainfall is ultimately infiltrated and/or lost to evapotranspiration. Pollutant removal effectiveness is high, accomplished through physical filtration of solids in the soil profile and uptake of nutrients by vegetation. The function of this BMP is similar to an extended detention pond with secondary treatment through an infiltration BMP, with the infiltration component replaced by a pumped irrigation system.

Application

Due to the retention/irrigation high pollutant removal potential, it can be used as a stand alone BMP to meet the requirements of the Highland Lakes Watershed Ordinance. Retention/Irrigation is appropriate for sites where geography constrains the use of passive secondary treatment such as infiltration trenches, vegetative filter strips, etc. and where suitable irrigation areas are geographically isolated from the development area. However this approach has intensive design, construction, and maintenance requirements. The following provides some limitations of retention/irrigation systems to consider before selecting this BMP:

- Retention-irrigation is an expensive technology due primarily to mechanical systems, power requirements, and high maintenance needs;
- Due to the relative complexity of irrigation systems, they must be inspected and maintained at regular intervals to ensure reliable system function;
- Retention/irrigation systems use pumps requiring electrical energy inputs which cost money and can be interrupted. Mechanical systems are also more complex, requiring skilled maintenance, and they are more vulnerable to vandalism than simpler, passive systems;
- Retention/irrigation systems require open space for irrigation;
- Effective use of retention-irrigation requires some form of pre-treatment of runoff (i.e., sediment forebay or vegetated filter) to remove coarse sediment and to protect the long-term operating capacity of the irrigation equipment; and
- Retention/irrigation BMPs capture and store water; therefore, careful design and adherence to a maintenance program is essential to minimize the potential for mosquito breeding or other nuisance conditions.

Design Guidelines

- (1) *Contributing Drainage Area:* Less than 128 acres recommended.
- (2) *Pre-treatment:* A sediment forebay is required to extend the life of the pumps, to isolate sediment as it enters the facility, to simplify sediment removal, and to reduce overall maintenance of the basin. Refer to the design guidelines for sediment forebays in General Guidelines Item No. 7.
- (3) *Basin Sizing:* A retention/irrigation basin requires additional storage volume to provide streambank erosion protection for a sequence of flood events occurring over a period of a few days. This additional storage is calculated as half of the required Water Quality Volume (WQV) calculated per Chapter 2.3. The WQV is increased by a factor of 5% to accommodate for the reduction in the available storage volume due to deposition of solids in the time between full-scale maintenance activities.

$$\text{BMP Volume} = \text{WQV} * 0.5 + \text{WQV} * 1.05$$

$$\text{Streambank Erosion Volume} = \text{WQV} * 0.5$$

$$\text{Irrigation Volume} = \text{WQV} * 1.05$$

WQV = Required Water Quality Volume as calculated in Chapter 2.3 (cf)

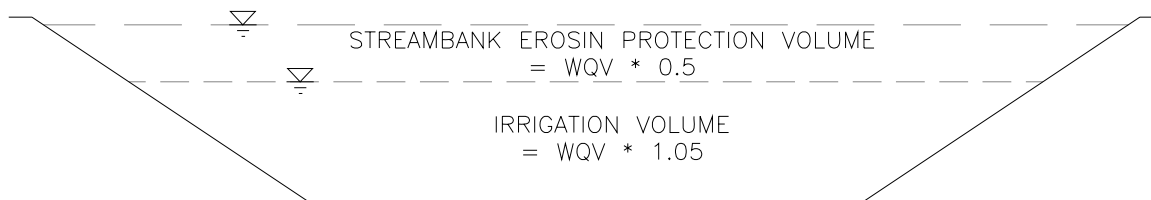

Figure 4-9: Retention/Irrigation Volume Partition

- (4) *Basin Configuration:* Capture of stormwater in retention/irrigation systems can be accomplished in virtually any kind of runoff storage facility ranging from fully dry, concrete-lined to vegetated with a permanent pool; thus, design of the storage system can be quite flexible as long as an appropriate pumps and wet well system can be accommodated.
- (5) *Pump and Wet Well System:* The pumps and wet well system should be automated with a rainfall or soil moisture sensor to allow for irrigation only during periods when required infiltration rates can be realized. Pumps and wet well must be sized to minimize pump cycling. System specifications must be approved by the LCRA. These systems should be similar to those used for wastewater effluent irrigation, which are commonly used in areas where “no discharge” wastewater treatment plant permits are issued.
- (6) *Pumps:* A duplex pump system with each pump capable of delivering 100% of flow is required for reliability purposes. The pumps must alternate on start up. A manual control must be provided so both pumps can be turned on if necessary.

Valves should be located outside the wet well on the discharge side of each pump to isolate the pumps for maintenance and for throttling if necessary. Pumps should be selected to operate within 20% of their best operating efficiency. A high/low-pressure pump shut off system (in case of line clogging or breaking) should be installed in the pump discharge piping.

- (7) *Alarms:* An alarm system should be provided consisting of a red light located at a height of at least 5 feet above the ground level at the wet well. The alarm should activate when: (1) the high water level has been maintained in excess of 72 hours, (2) the water level is below the shutoff point and the pump has not turned off, or (3) the high/low-pressure pump shut off switch has been activated. The alarm should be vandal and weather resistant. A sign should be placed at the wet well clearly displaying the name and phone number of a responsible party to be contacted if the alarm is activated.
- (8) *Wet Well:* A separate wet well outside of the basin should be provided for the pump. The wet well should be constructed of precast or cast in place concrete. A lockable cover should be provided to allow complete access to the pump and other internal components of the wet well for maintenance. An isolation valve to prevent flow from the retention basin to the wet well during maintenance activities is recommended. The wet well and pump must be designed to be low enough to completely evacuate the retention pond.
- (9) *Intake Riser:* Prior to entering the wet well, stormwater should pass through an appropriate intake riser with a screen to reduce the potential for clogging of distribution pipes and sprinklers by larger debris - e.g. cups, cans, sticks.
- (10) *Detention Time:* The irrigation schedule should allow for complete drawdown of 100% of the retained water quality volume within 72 hours if no subsequent rainfall occurs during this period. Irrigation should not begin within 12 hours of the end of rainfall so that direct storm runoff has ceased and soils are not saturated. Consequently, the length of the active irrigation period is 60 hours. The irrigation should include a cycling factor of $\frac{1}{2}$, so that each portion of the area will be irrigated for only 30 hours during the total of 60 hours allowed for disposal of the water quality volume. Continuous application on any area should not exceed 2-hours. Division of the irrigation area into two or more sections such that irrigation occurs alternately in each section is an acceptable way to meet this recommendation. Irrigation also should not occur during subsequent rainfall events. If subsequent rainfall events produce runoff, then irrigation should not reinstate within 12 hours of the event.
- (11) *Irrigation System:* All irrigation system distribution and lateral piping (i.e. from the pumps to the spray heads) should be Schedule 80 PVC. All pipes and electrical bundles passing beneath driveways or paved areas should be sleeved with PVC Class 200 pipe with solvent welded joints. Sleeve diameter must equal twice that of the pipe or electrical bundle. All pipes and valves should be marked to indicate that they contain non-potable water. All piping must be buried to

protect it from weather, vandalism, and vehicular traffic. Velocities in all pipelines should be sufficient to prevent settling of solids.

- (12) *Valves:* All valves should be designed specifically for sediment bearing water, and be of appropriate design for the intended purpose. All remote control, gate, and quick coupling valves should be located in ten-inch or larger plastic valve boxes.

Sprinklers – All sprinkler heads should have full or partial circle rotor pop-up heads and must be capable of delivering the required rate of irrigation over the designated area in a uniform manner. Irrigation must not occur beyond the limits of the designated irrigation area. Partial circle sprinkler heads can be used as necessary to prevent irrigation beyond the designated limits. Sprinkler heads should be capable of passing solids that may pass through the intake. Sprinkler heads should be flush mounted and encased within a 2' x 2' concrete housing capable of protecting the head from mowing and service equipment. An example is in Figure 4-10.

- (13) *Irrigation Site Criteria:* Irrigation is not permitted in creek buffer zones. The area selected for irrigation must be pervious, on slopes of less than 20% unless the irrigation area contains intermediate slopes of less than 10%. Irrigation on slopes over 10% may require construction of berms to retain runoff in the event of over-irrigation. A soil investigation is necessary for proposed irrigation areas to assure that there is a minimum of 6-inches and an average of 12-inches of soil cover. Rocky soils are acceptable for irrigation; however, the coarse material (diameter greater than 0.5 inches) should not account for more than 30% of the soil volume. Optimum sites for irrigation include recreational and greenbelt areas as well as landscaping in commercial developments. The stormwater irrigation area should be distinct and different from any areas used for wastewater effluent irrigation. Finally, the area designated for irrigation should have at least a 100-foot buffer from wells, septic systems, natural wetlands, and streams.
- (14) *Irrigation Area:* The irrigation rate must be low enough so that the irrigation does not produce any surface runoff; consequently, the irrigation rate may not exceed the permeability of the soil. The minimum required irrigation area should be calculated using the following formula:

$$A = \frac{12 \times V}{T \times r}$$

where:

A = area required for irrigation (ft²)
 V = water quality volume (ft³)
 T = period of active irrigation (30 hr)
 r = Permeability (in/hr)

The permeability of the soils in the area proposed for irrigation should use one of the following:

- (1) Infiltrometer testing using a double ring infiltrometer (ASTM D 3385-94). At least one test per 10,000 square feet;

- (2) County soil surveys prepared by the Natural Resource Conservation Service (previously known as the Soil Conservation Service). If a range of permeabilities is reported, the lowest value should be used. A site reconnaissance by LCRA is necessary for verification of soil type; or
- (3) If no permeability data is available, a value of 0.1 inches/hour should be assumed.

It should be noted that the minimum area requires intermittent irrigation over a period of 60 hours at low rates to use the entire water quality volume. This intensive irrigation may be harmful to vegetation that is not adapted to long periods of wet conditions. In practice, a much larger irrigation area will provide better use of the retained water and promote a healthy landscape.

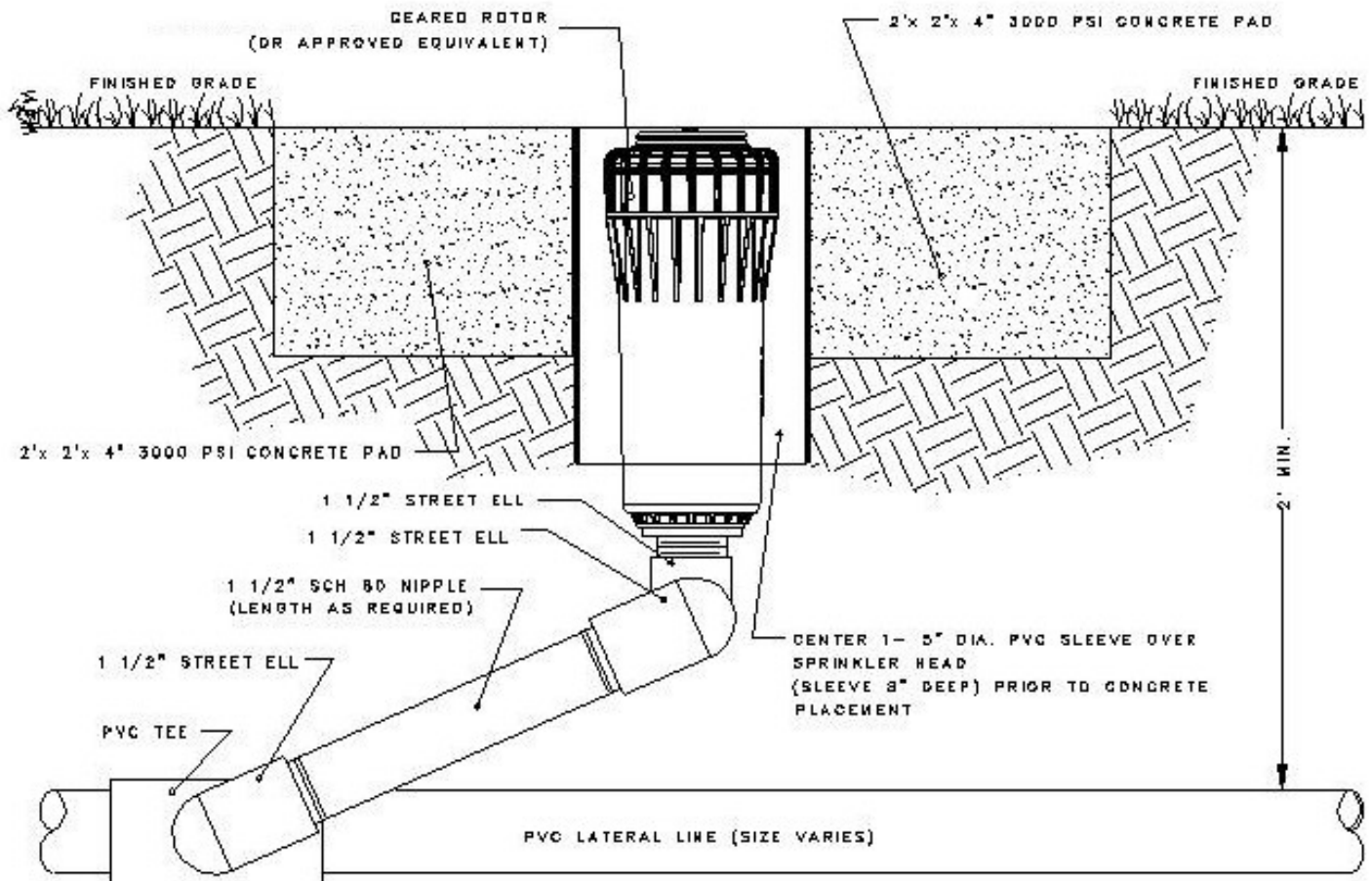

NOTES:
 SPRINKLER HEADS SHOWN ON THIS THIS SHEET SHALL BE ROTOR SPRAY HEADS (OR APPROVED EQUIVALENT) 60 PSI, 34 GPM, NOZZLE 3/8 (RED .335" DIA.). THEY SHALL HAVE AN ANGLE ROTATION OF 227 (UNLESS OTHERWISE NOTED) AND 88' RADIUS.

SWING INSTALLATION DETAIL

NO SCALE

Figure 4-10: Sprinkler Head Detail (TCEQ 2005 Edwards Aquifer Tech. Guidance Manual)

4.2.7 Vegetative Filter Strips

Description

Vegetated filter strips are densely vegetated sections of land designed to accept runoff as overland sheet flow. Dense vegetative cover facilitates conventional pollutant removal through detention, filtration by vegetation, and infiltration. Vegetated filter strips can either utilize natural filter strips or be engineered to maximize water quality benefits.

Natural vegetated filter strips make use of existing natural buffers and offer a passive low cost alternative. Natural vegetated filter strips require a slope of less than 12%, an allowable flow length between 30 and 60 feet, and an average soil depth of 4 inches. Natural vegetated filter strips require twice the land area of an engineered vegetated filter strips.

Engineered vegetative filter strips are specifically designed and constructed to maximize the water quality benefits of filter strips, particularly in areas where adequate buffers do not exist. Two types of engineered vegetative filter strips are presented in this manual; engineered vegetative filter strips and engineered vegetative infiltration strips.

Engineered vegetative filter strips differ from natural vegetative filter strips in that they can be placed on slopes up to 20% when combined with an infiltration berm, and require a flow length between 20 and 40 feet, a minimum of 6-inches of topsoil, and a uniform and even surface.

Engineered vegetative infiltration strips provide additional pollutant removals through the use of enhanced infiltration practices. Vegetative infiltration strips require a slope less than 10%, a flow length between 15 and 60 feet, a minimum of 12 inches of topsoil, infiltration berms spaced on intervals of 15 feet, and a uniform and even surface.

The natural and engineered filter strips include a terraced sloped option, which can take advantage of the natural infiltration processes located within the “stair step” topography commonly found within the Glen Rose Formation in the Highland Lakes watershed (Refer to Figure 4.11 below). These natural terraces are effective at infiltrating or abstracting runoff, settling out pollutants, and preventing erosion. Waters are retained within “deep” skeletal soils along risers despite steep slopes. Likewise, some incident water is also retained along the gently sloping treads despite thin soils having low moisture retention (Refer to Figure 4.12 below). In this way, the stair-step form of the terrain is itself a buffer, whereby the risers and treads form multiple barriers to down slope movement of surface water and entrained sediment. Where natural terraces do not exist, they can be engineered to treat runoff from developed areas.

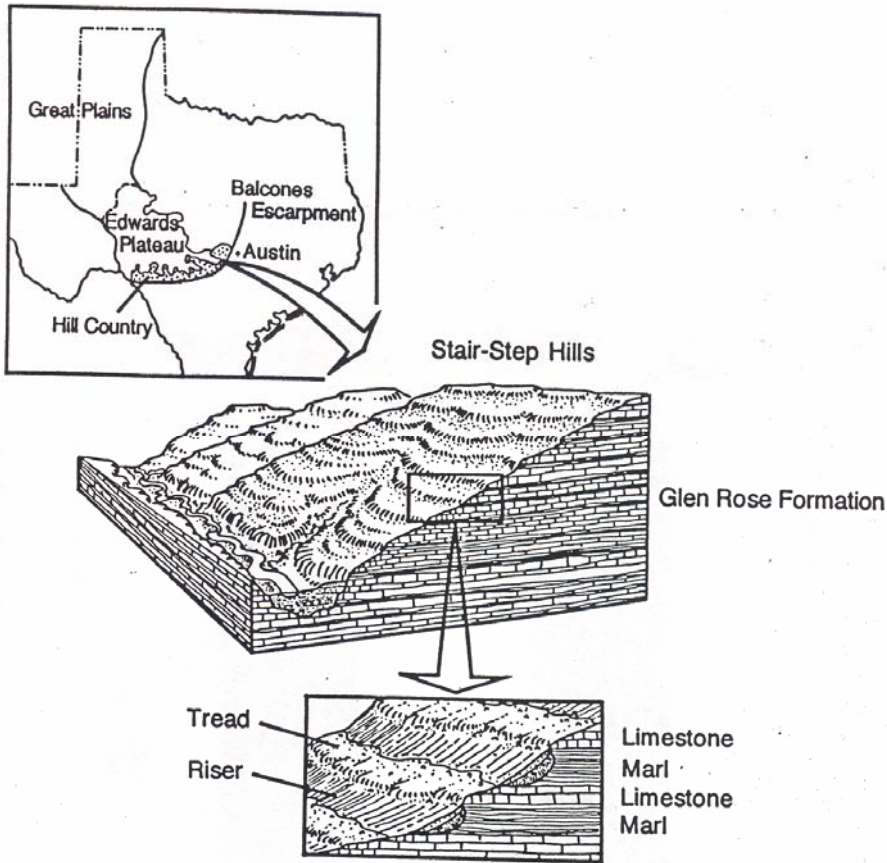

Figure 4-11: Stair-Step Hills of the Glen Rose Formation (Woodruff, 1992)

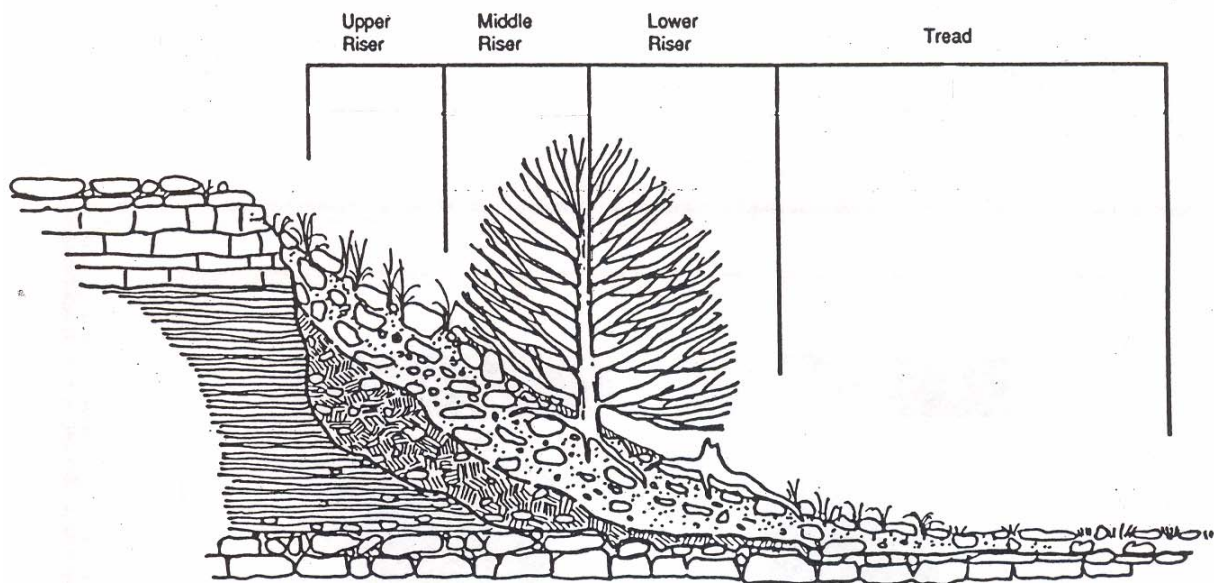

Figure 4-12: Riser/Tread Sequence of Stair-Stepped Topography (Woodruff, 1992)

Application

Filter strips cannot treat high velocity flows, and do not provide enough storage or infiltration to effectively reduce peak discharges to predevelopment levels for design storms. This lack of quantity control restricts their use as a stand-alone BMP to relatively small contributing drainage areas. Filter strips can be used in the following development circumstances:

- Filter strips can be utilized as a stand alone BMP when treating small developments of less than 3 acres (Commercial Alternate Standards) and with a contributing drainage area of less than 3 acres. See Figure 4-13 below;
- Filter strips can be used in conjunction with other structural BMPs such as an extended detention, sand filter, or wet basin by either being placed in series before or after these structural BMPs (See Table 2-9); and
- Filter strips can treat perimeter lots, structures, or roadways of a development that will not drain via gravity to a structural BMP. The use of filter strips to treat perimeter areas is limited to a contributing drainage area of 3 acres and requires the conversion of concentrated flow to sheet flow before entering the strip.

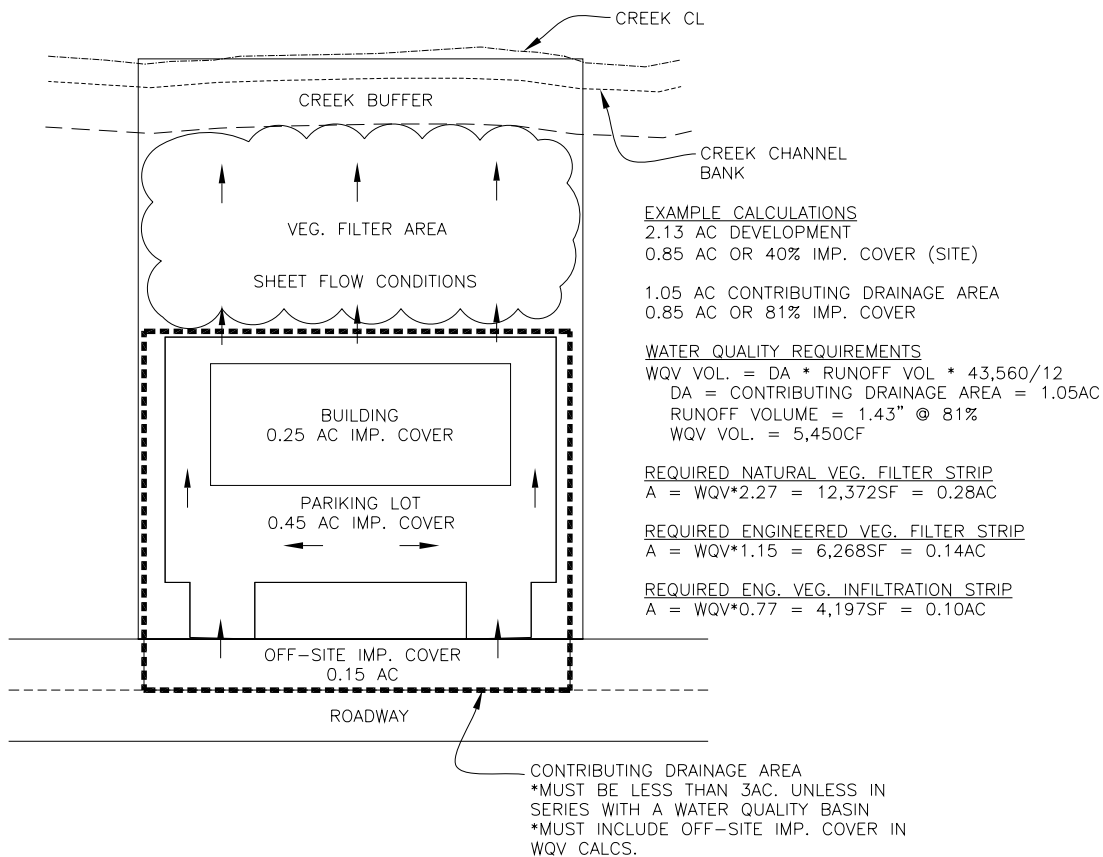

Figure 4-13: Example of Stand Alone Vegetative Filter Strip Application

Design Guidelines

A) Natural Vegetative Filter Strips

(1) *Contributing Drainage Area:* The use of a filter strip as a stand alone BMP should be limited to a contributing drainage area of less than 3 acres. Larger contributing areas are allowed when a filter strip is used in series with a water quality basin such as an extended detention pond, a sand filter, or a wet pond.

(2) *Required Area:*

Stand Alone (Drainage Area. < 3 acres)	$A = WQV * 2.27$
Up-gradient of Extended Detention Pond	$A = WQV * 1.05$
Down-gradient of Extended Detention Pond	$A = WQV * 0.4$
Up-gradient of Sand Filter	$A = WQV * 0.77$
Down-gradient of Sand Filter	$A = WQV * 0.3$
Up-gradient of Wet Pond	$A = WQV * 0.69$
Down-gradient of Wet Pond	$A = WQV * 0.26$

where: $A =$ Required Area (sf)
 $WQV =$ Water Quality Volume calculated per Chapter 2.3

(3) *Slope Restrictions:* No portion of the natural filter area shall exceed a slope of 12%.

(4) *Minimum Dimension in Direction of Flow:* The flow length over the vegetative filter or filter width must be at least 30 feet and no greater than 60 feet to be credited towards the required area. An additional level spreader, infiltration device, or berm may be added for additional length, effectively creating two filter strips in series.

(5) *Upper Boundary Requirements:* The filter strip must run along the entire edge of the contributing area, no collection or routing allowed except following a water quality basin with flow attenuation or discharge from a level spreader to the filter strip. The soil along the upper boundary must be reinforced with protective matting or an infiltration trench (preferred) may be used. Refer to Figure 4.14 below.

(6) *Velocity Restrictions:* Vegetative filter strips are susceptible to erosion and the formation of rills; therefore, may require the use of a flow spreader or an infiltration trench to spread flows and dissipate erosive velocities.

The runoff from the contributing area entering the upper boundary of the filter strip shall be in sheet flow conditions. Sheet flow conditions must meet the following constraints during the peak flow of a 1-yr, 3-hr storm event under fully-developed conditions:

- i. The velocity of flow across the filter strip must not exceed 1 ft/sec.
- ii. The average depth of flow across the filter strip must not exceed 0.2 feet for a vegetative filter strip used in combination with a water quality basin.

$$L = 5Q_{1 \text{ year dev}}$$

L = minimum width of a flow spreader (ft) perpendicular to flow

$Q_{1 \text{ year dev}}$ = Peak flow rate from the 1-yr, 3-hr storm event (See App. 2.4)

- iii. The average depth of flow across the filter strip must not exceed 0.1 feet for a vegetative filter strip used as a stand alone BMP.

$$L = 10Q_{1 \text{ year dev}}$$

L = minimum width of a flow spreader (ft) perpendicular to flow

$Q_{1 \text{ year dev}}$ = Peak flow rate from the 1-yr, 3-hr storm event (See App. 2.4)

- (7) *Surface Characteristics:* The filter area must be free of gullies, rills and flow concentrations and have 70% vegetative cover.
- (8) *Soil Requirements:* The soil must average 4-inches in depth. Rock crop areas may be present but must be deducted from the total filter strip area and must not affect the function of the Vegetative Filter Strip.
- (9) *Terrace Slope Option:* Must be naturally occurring “stair-stepped” topography over the Glen Rose Formation. Required to consist of an overall slope less than 20%, riser slopes may be steeper than 20%, treads should be greater than 4 feet in length with a slope less than 15%. Risers must be stable and capable of functioning as flow spreaders.

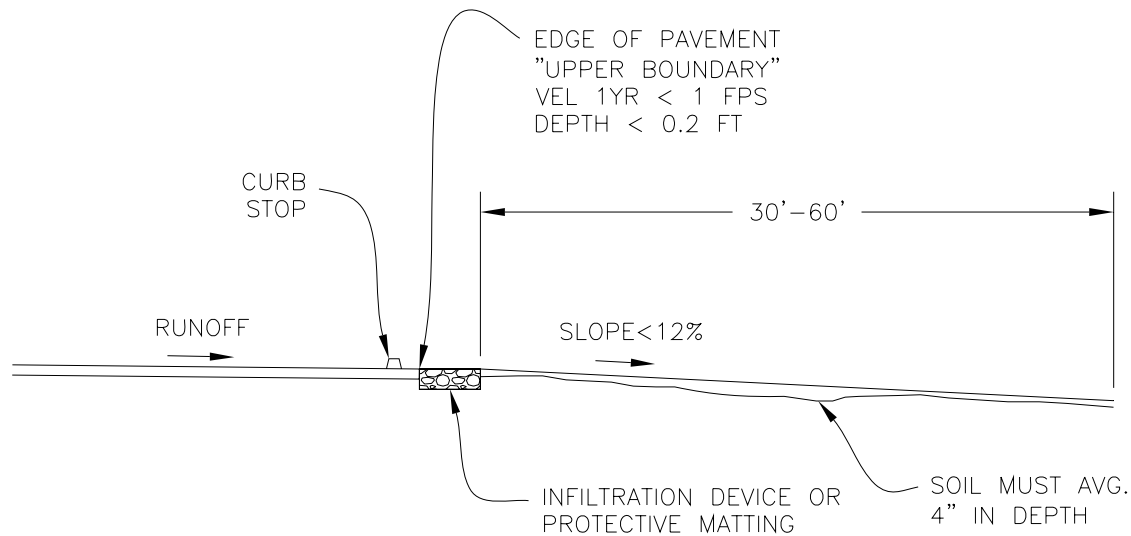

Figure 4-14: Natural Vegetative Filter Strip

B) Engineered Vegetative Filter Strips

(1) *Contributing Drainage Area:* The use of a filter strip as a stand alone BMP should be limited to a contributing drainage area of less than 3 acres. Larger contributing areas are allowed when a filter strip is used in series with a water quality basin such as an extended detention pond, a sand filter, or a wet pond.

(2) *Required Area:*

Stand Alone (Drainage Area < 3 acres)	$A = WQV * 1.15$
Up-gradient of Extended Detention Pond	$A = WQV * 0.53$
Down-gradient of Extended Detention Pond	$A = WQV * 0.2$
Up-gradient of Sand Filter	$A = WQV * 0.39$
Down-gradient of Sand Filter	$A = WQV * 0.15$
Up-gradient of Wet Pond	$A = WQV * 0.35$
Down-gradient of Wet Pond	$A = WQV * 0.13$

where: A = Required Area (sf)
 WQV = Water Quality Volume calculated per Chapter 2

- (3) *Slope Restrictions:* No portion of the filter area shall exceed a slope of 20%.
- (4) *Minimum Dimension in Direction of Flow:* The flow length over the vegetative filter or filter width must be at least 20 feet and no greater than 40 feet to be credited towards the required area. An additional level spreader may be added for additional length, effectively creating two filter strips in series.
- (5) *Upper Boundary Requirements:* The filter strip must run along the entire edge of the contributing area, no collection or routing allowed except following a water quality basin with flow attenuation or discharge from a level spreader to the filter strip. The soil along the upper boundary must be reinforced with protective matting or an infiltration trench (preferred). Refer to Figure 4.15 below.
- (6) *Velocity Restrictions:* Vegetative filter strips are susceptible to erosion and the formation of rills; therefore, may require the use of a flow spreader or an infiltration trench to spread flows and dissipate erosive velocities.

The runoff from the contributing area entering the upper boundary of the filter strip shall be in sheet flow conditions. Sheet Flow conditions must meet the following two constraints during the peak flow of a 1-yr, 3-hr storm event under fully-developed conditions:

- i. The velocity of flow across the filter strip must not exceed 1 ft/sec.
- ii. The average depth of flow across the filter strip must not exceed 0.2 feet for a vegetative filter strip used in combination with a water quality basin.

$L = 5Q_{1 \text{ year dev}}$
 L = minimum width of a flow spreader (ft) perpendicular to flow
 $Q_{1 \text{ year dev}}$ = Peak flow rate from the 1-yr, 3-hr storm event (See App. 2.4)

- iii. The average depth of flow across the filter strip must not exceed 0.1 feet for a vegetative filter strip used as a stand alone BMP.

$$L = 10Q_{1 \text{ year dev}}$$

L = minimum width of a flow spreader (ft) perpendicular to flow

$Q_{1 \text{ year dev}}$ = Peak flow-rate from the 1-yr, 3-hr storm event (See App. 2.4)

- (7) *Surface Characteristics:* The filter area, after final grading, should have a uniform and even slope and be capable of maintaining an even sheet flow across the entire filter surface. The filter area must be free of gullies, rills and flow concentrations. The strip must be sodded or if seed is used it must be accompanied by the appropriate soil blanket or matting per 3.2.11.
- (8) *Soil Requirements:* A minimum of 6-inches of topsoil is required. The topsoil must contain 10-20% compost, a clay content less than 20 percent and be free of stones, stumps, roots or other similar objects larger than one (1) inch. If on-site soils do not meet these specifications, topsoil per the above specs must be added. Sandy loam is not an approved soil and caliche is not considered a soil.
- (9) *Infiltration Berm:* Required at the downgradient end of a filter strip with a slope greater than 2%. The required depth of the infiltration berm is the lesser of $L*s/3$ or 1-foot where “L” is the minimum dimension in the direction of flow and “s” is the average slope of the filter area. Berm side slopes should be no steeper than 3:1, and berm top-width should be 4-8 inches.
- (10) *Terrace Slope Option:* Required to consist of an overall slope less than 20%, riser slopes may be steeper than 20%, treads should be greater than 4 feet in length with a slope less than 15%. Risers must be stable and capable of functioning as flow spreaders.

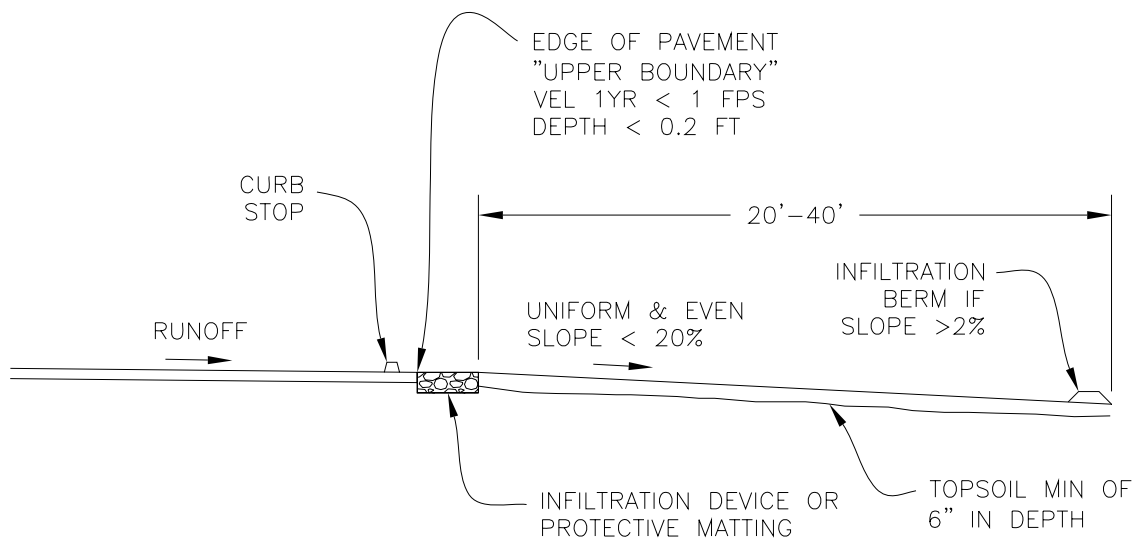

Figure 4-15: Engineered Vegetative Filter Strip

C) Engineered Vegetative Infiltration Strip

(1) *Contributing Drainage Area:* The use of a filter strip as a stand alone BMP should be limited to a contributing drainage area of less than 3 acres. Larger contributing areas are allowed when a filter strip is used in series with a water quality basin such as an extended detention pond, a sand filter, or a wet pond.

(2) *Required Area:*

Stand Alone (Drainage Area < 3 acres)	$A = WQV * 0.77$
Up-gradient of Extended Detention Pond	$A = WQV * 0.35$
Down-gradient of Extended Detention Pond	$A = WQV * 0.13$
Up-gradient of Sand Filter	$A = WQV * 0.26$
Down-gradient of Sand Filter	$A = WQV * 0.10$
Up-gradient of Wet Pond	$A = WQV * 0.23$
Down-gradient of Wet Pond	$A = WQV * 0.09$

where: A = Required Area (sf)
 WQV = Water Quality Volume calculated per Chapter 2

(3) *Slope Restrictions:* No portion of the filter area shall exceed a slope of 10%.

(4) *Minimum Dimension in Direction of Flow:* The flow length over the vegetative filter or filter width must be at least 15 feet and no greater than 60 feet to be credited towards the required area. An additional level spreader, infiltration device, or berm may be added for additional length, effectively creating two filter strips in series.

(5) *Upper Boundary Requirements:* The filter strip must run along the entire edge of the contributing area, no collection or routing allowed except following a water quality basin with flow attenuation or discharge from a level spreader to the filter strip. The soil along the upper boundary must be reinforced with protective matting or an infiltration device (preferred) may be used. Refer to Figure 4.16 below.

(6) *Velocity Restrictions:* Vegetative filter strips are susceptible to erosion and the formation of rills; therefore, may require the use of a flow spreader or an infiltration trench to spread flows and dissipate erosive velocities.

The runoff from the contributing area entering the upper boundary of the filter strip shall be in sheet flow conditions. Sheet Flow conditions must meet the following two constraints during the peak flow of a 1-yr, 3-hr storm event under fully-developed conditions:

- i. The velocity of flow across the filter strip must not exceed 1 ft/sec.
- ii. The average depth of flow across the filter strip must not exceed 0.2 feet for a vegetative filter strip used in combination with a water quality basin.

$$L = 5Q_{1 \text{ year dev}}$$

L = minimum width of a flow spreader (ft) perpendicular to flow

$Q_{1 \text{ year dev}}$ = Peak flow-rate from the 1-yr, 3-hr storm event (See App. 2.4)

- iii. The average depth of flow across the filter strip must not exceed 0.1 feet for a vegetative filter strip used as a stand alone BMP.

$$L = 10Q_{1 \text{ year dev}}$$

L = minimum width of a flow spreader (ft) perpendicular to flow

$Q_{1 \text{ year dev}}$ = Peak flow-rate from the 1-yr, 3-hr storm event (See App. 2.4)

- (7) *Surface Characteristics:* The filter area, after final grading, should have a uniform and even slope and be capable of maintaining an even sheet flow across the entire filter surface. The filter area must be free of gullies, rills and flow concentrations. The strip must be sodded or if seed is used it must be accompanied by the appropriate soil blanket or matting per 3.2.11.
- (8) *Soil Requirements:* A minimum of 12-inches of topsoil is required. The topsoil must contain 10-20% compost, 20-30% sand or granite sand and 50-60% topsoil, of which total clay content must be less than 20 percent and be free of stones, stumps, roots or other similar objects larger than one (1) inch. If on-site soils do not meet these specifications, topsoil per the above specs must be added. Sandy loam is not an approved soil and caliche is not considered a soil.
- (9) *Infiltration Berm:* Required for slopes greater than 1%. The top of each berm should be 0.1 feet below the uphill edge of the strip or the base of the preceding berm. Berm side slopes should be no steeper than 3:1, and berm top-width should be 4-8 inches. Standard design will be one or more berms placed downgradient at intervals of 15 feet, other designs will be acceptable if they maintain equivalent infiltration area and ponding volume.

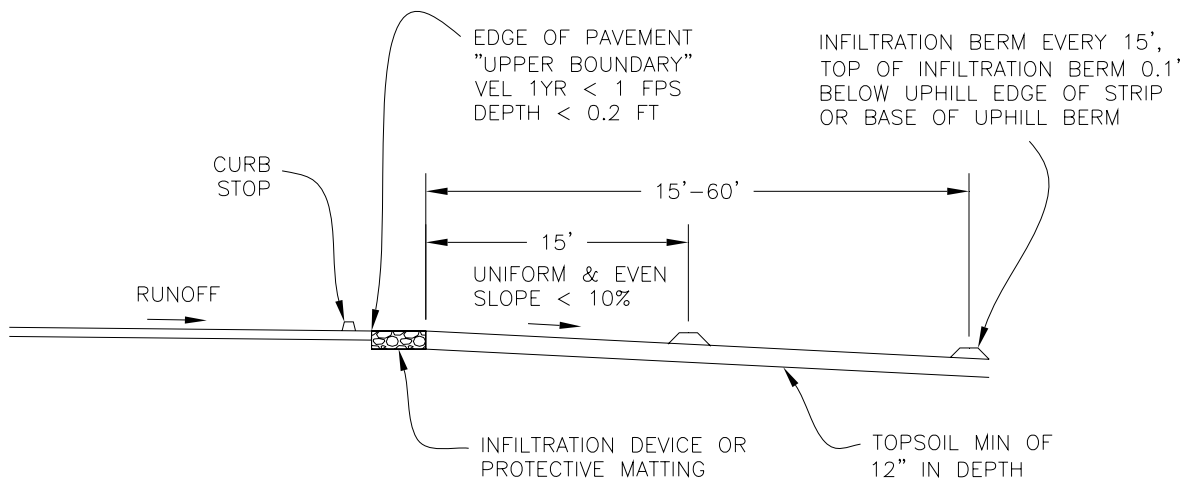

Figure 4-16: Engineered Vegetative Infiltration Strip

4.2.8 Stormwater Infiltration Devices

Description

Stormwater infiltration devices capture and temporarily store stormwater runoff while allowing infiltration into the soil over a prescribed period. The natural filtering ability of the soil is used to remove pollutants in stormwater runoff. This practice has high pollutant removal efficiency, reduces runoff volume and can also help recharge groundwater, thus helping to maintain stream flows.

This section presents two options for stormwater infiltration; an infiltration basin and an infiltration trench. An infiltration basin is a shallow impoundment that is designed to infiltrate stormwater while an infiltration trench is a long, narrow, rock-filled trench where runoff is stored in the void space between the stones and infiltrates through the bottom and into the soil matrix.

Application

Stormwater infiltration requires pre-treatment of runoff and will primarily be used as a secondary treatment process to obtain compliance with the Highland Lake Watershed Ordinance. Stormwater infiltration can also be used as a flow spreader device for stormwater runoff. Soil infiltration rates and the water table depth should be evaluated to ensure that conditions are satisfactory for proper operation of an infiltration device. Stormwater infiltration devices may not be suitable for fill sites, for steep slopes, and for industrial sites or locations where spills may occur. Maintenance and longevity of infiltration devices due to clogging is a major concern; therefore, the device should be located downstream of a water quality basin. Other construction requirements include:

- (1) Before site is graded, locate infiltration systems during site surveying, mark, and prevent all traffic and heavy equipment from entering the area to prevent compaction of soils.
- (2) Once the practice is excavated, the contractor shall contact LCRA for an inspection with the contractor and designer. They will evaluate trench, soils, and verify that no objects such as roots protrude into the practice.
- (3) To ensure that sediment from the construction phase does not enter the infiltration practice, diversion berms shall be placed around the perimeter of the device throughout construction until upstream areas are stabilized, sediment and erosion control plans should be developed to keep sediment and runoff away from the area, and the upstream drainage area must be completely stabilized before the device may receive runoff. Since infiltration is primarily a secondary BMP, upstream BMPs must be sodded to limit soil discharge to the practice.
- (4) Infiltration areas must not be used as temporary sediment basins during construction.
- (5) Infiltration practices should be excavated using light earth-moving equipment with tracks or over-sized tires. Bull dozers should be avoided.

- (6) Excavated material must be placed at least 15 feet from the infiltration area and protected to prevent sediment discharge to device.
- (7) Since some compaction of the underlying soils is still likely to occur during excavation, the floor of the device should be tilled or scarified.
- (8) Trenches should be covered and not put into operation until the contributing drainage area is completely stabilized and all pretreatment BMPS are installed.

Infiltration practices should be located at least 100 feet away from a water supply well and at least 12 feet down-gradient from any building foundations. Additionally, they should be set back at least 50 feet from on-site wastewater systems, especially drain fields.

Design Guidelines

A. Infiltration Basins

- (1) *Pretreatment:* Required, infiltration basins must be the second BMP in series, located down gradient of a water quality basin.
- (2) *Soil Requirements:* A subsoil infiltration rate between 0.3-5.0 in/hr is required. At least three (3) feet of soil separation is required between the basin invert or underdrain. There must be a three (3) foot separation between the BMP invert and the high water table and greater than one (1) foot of soil between bedrock and the BMP invert. At least one soil boring or test hole per 5,000 square feet is required to observe soil properties and depth to water table and bedrock. The infiltration rate should be determined using one of the following:
 - (a) Infiltrometer testing using a double ring infiltrometer (ASTM D 3385-94) or percolation test.
- (3) *Basin Sizing:* The required infiltration basin volume is determined from the type of upstream water quality basin and the calculated Water Quality Volume (WQV).

Extended Detention: $V_{IB} = WQV * 0.058$

Sand Filter: $V_{IB} = WQV * 0.044$

Wet Pond: $V_{IB} = WQV * 0.042$

V_{IB} = Required Volume for Infiltration Basin (cf)

WQV = Required Water Quality Volume (cf) (as calculated according Chapter 2.3)

- (4) *Basin Configuration:* The basin should be designed as an off-line facility. The floor of the basin should be graded as flat as possible to permit uniform ponding and infiltration. Low spots and depressions should be leveled out. There are no restrictions on the shape or size of the basin.

(5) *Depth of Basin:*

<u>Soil Investigation Average k (in/hr)</u>	<u>Maximum Ponding Depth (ft)</u>
Less than 0.30	Not Permitted
0.30 to 0.49	0.8
0.50 to 0.69	1.2
0.70 to 0.89	1.6
0.9 and higher	2.0

k is hydraulic conductivity of soil

(6) *Overflow Conveyance:* Basin required to convey the peak inflow.

(7) *Overland Runoff:* Divert overland runoff from project site around basin through the use of an embankment or overflow berm.

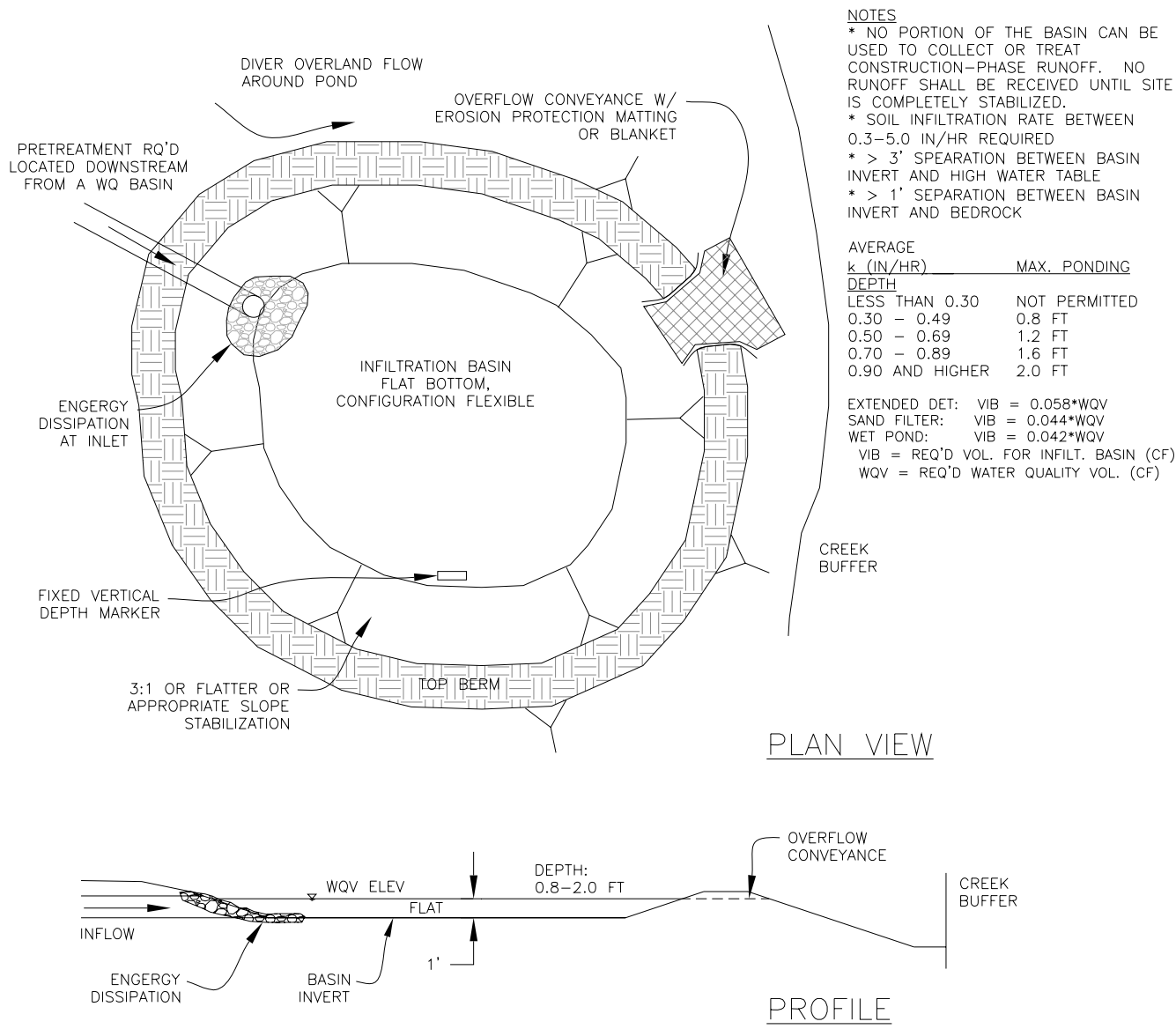

Figure 4-17: Infiltration Basin Schematic

B. Infiltration Trench

- (1) *Pretreatment:* Required, infiltration trenches must be the second BMP in series, located downstream of a water quality basin.
- (2) *Soil Requirements:* A subsoil infiltration rate between 0.3-5.0 in/hr is required. There must be a three (3) foot separation between the trench invert and the high water table and greater than one (1) foot of separation between bedrock and the BMP invert. At least one soil boring or test hole per 1,000 square feet required to observe soil properties and depth to water table and bedrock. The infiltration rate should be determined using one of the following:
 - (a) Infiltrometer testing using a double ring infiltrometer (ASTM D 3385-94) or percolation test.
- (3) *Trench Sizing:* The required infiltration trench volume is determined from the type of upstream water quality basin, the calculated Water Quality Volume (WQV) and the hydraulic conductivity of soil. A porosity value “n” ($n=V_v/V_i$) of 0.35 should be used in the design of stone reservoirs for infiltration practices.

Extended Detention: $V_{IT} = WQV * 0.03 * (1-VR\%)$

Sand Filter: $V_{IT} = WQV * 0.023 * (1-VR\%)$

Wet Pond: $V_{IT} = WQV * 0.023 * (1-VR\%)$

When an infiltration trench is used in combination with a vegetated filter strip, the **infiltration trench length in feet** is computed per the following. The infiltration trench cross sectional area must be at least 8 square feet.

Extended Detention: $V_{IT} = WQV * 0.006 * (1-VR\%)$

Sand Filter: $V_{IT} = WQV * 0.0045 * (1-VR\%)$

Wet Pond: $V_{IT} = WQV * 0.0043 * (1-VR\%)$

V_{IT} = Required Volume for Infiltration Trench (cf) (void volume)

WQV = Required Water Quality Volume (cf) (as calculated according Chapter 2.3)

VR% = Volume Reduction % (see table below)

Infiltration Trench Volume Reduction Percentage

Soil Investigation Average k (in/hr)	VR% Infiltration Trench Volume Reduction %
Less than 0.30	Not Permitted
0.30 to 0.49	0%
0.50 to 0.69	24%
0.70 to 0.89	39%
0.90 to 1.09	49%
1.10 to 1.29	56%
1.30 to 1.49	62%
Greater than 1.5	65%

- (4) *Trench Configuration:* Ratio of required infiltration volume to infiltration surface area (V_{IT}/A_i) should be no greater than 1.0 and preferably less. Infiltration surface area includes the invert and walls of the trench. The trench should be less than 8 feet deep. Infiltration trenches in parallel must be separated by a distance equal to twice the trench depth. Infiltration trench overflow must be located along a contour and will serve as an excellent flow spreading device.
- (5) *Trench Backfill:* The backfill should consist of 1.5-3 inch washed bank run gravel aggregate with no fines. If the underlying soils have more than 40% silt and clay then a 6-inch sand layer is recommended as a bottom filter layer. Filter fabric is required on the bottom and sides of trench and below the top three inches of the trench to minimize soil movement into trench and facilitate maintenance. Non-woven 4 oz. geotextile fabric is required to separate gravel and sand from adjacent soil and layers.
- (6) *Overflow Conveyance:* A conveyance system should be included in the design in order to ensure that excess flow from the trench is discharged at non-erosive velocities.
- (7) *Discharge Pipe:* The discharge pipe into the trench should be located at 1/2 the trench depth, i.e. if the trench is four feet deep, then the discharge pipe is placed two feet below the top of trench elevation.
- (8) *Overland Runoff:* Divert overland runoff from project site around trench through the use of an embankment , swale, or overflow berm.
- (9) *Maintenance Requirements:* Two observation wells are required, recommend 6” perforated PVC with cleanout. See Chapter 5 for Maintenance Plan requirements. If trench exceeds 100 feet in length, then add one additional observation well for every 100 feet of trench length.

NOTES

- * NO PORTION OF THE TRENCH CAN BE USED TO COLLECT OR TREAT CONSTRUCTION-PHASE RUNOFF. NO RUNOFF SHALL BE RECEIVED UNTIL SITE IS COMPLETELY STABILIZED.
- * SOIL INFILTRATION RATE BETWEEN 0.3-5.0 IN/HR RQ'D
- * > 3' SEPARATION BETWEEN BASIN INVERT AND HIGH WATER MARK
- * > 1' SEPARATION BETWEEN BASIN INVERT AND BEDROCK

INFILTRATION TRENCH VOL (CF)

- EXTENDED DET.: $VIT = 0.03 * WQV * (1 - VR\%)$
- SAND FILTER: $VIT = 0.023 * WQV * (1 - VR\%)$
- WET POND: $VIT = 0.023 * WQV * (1 - VR\%)$
- $VIT = RQ'D \text{ VOL. FOR INFILTRATION TRENCH (CF) (VOID VOL.)}$
- $WQV = RQ'D \text{ WATER QUALITY VOLUME (CF)}$
- $VR\% = \text{VOLUME REDUCTION \% (SEE TABLE THIS SECTION)}$

INFILTRATION TRENCH CONFIGURATION

- $VIT/A_i < 1$
- $VIT = RQ'D \text{ VOL. FOR INFILTRATION TRENCH (CF)}$
- $A_i = \text{INFILT. SURFACE AREA INCLUDES WALLS \& INVERTS (SF)}$

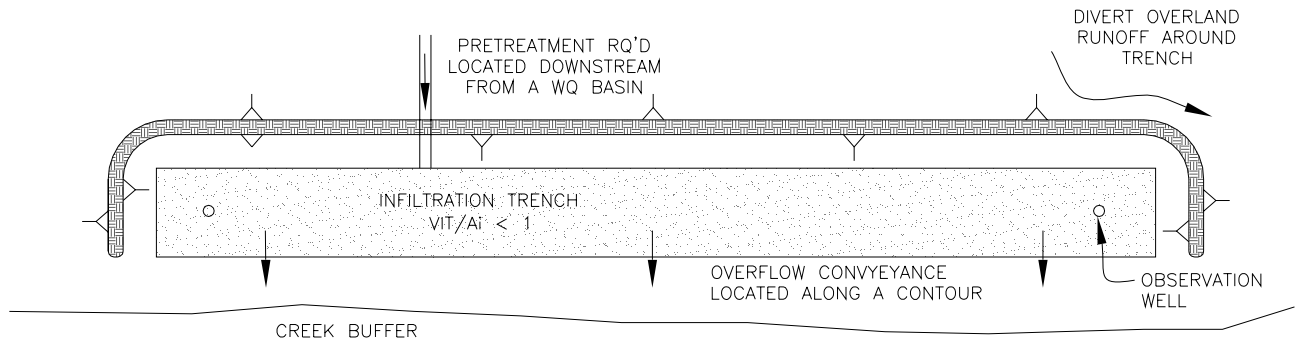

PLAN VIEW

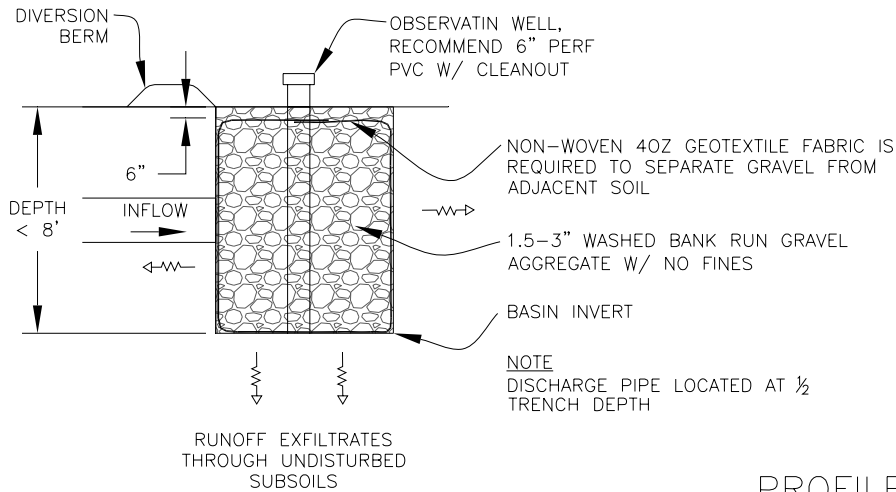

PROFILE

Figure 4.18: Infiltration Trench Schematic

4.3 *Stormwater Credits*

The stormwater basin sizing criteria provides a strong incentive to reduce impervious cover at development sites, since significant reductions in impervious cover will result in less costly water quality basins and in some cases gain compliance with alternate development standards. The techniques presented in this section are considered options to be used by the designer to reduce the need for stormwater BMP storage capacity. Due to local codes, soil conditions, and topography, some of these site design features will be restricted. Designers are encouraged to consult with the LCRA to determine stormwater credit restrictions. In single-family subdivisions, stormwater credits will most likely be accrued on single-family lots. Since these activities will be constructed by homebuilders and not the developer, the stormwater credit will require easements, deed restrictions, fiscal security, or other articles approved by LCRA in the permitting process to ensure the proper installation, maintenance, and survivability. Below, a description is provided for each credit, including minimum criteria to be eligible for the credit, an example credit calculation, and design/construction specifications.

4.3.1 Porous Pavement/Pervious Pavers Credit

Definition of Porous Pavement/Pavers Credit

A credit is given when porous pavement and/or paver blocks are utilized in driveways, streets, sidewalks, and parking lots to reduce the development impervious cover. If the porous pavement or pavement blocks are constructed per the guidance in this manual, then a factor dependent upon the pavement type is applied to reduce the impervious cover. This credit can be used to gain compliance with the Alternate Standards or reduce the BMP volume. The credit is calculated per the equations below. Design and construction details can be found in this section and Appendix 2.10.1.

Porous pavement credit is computed per the following:

$$A_r = A_p * 0.90$$

Where: A_r = Allowable reduction in impervious cover
 A_p = Area of porous pavement

Pervious Pavers credit is computed per the following

$$A_r = A_p * \%_0 * 0.75$$

Where: A_r = Allowable reduction in impervious cover
 A_p = Area of porous pavement
 $\%_0$ = Percent open space of the paver system

Restrictions on the Credit

The porous pavement/pavers credit is subject to the following restrictions:

- Porous pavement must satisfy the design and installation requirements in this Section. Porous Pavers must satisfy manufactures specifications;
- A pavement/paver maintenance plan must be approved by LCRA before issuance of a development permit; and
- The development permit will include a condition that the contractor must contact LCRA 48 hours prior to the placement of the porous pavement.

Example calculation, the required water quality volume before the credit for a ten (10) acre site with 30 single family lots would be:

Impervious cover = 3 acres = 30%

1-year runoff volume = 0.59 inches based on Equation 2.9

Water quality volume = (0.59 inches) * (10 acres) * (43,560/12) = 21,417 cubic- feet

Applying the credit, each single family lot has a driveway length of 35 feet and a width of 16 feet for a total driveway area of 560 square feet. The designer chooses to use porous concrete pavement for each driveway. Thus, the driveway area impervious cover is reduced by 90%.

Driveway area = 560 square feet

A_r = Allowable reduction in impervious cover per house = (560) * (0.90) = 504 sq. feet

Impervious Cover with Credit = (3 acres) – ((30 lots) * (504 sq. ft))/43,560 = 2.65 acres

Effective impervious cover = 27%

1-year runoff volume = 0.54 inches based on Equation 2.1

Water quality volume = (0.54 inches) * (10 acres) * (43,560/12) = 19,602 cubic-feet.

The BMP water quality volume is reduced by 8% in this example.

Description

Permeable concrete consists of concrete that is made without the fine (sand) fraction. Eliminating the sand increases the permeability, but greatly reduces the strength. Several manufacturers produce additives to increase the strength so that it is comparable to that achieved with a standard concrete mix. The lack of sand fraction also has the effect of substantially shortening the time for the concrete to setup and may make it difficult to get a consistent texture. Anyone considering this material should have highly detailed specifications and ensure that an experienced contractor is used to minimize potential problems.

The term describes a system comprising a load-bearing, durable concrete surface together with an underlying layered structure that temporarily stores water prior to infiltration or drainage to a controlled outlet. Attenuation of flow is provided by the storage within the underlying structure or sub-base, together with appropriate flow controls. An underlying geotextile layer may permit groundwater recharge where sufficient soil depth exists, thus contributing to the restoration of the natural water cycle. Alternatively, where infiltration

is inappropriate (e.g. if the groundwater vulnerability is high, or the soil type is unsuitable), the installation can be constructed with an underdrain.

Application

The use of permeable concrete is encouraged under the Highland Lakes Watershed Ordinance in the form of a porous pavement credit, which provides for a reduced impervious cover of 90% for the area treated with this surface.

Porous pavement may be used for light vehicle loads in parking lots or for sidewalks in the Highland Lakes watershed. Permeable concrete areas should be constructed so that runoff from adjacent areas such as landscaping, rooftops, etc. is directed away from the permeable pavement.

Design Guidelines

There are two possible configurations of permeable concrete: with and without an underdrain. Systems constructed with an underdrain should include a layer of sand to filter the stormwater prior to surface discharge. This type of system does not require an impermeable liner and should be designed and constructed to retain as much of the sites predevelopment infiltration capability as possible. Effluent from an underdrain system should be treated with vegetated strips or a structural BMP system.

Permeable concrete systems without an underdrain treat stormwater runoff via filtration assuming adequate infiltration capacity of underlying soils.

(1) *Materials:*

- i. *Cement:* Portland Cement Type I or II conforming to ASTM C 150 or Portland Cement Type I P or IS conforming to ASTM C 595.
- ii. *Aggregate:* Use Texas Department of Transportation (TxDOT) grade No. 8 coarse aggregate (3/8 to No. 16) per ASTM C 33; or No. 89 coarse aggregate (3/8 to No. 50) per ASTM D 448.
- iii. *Admixtures:* Optional.
- iv. *Water:* Potable or should comply with TxDOT Standard Specifications.
- v. *Base Material:* The design of the water quality functions of the pavement system depends on adequate storage volume within the base material. The gravel layers should consist of clean, durable, uniformly graded rock meeting the ASTM C-33 specifications for No. 4 aggregate. The sand layer in systems with an underdrain should meet ASTM C-33 specifications for fine aggregate.

(2) *Proportions:*

- i. *Cement Content:* For pavements subject to vehicular traffic loading, the total cementitious material shall not be less than 564 lbs. per cubic yard.
- ii. *Aggregate Content:* The volume of aggregate per cubic yard shall be equal to 27 cubic feet when calculated as a function of the unit weight determined in accordance with ASTM C 29 jigging procedure.
- iii. *Admixture:* Optional for strength.
- iv. *Mix Water:* Mix water quantity shall be such that the cement paste displays a wet metallic sheen without causing the paste to flow from the aggregate. (Mix water quantity yielding a cement paste with a dull-dry appearance has insufficient water for hydration.)

Insufficient water results in inconsistency in the mix and poor aggregate bond strength. High water content results in the paste sealing the void system primarily at the bottom and poor aggregate surface bond.

(3) *Recommendations for Permeable Concrete with Underdrain and Surface Discharge:*

- i. *Base material:* Should consist of the materials and configuration shown in Figure 4.19. The thickness of the concrete should be sufficient to bear expected loads.
- ii. *Lateral Flow Barriers:* Lateral flow barriers should be installed using a liner of Polyethylene (PE) or PVC that is at least 16 mils thick normal to the direction of flow to prevent flow of water downstream and then surfacing at the toe of the permeable pavement installation. The maximum distance (L_{max}) between cutoff barriers should not exceed that shown in Figure 4.19.
- iii. *Geotextile Fabric:* The sand and gravel layers should be separated by a layer of non-woven 4oz. geotextile fabric. The purpose of the fabric is to prevent migration of fine material from the sand layer into the gravel. Geotextile fabric must overlap a minimum of 18 inches.
- iv. *Underdrain Piping:* The underdrain pipe should consist of 3 to 4 inch diameter Schedule 40 PVC. Perforations should be 3/8 inches in diameter and maximum spacing between perforations should not exceed six inches. Alternatively the underdrain piping described in Section 4.2.1 under General Guidelines Item No. 8 may be used.

- v. *Impermeable Liner:* An impermeable liner is provided only in the bottom of the underdrain trench when required to provide a flow barrier for installations that are not level.
- vi. *Subsoil:* The subsoil must be natural soil without waste, debris, or material that might leach chemicals into the subsurface. If fill material is required below the pavement, it must be clean and free of deleterious material. It must meet all geotechnical specifications for structural support.

(4) *Recommendations for Permeable Concrete without Underdrain:*

- i. *Base Material:* Base material must consist of clean, durable, ASTM C-33 No. 4 aggregate 8 inches thick composed of 1-1/2 to 2 inch clean aggregate (no fines).
- ii. *Geotextile Fabric:* A layer of non-woven 4oz. geotextile fabric is to be placed on top of the natural subsoil prior to placing base material. The fabric should extend up the natural earth sides and over the top of any adjacent berm. The purpose of the fabric is to prevent migration of fine material from the subsoil into the gravel.
- iii. *Subsoil:* Soil exploration should demonstrate a minimum of 12 inches of subsoil below the base material at every sample location. Soil tests must be conducted on the greater of 2 samples for each identified soil type, or 1 sample per 5,000 square feet of infiltration area. The subsoil must be natural soil without waste, debris, or material that might leach chemicals into the subsurface. If fill material is required below the pavement, it must be clean and free of deleterious material and have a texture comparable to natural soil at the site. Rocky soils are acceptable; however, the coarse material (diameter greater than 0.5 inches) should not account for more than 30% of the soil volume of either soil or fill material.

The subgrade must not be compacted or subjected to construction vehicle traffic prior to the placement of base. Subgrade work must be sequenced to minimize passes of construction vehicles in the beds themselves. If the excavated subgrade is exposed to rainfall runoff, it may accumulate fines. These must be removed prior to geotextile fabric and base placement. Grading should not occur during wet soil conditions to minimize smearing and sealing of the soil surface. If such sealing occurs, the surface must be scarified to restore natural texture and permeability.

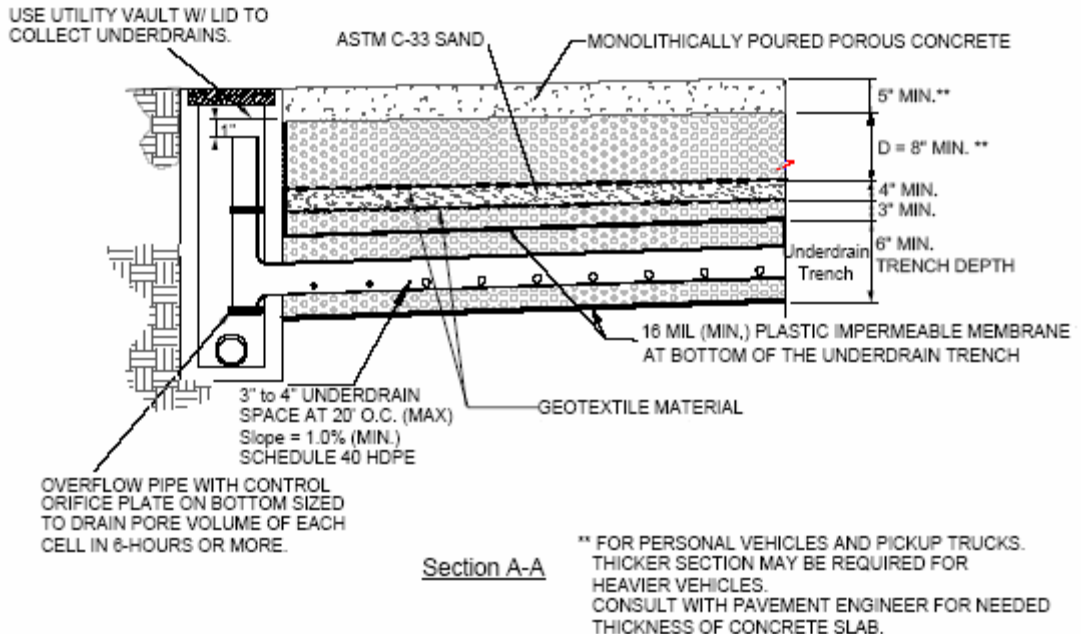
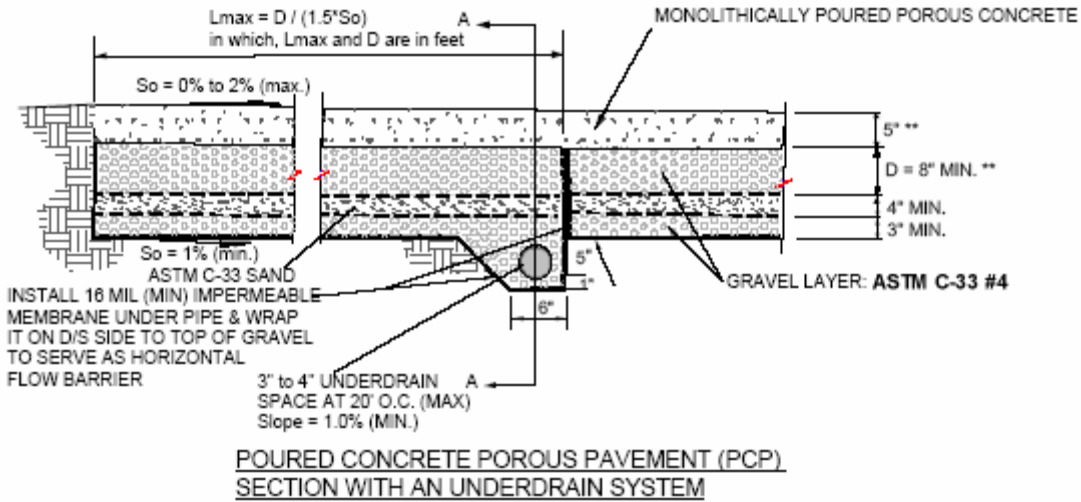

Figure 4.19: Schematic of Permeable Concrete with Underdrain Installation (after UCFCD, 2004)

4.3.2 Rainwater Harvesting/Cistern Credit

Definition of Rainwater Harvesting/Cistern Credit

A credit is given when rainwater collection systems are used to retain roof runoff resulting in the reduction of the development impervious cover. Rainwater collection systems will generate an impervious cover reduction for the area that drains to the rainwater collection barrel(s) based on the ratio of the barrel volume to the roof (catchment) area. Rainwater collection can occur at single family residences, multi-family complexes, and commercial developments. This credit can be used to gain compliance with the Alternate Standards or reduce the water quality volume. The maximum impervious cover reduction is 75% to account for rainwater system maintenance and operation challenges that may occur over the system life.

Rainwater collection can also be used to satisfy the roof-top disconnection credit, but can not be counted as a credit for both rainwater harvesting and roof-top disconnection.

Reduced impervious cover credit is computed per the following equation and figure:

Where:

$$A_r = A_{RT} * \%IC \text{ REDUCTION FACTOR (per Figure below)}$$

A_r = Allowable reduction in impervious cover
 A_{RT} = Area of roof-top directed to rain barrel(s) (catchment area) (sq ft)
 $\% IC \text{ REDUCTION FACTOR}$ = % Impervious area reduction
 RBV = Rain barrel volume (cubic feet)

Rainwater Harvesting Effectiveness

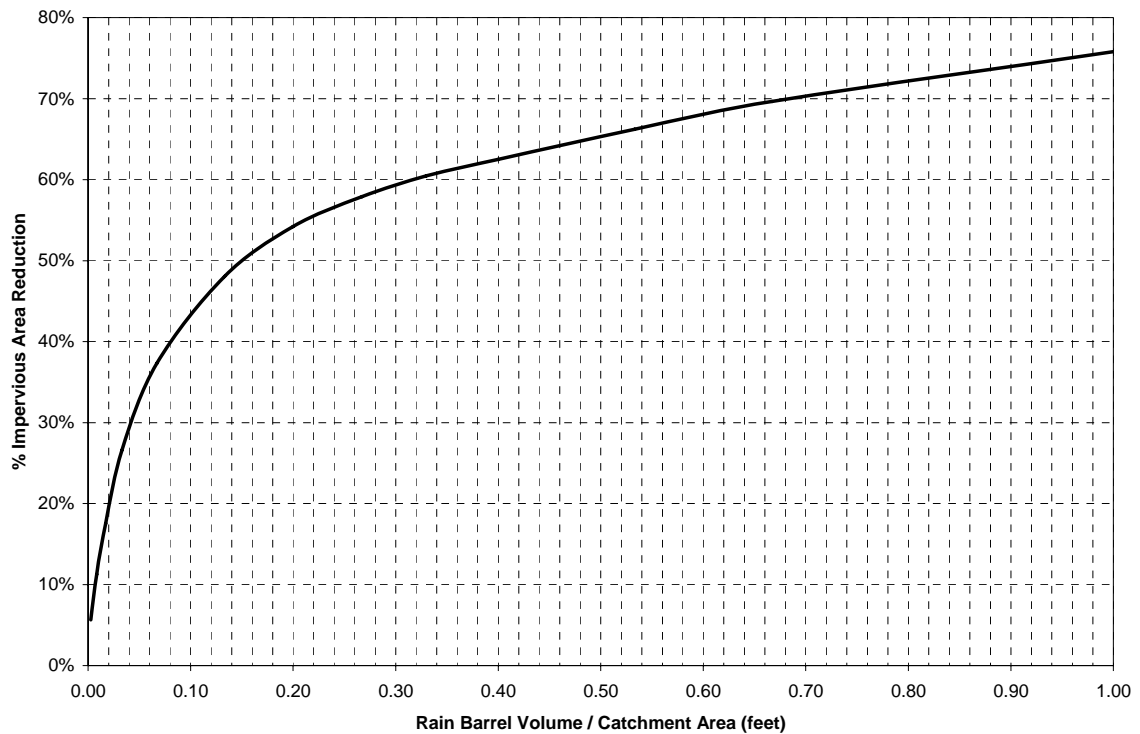

Rainwater Collection Credit

Restrictions on the Credit

The rainwater harvesting credit is subject to the following restrictions:

- Rainwater collection and distribution systems must be designed and installed per the requirements in this Section;
- A rainwater collection system maintenance plan must be approved by LCRA before issuance of a development permit. The maintenance plan will need to identify the responsible maintenance party and allow for periodic LCRA inspection;
- The development permit will include a condition that the contractor must contact LCRA 48 hours prior to the final completion of the rainwater collection system;
- Storage shall be provided in cisterns, rain barrels, tanks, or other approved methods.
- Overflows from rainwater tanks should be diverted to grassy swales and/or lawns to promote infiltration of excess runoff volume.

Example calculation, the required water quality volume before the credit for a ten (10) acre site with 30 single family lots would be:

Impervious cover = 3 acres = 30%

1-year runoff volume = 0.59 inches based on Equation 2.9

Water quality volume = (0.59 inches) * (10 acres) * (43,560/12) = 21,417 cubic- feet.

Applying the credit, each single family lot will utilize a rainwater collection system per the criteria. Each house has a roof area of 2,000 square feet, however, individual roof design is not known at this phase, thus a factor of 0.75 is applied to the roof area, resulting in the assumption that 1,500 square feet can be drained to rainwater collection tanks. The home storage barrel(s) will provide 1,500 gallons of storage.

Roof area draining to collection barrels = 2,000 square feet * 0.75 = 1,500 square feet

Barrel volume = 1,500 gallons per plat note and deed restriction = 200 cubic feet

Barrel volume to catchment area = 200 / 1,500 = 0.13

Using the Rainwater Harvesting Effectiveness Figure, % IC Reduction = 43%

A_r = Allowable impervious cover reduction per house = (1,500) X (0.43) = 645 square feet

Impervious cover with credit = (3 acres) – ((30 lots) * (645 sq. ft)) = 2.56 acres

Effective impervious cover = 26%

1-year runoff volume = 0.52 inches based on Equation 2.9

Water quality volume = (0.52 inches) * (10 acres) * (43,560/12) = 18,876 cubic-feet.

The BMP water quality volume is reduced by 12% in this example.

Description

Rainwater harvesting is a method of diverting and collecting rainfall that falls onto impervious surfaces, such as roofs. Harvested rainfall is typically used for indoor residential use, landscape irrigation, or both. By capturing and slowly releasing rooftop runoff over vegetated areas, rainwater harvesting can reduce stormwater volume and flow rates and the resultant erosion and pollutant discharges to surface waters. Schematics of a complex rainwater harvesting system are presented in Figures 4.21 and 4.22 below.

Application

In a rooftop rainwater harvesting system, runoff flows via gravity through gutters and downspouts into a storage tank where it is slowly released to landscaped areas or stored for later use. Rainwater harvesting systems are primarily designed for conservation—long-term storage and use—rather than to mitigate the impacts of impervious cover and increased runoff. If a tank is full or near-full (beneficial for conservation and long-term use) it will not provide stormwater benefits.

Rainwater harvesting systems can provide pretreatment for other BMPs and qualify for stormwater credit to reduce water quality basin size or gain compliance with the Alternate Standards. The collection systems are equally appropriate in large-scale landscapes, such as parks, schools, commercial sites, parking lots and apartment complexes and in small residential landscapes. Rainwater harvesting is a feasible alternative for intensively developed areas and is suitable for steep terrain and flat landscapes where collected water can be diverted to depressed landscaped areas or grassy swales.

Rooftop rainwater harvesting provides a lower-cost method of treating surface water runoff than other permanent water quality treatment structures. Costs include the storage tank, filtering system, and pressure pump. Routine maintenance is a minor expense but is essential for the system to properly function. In an effort to encourage water conservation, the State provides financial incentives and tax exemptions to offset the equipment costs. Municipal incentives are also available in some areas.

Additional information can be found in the Texas Rainwater Harvesting Manual.

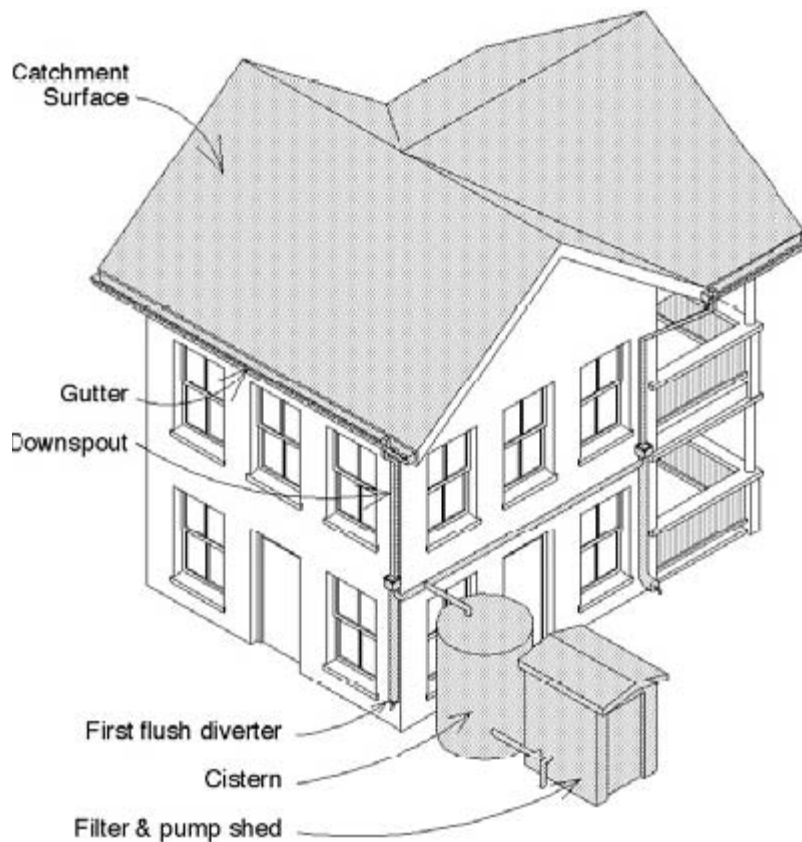

Figure 4.20: Complex water harvesting system with roof catchment, gutter, downspout and storage tank. (City of Austin Energy's Green Building Fact Sheet, 1995)

Design Guidelines

Rainwater Harvesting is a system of collecting, conveying, and storing rainfall from impervious surfaces and directing water to where it is needed.

- (1) *Catchment surface:* The collection surface is the “footprint” of the roof. The effective collection surface is the length times the width of the roof from eave to eave and front to rear.
- (2) *Conveyance systems:* Gutters should be properly sized and located to maximize catchment efficiency and prevent overrunning. Overrunning can result from an inadequate number of downspouts, excessively long roof distances from ridge to eave, steep roof slopes, and inadequate gutter maintenance. Preventative strategies may include modifications to the size and configuration of gutters and addition of gutter boxes with downspouts and roof diverters near the eave edge. Gutters should slope towards the downspout with the outside face of the gutter lower than the inside face to encourage drainage away from the building wall. Downspouts should provide 1 square inch of downspout opening for every 100 square feet of roof area. The first flush runoff should outfall onto an adequately sized rock splash pad that will prevent erosion, channeling, or puddling.

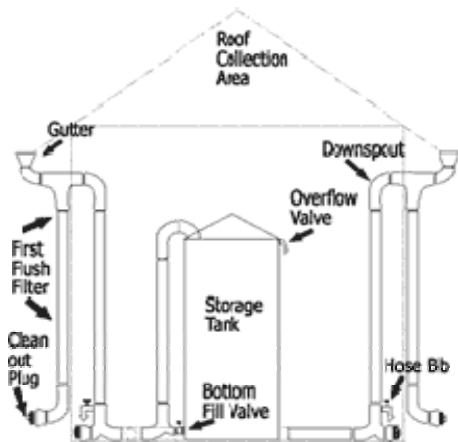

Figure 4.21: Complex water harvesting system with roof catchment, gutter, downspout and storage tank. (City of Austin Energy’s Green Building Fact Sheet, 1995)

- (3) *Storage:*
 - i. *Filtration:* Leaf screens, first-flush diverters, and roof washers should be installed on inflow lines to prevent trash and organics from entering the storage area. Permanent openings must be screened to prevent insect infestation in the piping and standpipe.

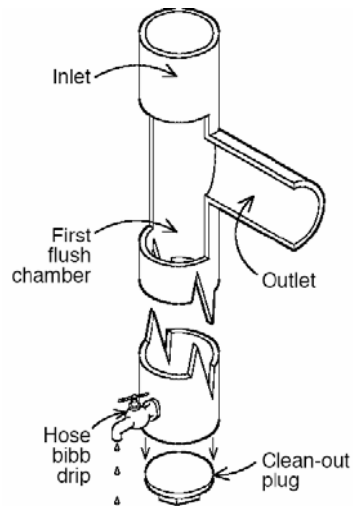

Figure 4.22: Standpipe first flush diverter. The recommended diversion of first flush ranges from one to two gallons of first-flush diversion for each 100 square feet of collection area. (TWDB, 2005)

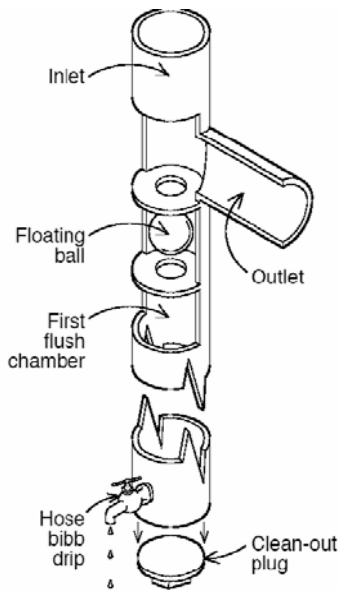

Figure 4.23: Standpipe with ball valve. The standpipe with ball valve is a variation of the standpipe filter. As the chamber fills, the ball floats up and seals on the seat, trapping first-flush water and routing the balance of the water to the tank. (TWDB, 2005)

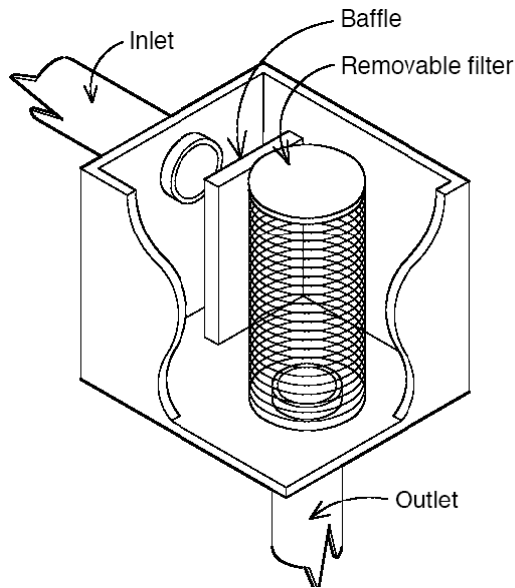

Figure 4.24: Box roof washer. Roof washers are recommended for drip irrigation systems. (TWDB, 2005)

- (4) *Delivery system:* The distribution directs water to plants from storage tanks to garden hoses, constructed (non-erosive) channels, or manual drip systems. Drip and other types of integrated distribution systems may require a small pressure pump to distribute the water. If a drip irrigation system is not used, the water can gravity-flow to garden hoses. In addition, the water can be delivered to the house for domestic use.
- (5) *Stormwater Credits:* Stormwater credit is given when rooftop runoff is collected, stored per the volume requirements, and discharged through everyday consumption. The figure above illustrates the percentage of impervious cover reduction that can be obtained using the above listed criteria. The percentage of impervious cover reduction is based upon the percentage of rooftop runoff that is captured. A maximum reduction of 75% of the rooftop impervious cover will be given. Credit is documented at the concept plan stage. Criteria for the rainwater harvesting system must be included in the deed restrictions to be eligible for the stormwater credit.
- (6) *System Maintenance:* The system should be checked annually and after every rainfall to insure the system is operating optimally. The following maintenance should be conducted:
 - Keep debris out of holding areas;
 - Remove collected debris from the first-flush diversion standpipe after each rainfall event;
 - Control and prevent erosion; block and repair erosion trails;
 - Keep debris out of gutters and downspouts;
 - Control and prevent erosion; block and repair erosion trails;
 - Flush debris from storage container bottoms;

- Clean and maintain filters, especially those on drip irrigation systems;
- Expand watering basins as plants grow; and
- Roof washers must be readily accessible for regular maintenance.

4.3.3 Soil Amendment and Conservation Landscaping Credit

Definition of Soil Amendment and Conservation Landscaping Credits

A credit is given when lawns and landscape areas within the development utilize the Soil Amendment or Conservation Landscaping guidance in this section. The benefit of these designs over more traditional lawns is the placement of sufficient soil depth and appropriate vegetation that promotes infiltration and less stormwater runoff.

The Soil Amendment Credit relies on native soils, appropriate soil depths, and low maintenance turf grasses to reduce the runoff volume. **The stormwater credit for Soil Amendment is the reduction of project impervious cover by 2%.**

The Conservation Landscaping Credit is based upon planting a reduced turf area and incorporating native plants, shrubs, trees and perennials to retain stormwater on site and require minimal chemicals to sustain a native and colorful landscape. **The stormwater credit for Conservation Landscaping is the reduction of impervious cover by 5%.**

These credits can be used to gain compliance with the Alternate Standards or reduce the water quality volume.

Soil Amendment Credit

$$A_r = A_D * 0.02$$

Where: A_r = Allowable reduction in impervious cover
 A_D = Area of development

Restrictions on the Credit

The soil amendment credit is subject to the following restrictions:

- Home-builders coordinate with LCRA during soil placement. This coordination will be identified as a permit condition and will allow LCRA to inspect the soil depth and quality prior to grass placement.
- The soil amendment requirement shall be noted on the plat and included in the development deed restrictions.

Example calculation, the required water quality volume before the credit for a ten (10) acre site with 30 single family lots would be:

Impervious cover = 3 acres = 30%

1-year runoff volume = 0.59 inches based on Equation 2.9

Water quality volume = (0.59 inches) * (10 acres) * (43,560/12) = 21,417 cubic- feet.

Applying the credit, the developer and home builders agree to place grass and soil per the soil amendment specifications. Thus, the project impervious cover is reduced by 2%.

In this example, $A_r = (10 \text{ acres}) * (0.02) = 0.2 \text{ acres}$

Effective impervious cover = (3 acres) – (0.2 acres) = 2.8 acres = $2.8/10 = 28\%$

1-year Runoff Volume = 0.56 inches based on Equation 2.9

Water Quality Volume = (0.56 inches) * (10 acres) * (43,560/12) = 20,328 cubic-feet.

The BMP water quality volume is reduced by 5% in this example.

LCRA will make a stormwater credit available to developers and builders who incorporate the soil amendment option into the proposed development. This option is intended to provide builders and homeowners with a well designed, resource efficient landscape.

Description

Naturally occurring (undisturbed) soil and vegetation provide important stormwater functions including: water infiltration; nutrient, sediment, and pollutant adsorption; sediment and pollutant biofiltration; water interflow, storage and transmission; and pollutant decomposition. These functions are largely lost when development strips away native soil and vegetation and replaces it with minimal topsoil and sod. Not only are these important stormwater functions lost, but such landscapes themselves become pollution- generating pervious surfaces due to increased use of pesticides, fertilizers and other landscaping and household/industrial chemicals, the concentration of pet wastes, and pollutants that accompany roadside litter.

Establishing soil quality and depth regains greater stormwater functions in the post development landscape, provides increased treatment of pollutants and sediments that result from development and habitation, and minimizes landscaping chemical need, thus reducing pollution through prevention. Soil amendment and appropriate turf provide a practical and cost-effective mechanism to mitigate stormwater runoff pollution and treatment.

Establishing a minimum soil quality and depth will provide improved on-site management of stormwater flow and water quality. Soil organic matter can be attained through materials such as compost, composted woody material, biosolids, and forest product residuals. It is important that the materials used to meet the soil quality and depth requirements be appropriate and beneficial to the plant cover to be established. Likewise, it is important that imported topsoils improve soil conditions and do not have an excessive percent of clay fines.

Design Guidelines

The soil amendment credit is subject to the following guidelines and restrictions:

- (1) *Stockpile Topsoil:* Salvaged topsoil from the site should be used whenever possible. In any areas requiring grading, remove and stockpile topsoil on site in a designated controlled area to be reapplied to other portions of the site where feasible. Stockpiled soils must be protected from erosion with appropriate temporary erosion controls and cannot be placed adjacent to surface waters, within the buffer zones or in areas with concentrated flow.
- (2) *Soil Depth:* All newly planted turf areas will have a minimum soil depth of 6 to 8 inches. Builders and owners will import soil if needed to achieve sufficient soil depth. Soil in these areas may be either native soil from the site or imported, improved soil.
- (3) *Import Soil:* The topsoil must be weed free, contain a minimum of 20% compost by volume, contain less than 20 percent clay, and be free of stones, stumps, roots or other similar objects larger than one (1) inch. If on-site soils do not meet these specifications, topsoil per the above specs must be added. Sandy loam is not an approved soil and caliche is not considered a soil.
- (4) *Import Soil Application:* Topsoil that is added to the site shall be incorporated in a 2 to 3 inch scarified transition layer to improve drainage. Do not scarify within a drip line of existing trees to be retained.
- (5) *Soil Inspection:* Home-builders should coordinate with LCRA after topsoil has been spread on the site immediately prior to laying sod.
- (6) *Turf:* Is required and shall be Bermuda, buffalo, or zoysia sod.
- (7) *Slope Limitation:* The soil amendment can not be used on slopes greater than 20% or in areas subject to concentrated flows or any sensitive areas to minimize potential discharge of soil to waterways.
- (8) *IPM Guidelines:* Use of this stormwater credit includes compliance with the Conservation and Landscape Guidelines found in Appendix 2.10.4. This guidance provides direction on landscape irrigation systems, chemical application, and deed restrictions.
- (9) *Roadside Revegetation:* Utilizing native seed in revegetation of roadsides and other areas helps preserve ecosystem integrity. Native grasses and wildflowers are well adapted to the environment and provide a low maintenance, resilient long term landscape. A recent study conducted by the Landscape Restoration Program at the Lady Bird Johnson Wildflower Center demonstrated that commercial grass mixes consisting of native plant species seeds performed as

well or better than mixes containing Bermuda grass, a popular and widely used invasive grass species. The table below describes the mix of seed used in the study, and provides the appropriate application rates for the recommended total of 20 pounds of seed per acre.

Roadside Re-vegetation Seed Mix

Common Name	Botanical Name	Application rates
		Lbs/acre
Indiangrass	Sorghastrum nutans	(1.8)
Sideoats grama	Bouteloua curtipendula	(2.0)
Green sprangletop	Leptochloa dubia	(2.6)
Buffalo Grass	Buchloe dactyloides	(1.4)
Little Bluestem	Schizachyrium scoparium	(1.8)
Purple three-awn	Aristida purpurea	(1.4)
Silver bluestem	Bothriochloa laguroides	(6.0)
Canadian wildrye	Elymus canadensis	(1.4)
Engelmann's daisy	Engelmannia pinnatifida	(0.6)
Mexican hat	Ratibida columnifera	(1.0)
Total Grass Seeding Rate		(20.0)

Proper planting and irrigation of native seed is critical to insuring a sound success rate. The planting and watering requirements for native seed may differ from standard mixes. Implementing the seeding guidance provided by the seed supplier will help insure solid establishment. Native seed mixes are also appropriate for caliche soils. Specific caliche seed mixes are available from local suppliers.

Stormwater Credit: A stormwater credit is given when amended soils meeting the criteria listed above are used on all lots within the development. These criteria must be included on the plat and in the single-family development's deed restrictions to receive the stormwater credit. An impervious cover reduction of 2% will be given for projects where amended soils have been applied. Credit is approved in the development permit process and verified with the final grading plan.

Conservation Landscaping

$$A_r = A_D * 0.05$$

Where: A_r = Allowable reduction in impervious cover
 A_D = Area of development

Restrictions on the Credit

The conservation landscaping credit is subject to the following restrictions:

- Home-builders coordinate with LCRA during landscape installation. This coordination will be identified as a permit condition and will allow LCRA to inspect the soil depth and quality prior to grass placement.
- The soil amendment requirement shall be noted on the plat and included in the development deed restrictions.

Example calculation, the required water quality volume before the credit for a ten (10) acre site with 30 single family lots would be:

Impervious cover = 3 acres = 30%

1-year runoff volume = 0.59 inches based on Equation 2.9

Water quality volume = (0.59 inches) * (10 acres) * (43,560/12) = 21,417 cubic- feet.

Applying the credit, the developer and home builders agree to install conservation landscaping per the specifications. Thus, the project impervious cover is reduced by 5%.

In this example, $A_r = (10 \text{ acres}) * (0.05) = 0.5 \text{ acres}$

Effective impervious cover = (3 acres) – (0.5 acres) = 2.5 acres = $2.5/10 = 25\%$

1-year Runoff Volume = 0.50 inches based on Equation 2.9

Water Quality Volume = (0.50 inches) * (10 acres) * (43,560/12) = 18,150 cubic-feet.

The BMP water quality volume is reduced by 14% in this example.

Description

Native vegetation is best suited to local climate and soils. Existing native vegetation should be conserved and protected where possible. Where new planting is required, the use of native plants will increase plant survival and decrease the cost of subsequent plant replacement. Reapplication of organic compost/mulch every few years may be necessary to maintain positive soil infiltration characteristics. The initial costs of native plants, trees, shrubs, and soil amendments are recouped through significant reductions in water, fertilizer and pesticide use, as well as increased plant survival within the first few years after planting.

Conservation landscaping and native vegetation are equally appropriate in large-scale landscapes, such as parks, schools, commercial sites, parking lots and apartment complexes and in small residential landscapes.

The four major components that increase landscape sustainability are: adequate quantity of high quality soil, implementation of efficient irrigation, appropriate turf and plant choice, and installation. Along with obtaining a stormwater credit and protecting water quality, this landscape option will save the homeowner time and money. Below is a front yard sample design comparison between this option and a conventional landscape design for a lot that has a front yard 70 feet wide and 50 feet deep. The conservation option is

composed of shrubs, perennials and ground covers that are watered every 14 days and turf is watered once a week. The conventional lot front yard is comprised mainly of turf and a few shrubs watered three times a week.

Sample Costs Over 10 years (Actual Costs Will Vary)

	<u>Soil Amendment Landscape</u>	<u>Conventional Landscape</u>
Installation Cost	\$3,293	\$2,440
Yard Care Time	425 hours	615 hours
Water Cost	\$360	\$1,440
Treatment Cost	\$50	\$500
Total Time and Cost	\$3,703	\$4,380

As shown above, the conservation option costs \$677 less and requires 190 hours less yard care and maintenance.

Source: LCRA, Texas Hill Country Landscape Option, 2005

The Hill Country Landscape Specification Option developed by LCRA is recommended as a total conservation landscape design package that will comply with the stormwater credit. The designer should contact LCRA at 1-800-776-5272, extension 2230 for additional information and brochures

Design Guidelines

The conservation landscaping credit is subject to the following guidelines and restrictions (see www.lcra.org for more details and photographs of this approach for lots that are 9,500 square feet and 0.5 acres in size).

- (1) *Stockpile Topsoil:* Salvaged topsoil from the site should be used whenever possible. In any areas requiring grading, remove and stockpile topsoil on site in a designated controlled area to be reapplied to other portions of the site where feasible. Stockpiled soils must be protected from erosion with appropriate temporary erosion controls and cannot be placed adjacent to surface waters, within the buffer zones or in areas with concentrated flow.
- (2) *Soil Depth:* All newly planted turf areas will have a minimum soil depth of 6 to 8 inches. Builders and owners will import soil if needed to achieve sufficient soil depth. Soil in these areas may be either native soil from the site or imported, improved soil.

- (3) *Import Soil:* The topsoil for turf areas must be weed free, contain a minimum of 20% compost by volume, contain less than 20 percent clay, and be free of stones, stumps, roots or other similar objects larger than one (1) inch. If on-site soils do not meet these specifications, topsoil per the above specs must be added. Sandy loam is not an approved soil and caliche is not considered a soil.
- (4) *Import Soil Application:* Topsoil that is added to the site shall be incorporated in a 2 to 3 inch scarified transition layer to improve drainage. Do not scarify within a drip line of existing trees to be retained.
- (5) *Soil Inspection:* Home-builders should coordinate with LCRA after topsoil has been spread on the site immediately prior to laying sod.
- (6) *Turf/Native Plants:* Turf shall be Bermuda, buffalo, or zoysia sod. A maximum 30% of the lot can be covered in turf. The remainder of the lot will follow the Hill Country Landscape Option that relies on native trees, shrubs, and perennials (see front pocket and LCRA website for details).
- (7) *Irrigation:* Spray irrigation shall be limited to 2.5 times the foundation footprint with a maximum of 12,000 square feet. The footprint may include the house and the garage but not the driveway or patio.
- (7) *Undisturbed Area Requirement:* For lots greater than 15,000 square feet, no less than 25% of the lot shall remain in a natural condition (no grading, planting sod, etc.). Removal of ashe juniper (cedar) and other invasive species can be performed by hand clearing methods to restore native vegetation and grasses. This area shall not be irrigated. Deed restrictions and plat notes will be necessary to ensure natural area preservation.
- (8) *IPM Guidelines:* Use of this stormwater credit includes compliance with the Conservation and Landscape Guidelines found in Appendix 2.10.4. This guidance provides direction on landscape irrigation systems, chemical application, and deed restrictions.

Stormwater Credit: A stormwater credit is given when conservation landscaping meets the criteria listed above and is used on all lots within the development. These criteria must be included on the plat and in the single-family development's deed restrictions to receive the stormwater credit. An impervious cover reduction of 5% will be given for projects where amended soils have been applied. Credit is approved in the development permit process and verified with the final grading plan.

4.3.4 Disconnection of Rooftop Runoff Credit

Definition of Disconnection of Rooftop Runoff Credit

A credit is given when rooftop runoff is disconnected and then directed to a pervious area where it can either infiltrate into the soil or filter over it. The credit is typically obtained by in areas with slopes less than 5% to promote overland filtering on single family residential lots.

If a rooftop is adequately disconnected, the disconnected impervious area can be deducted from total impervious cover (therefore potentially gaining compliance with the Alternate Standards impervious cover levels or reducing BMP volume). This credit is restricted to single family lots.

Rooftop Disconnection Impervious Cover Credit

Disconnection Length Provided	0 to 14 ft.	15 to 29 ft.	30 to 44 ft.	45 to 59 ft.	61 to 74 ft.	> 75 ft.
% Impervious Cover Credit per By Disconnect (No Storage Volume)	0%	20%	40%	60%	80%	100%
Dry Well, Rainwater Collection, Rain Garden Storage Volume Required to achieve 100% Impervious Cover Credit in Combination with flow length	104 cu-ft.	83 cu-ft.	62 cu-ft.	42 cu-ft.	21 cu-ft.	0 cu-ft.

Source: Maryland Stormwater Design Manual and LCRA.

Where: $A_r = A_{RT} * \%ICD$
 A_r = Allowable reduction in impervious cover
 A_{RT} = Area of roof-top
 $\%ICD$ = Impervious cover credit factor per above Table

Restrictions on the Credit

The rooftop disconnection is restricted to single-family lots and subject to the following restrictions:

- The contributing area of rooftop to a disconnected discharge shall be 800 square feet or less;
- The length of the “disconnection” shall be 75 feet or greater, or compensated using the above table;
- Disconnections will only be credited for lot sizes greater than 5,000 sq. ft;
- **The length of “disconnection” shall be on an average slope of less than 5%;**
- The entire vegetative “disconnection” shall have a minimum soil depth of 4 to 6 inches. Builders and owners will import soil if needed to achieve sufficient soil depth. Soil shall satisfy the import soil specifications found above in Section 4.3.3

(Soil Amendment Credit).

- The disconnection must drain continuously through a vegetated swale or across the vegetated landscape to the roadside curb, conveyance system, or BMP;
- The vegetated landscape should use the appropriate turf grasses identified in Section 4.3.3;
- Downspouts must be at least 10 feet away from the nearest impervious surface to discourage “re-connections”;
- Dry wells, French drains, rainwater collection tanks, or rain gardens (small bioretention areas) may be utilized to compensate for areas with disconnection lengths less than 75 feet. The volume shall be equal to the requirements found in the above table to receive 100% reduction in impervious cover. See Schematic of Dry Well in Figure 4.25 below (additional details can be found in Appendix 2.10.3);
- For those rooftops draining directly to a creek buffer, the rooftop disconnection credit can be used; and
- Credit is documented during the development permit process and verified with the final grading plan as part of the development permit.
- When more than one downspout drains in one direction, the shortest disconnection length will be used in the above table to determine the impervious cover deduction. For example, if the front and back downspout on one side of the house both drain towards the street (flow is combined), the distance from the front downspout to the street will be used as the disconnection length.

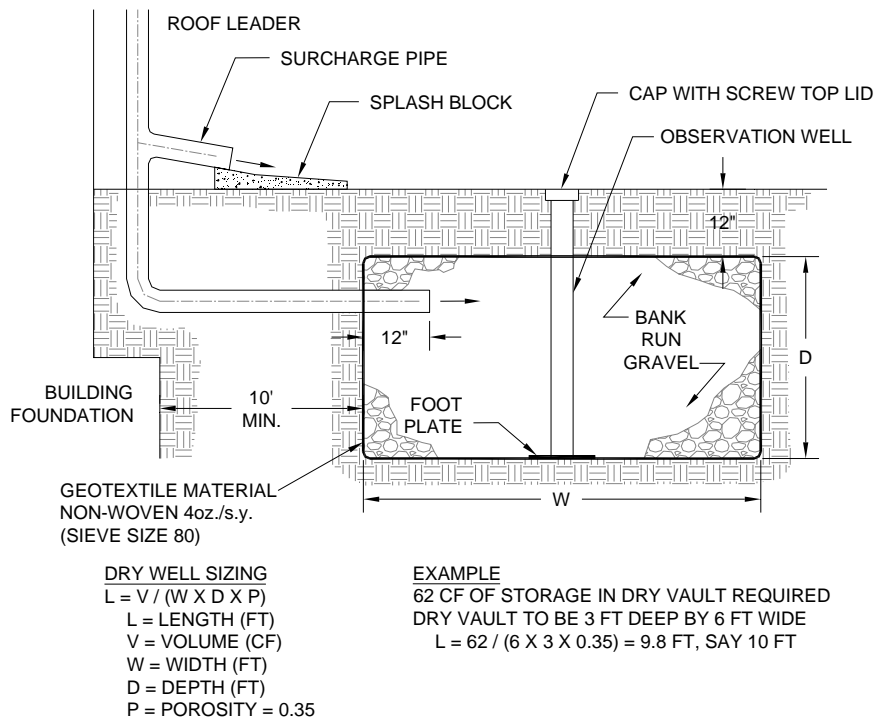

Figure 4.25: Schematic of Dry Well

Example calculation, the required water quality volume before the credit for a ten acre site with 30 single family lots would be:

Impervious cover = 3 acres = 30%

1-year runoff volume = 0.59 inches based on Equation 2-9

Water quality volume = (0.59 inches) * (10 acres) * (43,560/12) = 21,417 cubic- feet.

Applying the credit, each single family lot has a travel length of 35 feet from the house to the roadside curb and the lawns satisfy the vegetative cover requirement by using turf grasses identified in 4.3.10. The designer chooses not to incorporate additional storage (dry wells, rain gardens, etc.) to increase credit. Thus, each house impervious cover is reduced by 40% per Table 2-3.

House roof area = 2000 square feet

40% impervious cover credit for roof from above table

A_r = Allowable impervious cover reduction per house = (2000) * (0.40) = 800 square feet

Impervious cover with credit = (3 acres) – ((30 lots) * (800 sq. ft)) = 2.45 acres

Effective impervious cover = 25%

1-year Runoff Volume = 0.51 inches based on Equation 2-9

Water Quality Volume = (0.51 inches) * (10 acres) * (43,560/12) = 18,513 cubic-feet.

The BMP water quality storage volume is reduced by 14% in this example.

4.3.5 Natural Area Preservation Credit

Definition of Natural Area Preservation

A stormwater credit is given when natural areas are conserved at development sites, thereby retaining pre development hydrologic and water quality characteristics. For Alternate Standards compliance, the preserved area is included in the impervious cover calculations to determine the gross development and cluster development impervious cover levels. The credit for stormwater basin volume is computed by subtracting the preserved area from the area draining to individual water quality basins. This credit is granted for all preservation areas permanently protected under conservation easements or other locally acceptable means. Examples of natural area conservation include:

- Wooded and meadow areas protected from disturbance
- Wetlands and associated buffers
- Other lands in protective easement (floodplains, open space, steep slopes)
- Creek buffers
- Stream systems

Where: $DA_{eff} = DA_{TOT} - A_{NA}$
 DA_{eff} = Effective drainage area
 A_{NA} = Natural area preserved
 DA_{TOT} = Total drainage area

To receive the credit, the proposed preservation area:

- Must not be disturbed during project construction (e.g., cleared or graded) except for temporary impacts associated with selective management of invasive vegetation such as ashe juniper and incidental utility construction or mitigation projects (selective clearing of invasive vegetation shall be performed in a manner to not disturb the soil and shall be approved by LCRA before the action takes place);
- Must be protected by having the limits of disturbance clearly shown on all construction drawings and be delineated in the field except as provided for above;
- Must be located within an acceptable conservation easement or other enforceable instrument that ensures perpetual protection of the proposed area. The easement must clearly specify how the natural area vegetation shall be managed and boundaries will be marked (Note: managed turf (playgrounds, regularly maintain open areas) is not an acceptable form of vegetation management); and
- Must be located on the development project.

Example calculation, the required water quality volume for a ten acre site with three acres of impervious area and three acres of protected conservation area before the credit would be:

Impervious cover = 30%

1-year runoff volume = 0.59 inches based on Equation 2-9

Water quality volume = (0.59 inches) * (10 acres) * (43,560/12) = 21,417 cubic- feet.

Applying the credit, three acres of conservation area is subtracted from total site area, which yields a smaller water quality basin volume. The impervious cover amount is not revised to reflect the smaller drainage area:

$DA_{\text{eff}} = (10 \text{ acres}) - (3 \text{ acres}) = 7 \text{ acres}$

Effective impervious cover = 30%

1-year runoff volume = 0.59 inches based on Equation 2-9

Water Quality Volume = (0.59 inches) * (7 acres) * (43,560/12) = 14,992 cubic-feet.

The BMP water quality storage volume is reduced by 30% in this example.

4.3.6 Wet Vault Credit

Description of Wet Vault Credit

Pretreatment using a wet vault under the performance standards of the LCRA Highland Lakes Watershed Ordinance will eliminate the need to oversize water quality basin BMPs for lost storage due to sedimentation deposition. For example, a wet vault placed before an extended detention pond will eliminate the requirement to oversize the basin by 5% as required in Chapter 4.2.3.

A wet vault is a vault with a permanent water pool, generally 3 to 10 feet deep. The vault may also have a constricted outlet that causes a temporary rise of the water level (i.e., extended detention) during each storm; however, most of these devices treat stormwater runoff as flow-through type devices. These devices are normally marketed as proprietary devices and sold as Stormceptor, Baysaver, CDS, Vortechincs and many other similar systems.

To receive the credit a wet vault must meet the following requirements:

- The device must be able to accept without bypass the runoff from the 1-yr, 3-hr peak flow rate from the contributing drainage area; and
- Wet vaults are normally proprietary systems designed by the various manufacturers. This guidance document has no specific suggestions on the internal configuration of these units. Manufactures specifications should be followed.

When considering these devices for implementation, it should be noted that a broad, shallow device with a large surface area will achieve greater TSS removal than a facility with the same volume, but which is deeper. It is recommended, but not required, that the device has an internal configuration that will promote uniform flow through the device and have baffles or other geometric features to trap litter and other floating material.

4.3.7 Dealing with Multiple Credits (Conservation Development Design)

Site designers are encouraged to perform a development design that works with the natural topography, soils, and vegetation to utilize as many credits as possible. Greater reductions in stormwater storage volumes can be achieved when credits are combined (e.g., disconnecting rooftops and protecting natural conservation areas). The use of multiple credits can gain compliance with the Alternate Standards or significantly reduce water quality basin size and cost.

Example - Combined Use of Multiple Stormwater Credits to Achieve Alternate Standards Compliance

Development area = 10 acres

40 single-family lots

Lot sizes average 9,500 square feet (70 feet by 135 feet)

Lot impervious cover = 2,500 square feet/lot per Table 2-4

Use roadside swales, not curb and gutter to gain Alternate Standards Compliance

Proposed impervious cover = 3.4 acres = 34%

Maximum allowed impervious cover for Alternate Standards = 15%

Need to use Stormwater Credits to achieve 15% impervious cover limit

Use **porous pavement credit** for driveways; receive 90% I.C. credit for porous pavement area

Driveway Area = 800 square feet (50 feet long by 16 feet wide)

$A_r = \text{Allowable impervious cover reduction} = (40 \text{ lots}) * (800 \text{ sq ft}) * (0.90) = 0.66 \text{ acres}$

Use **roof-top disconnection credit** for lots with slopes less than 5%

Flow length from home to street = 50 feet, however only 30 lots meet 5% slope limitation
Designer chooses not to include rainwater gardens, dry wells, etc to gain additional credit
Impervious cover reduction = 60% per Table 2-3
Roof Area = 2500 – 800 (driveway area) = 1,700 square feet
 $A_r = \text{Allow. Imp. Cover Reduction.} = (30 \text{ lots}) * (1,700 \text{ sq ft}) * (0.60) / 43,560 = 0.70 \text{ ac}$
 $IC_{\text{eff}} = (IC_{\text{TOT}}) - (\text{Sum of } A_r) = (3.4 \text{ acres}) - (0.70 + 0.66) = 2.0 \text{ acres}$
 $IC_{\text{eff}} = \text{Effective Impervious Cover} = 2.0 / 10 = 20 \%$

Not able to meet 15% impervious cover level for Alternate Standards

Select another stormwater credit. The designer could select rainwater collection or add a rain garden to the roof-top disconnection to achieve required impervious cover reduction. Another option is the use of the Conservation Landscaping credit.

Designer selects **conservation landscaping credit**

Reduce total project impervious cover by 5%

Project Effective Impervious Cover = 20% - 5% = 15%

Effective Impervious Cover equals 15%, project in compliance with Alternate Standards

No water quality design for permanent BMPs is necessary. Proceed to preparation of erosion and sedimentation control plan. Coordinate with LCRA to develop appropriate water quality education program for residents.

4.4 Stormwater Management for Individual Lots

In an effort to reduce effective impervious cover on a lot by lot basis, the following approach can be used to employ various stormwater credit options to achieve this goal. The designer will input sizes and options of stormwater credits to manage the impervious cover on the lot. The designer can use any combination of BMPs to achieve the targeted amount. A spreadsheet is found on the CD in the front pocket of this manual and illustrated in Table 4-1 below. Please refer to Appendix 2-10 for details on the design and construction of on-lot BMPs.

Table 4-1 - STORMWATER CREDITS FOR RESIDENTIAL LOTS

This worksheet is used to determine the credits necessary to meet impervious cover limits for compliance with LCRA Highland Lakes Watershed Management Ordinance

Input the following data:

1	lot impervious cover limit			sf
	proposed impervious cover			
2		home		sf
3		garage		sf
4		driveways		sf
5		sidewalks		sf
6		total		sf
7	excess impervious cover			sf

determine potential measures to mitigate excess impervious cover:

Calculated (required sizes are for one of the following options - a combination of options may also be used)

8	porous pavement area	=line # 7 / 0.9		sf
9	rainwater harvesting, % area IC reduction necessary	= (line #7 / line #6)		%
10	Rain barrel volume/catchment area	From Figure 2-1		ft
11	Catchment area	= line #6		sf
12	Rainwater harvesting volume, barrel volume	= line #19 X line #20 X 7.48		gal
13	raingarden area, 6" depth	=(line # 7 X 104) /(800 X 0.50)		sf
14	raingarden area, 8" depth	=(line # 7 X 104) /(800 X 0.67)		sf
15	raingarden area, 10" depth	=(line # 7 X 104) /(800 X 0.83)		sf

Proposed (select a combination of options to obtain a total credit equal or greater than the excess IC in line 19)

16	porous pavement area	cannot exceed total of lines 4&5		sf
17	" credit	=line #7 X 0.9		sf
18	dry well volume provided			cf
19	" credit	=(line #7 X 800 X 0.35)/104		sf
20	rainwater harvesting, % area IC reduction necessary	= (line #7 / line #6)		%
21	Rain barrel volume/catchment area	From Figure 2-1		ft
22	Catchment area	= line #6		sf
23	Rainwater harvesting volume, barrel volume	= line #19 X line #20 X 7.48		gal
24	raingarden area, 6" depth			sf
25	" credit	=(line #7 X 800 X 0.50)/104		sf
26	raingarden area, 8" depth			sf
27	" credit	=(line #7 X 800 X 0.67)/104		sf
28	raingarden area, 10" depth			sf
29	" credit	=(line #7 X 800 X 0.83)/104		sf
30	total credit (must be greater or equal to excess impervious cover)			

4.5 *Stormwater Management for Ridgeline/Isolated Lots*

Due to topography found in the ordinance jurisdiction, lots can be located down-gradient of the road and drain to an undeveloped canyon or creek buffer zone below. When a development permit is issued under alternate standards, stormwater management design for ridgeline/isolated lots is not necessary since the goals of low impervious cover and hydrologic design were met. When developments can not achieve the alternate standards criteria, this row of lots that drain to ridgelines, canyons, buffer zones, and natural areas can gain water quality compliance through the use of the options below. Use of the following options provides water quality management and avoids structural water quality practices and attempting to convey runoff from a row of lots to a BMP. LCRA's approval of the following options is based on lot grade, soils, proximity to waterway, and existing vegetation, i.e., all options may not be available for each development. In addition, the proposed option must be identified at the pre-development planning meeting and the erosion and sedimentation control plan shall provide guidance to manage the approved plan including financial security during the construction phase.

Options

- (1) Design the water quality basin to include the drainage area of the row of lots that does not drain to the basin. For example, the development drainage area to the basin is 15 acres based on curb, gutter, and the storm drain system. The row of lots has a drainage area of 0.8 acres that drains across the back of lot to the natural area below. Therefore, the water quality basin is sized for a 15.8 acre drainage basin and includes the impervious cover within the row of lots. In addition to increasing the basin size, this option also requires the row lots to use soils and turf per the specs identified in the soil amendment credit or lot landscapes per the conservation landscaping credit found in Section 4.3.3 above. Finally, the Conservation and Landscape Guidelines found in Appendix 2.10.4 must be incorporated in the deed restrictions to limit chemical use and water quality impact.
- (2) A vegetated filter strip can be located down-gradient and off of the lot in an easement. The filter strip must satisfy the vegetation design guidelines found in Section 4.2.7. Minimum filter strip widths are:
 - Natural Filter Strip, 30 feet
 - Engineered Filter Strip, 20 feet
 - Engineered Vegetative Infiltration Strip, 15 feet
- (3) Bioretention through the use of rock stack walls and soils per the bioretention specs found in Section 4.2.2. This "back lot" bioretention system does not require an underdrain system but does require a dry stack rock wall height of 2.5 feet that is backfilled with soil to a depth of two feet. Non-woven 4 ounce filter fabric is placed between the rock wall and soil to prevent fines from migrating through the rock openings. Runoff from the lot will sheet flow into the bioretention area and then

infiltrate through the soil. The top of rock must be at least six inches above the bioretention soil media which is flat in elevation. The bioretention bed shall run perpendicular to the flow path and extend across the full lot width.

- (4) In most storm events, runoff will not discharge from the lawn itself. When the roof area and driveways contribute runoff, then the runoff can exceed the infiltration rate of the soil and lead to discharge from the property. This option allows a builder to pipe the roof top runoff to a dry well or set of drywells located at the back property line. The drywells are designed per the guidance found in Section 4.3.4 and per the detail in Appendix 2.10.3. This option also requires the row lots to use soils and turf per the specs identified in the soil amendment credit or lot landscapes per the conservation landscaping credit found in Section 4.3.3 above. Finally, the Conservation and Landscape Guidelines found in Appendix 2.10.4 must be incorporated in the deed restrictions to limit chemical use and water quality impact.

Chapter 5

Permanent BMP Maintenance Guidelines

5.1 Maintenance Plan

A maintenance plan developed by the design engineer and acceptable to the LCRA will be required prior to approval of the development permit. The following information should be included in the proposed maintenance plan. This plan will serve as the basis for the development of the BMP Maintenance Permit once the project is constructed.

Specification of routine and non-routine maintenance activities to be performed;

- (1) A schedule for maintenance activities,
- (2) Provision for access to the tract by LCRA or other designated inspectors,
- (3) Name, qualifications and contact information for the party(ies) responsible for maintaining the BMP(s),
- (4) The plan should be signed and dated by the party responsible for maintenance,
- (5) Signs to be posted by developer, and
- (6) For basin-type BMPs, provide location and description of sediment depth markers; identify sediment depth that will necessitate sediment removal operations.

5.2 General Guidelines

The ability and the commitment to maintain stormwater BMPs are necessary for the proper operation of these facilities. Maintenance requirements should be considered whenever a stormwater management practice is planned, designed, or reviewed. BMPs should be selected and designed in order to minimize the frequency and complexity of the maintenance operations.

Maintainability and facility access are particularly important issues if a proposed BMP will be installed below grade and covered. This type of configuration is becoming more common in space constrained areas and the maintenance plan should specify how these issues are addressed. In addition, these facilities may be considered as “confined space” requiring special equipment to enter and maintain according to OSHA and other regulatory agencies.

Accessibility

According to many maintenance personnel, the biggest problem they encounter is not the amount or frequency of maintenance they must perform, but the difficulties

they have in simply reaching the location of the required maintenance work. In order for proper maintenance to be performed, the various components of the stormwater system and, indeed, the facility itself, must be accessible to both maintenance personnel and their equipment and materials. Physical barriers such as fences, curbs, steep slopes, and lack of adequate and stable walking, standing, climbing, and staging areas can seriously hinder maintenance efforts and drastically increase maintenance difficulty, cost, time, and safety hazards. Amenities such as depressed curbs, hand and safety rails, gates, access roads, hatches, and manholes will expedite both inspection and maintenance efforts and help hold down costs and improve efficiency.

Important design considerations for components such as gates, hatches, manholes, trash racks, and other components that must be lifted or moved during inspection or maintenance operations, include both the item's weight and a secure place to put it when it's not in its normal location. When weight becomes excessive, mechanical aids such as hoists, lifts, and lifting hooks should be provided. When fastening removable items like trash racks, orifice and weir plates, and gratings, the use of non-corroding, removable, and readily accessible fasteners will also help greatly.

Sometimes design considerations may conflict. For example, in designing access roads, they must have the proper turning radius, slope, and wheel loading to allow cleaning of a pond by heavy construction equipment. The road's storm drain covers, designed for the desired wheel loading, may be too heavy to move easily. Perhaps a different access way may need to be provided.

Finally, legal barriers such as lack of access rights or inadequate maintenance easements can stop the best maintenance efforts before they can even get started. This is especially pertinent to project reviewers, who normally have the authority to require such legal aspects of the project.

Durability

The use of strong, durable, and non-corroding materials, components, and fasteners can greatly expedite facility maintenance efforts. These include strong, lightweight metals such as aluminum for trash racks, orifice and weir plates, and access hatches; reinforced concrete for outlet structures and inlet headwalls; hardy, disease resistant vegetation for bottoms, side slopes, and perimeters; and durable rock for gabions and riprap linings. In most instances, the extra investment normally required for more durable materials will pay off over time.

5.3 Basin Dewatering

A common sign of failure of some permanent BMPs is standing water long after the rain event ends. This is especially true in sand filters, dry extended detention basins, and retention basins. In addition, wet ponds may also need to be drained for maintenance purposes. The water in each of these systems can be pumped into the stormwater

conveyance system downstream of the BMP as long as it has been at least 24 hours since the last rain event. This delay provides sufficient time for most of the pollutants to settle out of the standing water. Even more appropriate is to discharge basin water onto a vegetated area that is capable of providing filtering and infiltration. The discharge should be conducted in a sheet flow manner to prevent erosion of the vegetated area.

5.4 *Sediment Disposal*

Stormwater pollutants include a variety of substances that are deposited on pervious and impervious surfaces and then transported by the next rainfall. In addition, there may be connections to the stormwater system that should go to the sanitary sewer system in older urbanized areas. Consequently, a variety of contaminants that may be classified as hazardous or toxic may enter stormwater management systems. These contaminants include heavy metals, petroleum hydrocarbons, pesticides, and a variety of organic chemicals. Consequently, several federal and state laws and regulations may apply to the disposal of sediments which accumulate in stormwater systems or which are captured by street sweepers.

Maintenance of BMPs frequently requires disposal of accumulated sediment and other material. These materials are normally classified as special wastes when disposed of in municipal landfills.

A Type 1 Municipal Solid Waste (MSW) landfill can accept household waste--anything else is a special waste as defined in 30 TAC 330.2 (137). Special waste is a waste that requires special handling at a Type I MSW landfill. Labeling a filter media or sediment as a special waste is not a waste characterization.

The process to obtain authorization to dispose of a special waste begins with a request for approval called the "Request for Authorization for Disposal of Special Waste TCEQ Form 0152." The request is completed by the generator and submitted to the MSW permits section of the TCEQ for Executive Director review/approval. The MSW permits section performs the review described in 30 TAC 330.136 (reviews the request and either approves, disapproves, or requires additional information).

5.5 *BMP Maintenance Requirements*

5.5.1 Detailed Inspections and General Maintenance

Detailed BMP inspections should occur at least twice annually. At least one of these inspections should be during or immediately following a runoff producing event. Detailed inspections should be performed by an engineer or other stormwater treatment professional. Any deficiencies identified during an inspection should be repaired immediately. The remainder of this section should be treated as a minimum checklist of items that needs to be covered during an inspection.

Maintenance operations may be required as a result of deficiencies identified during a site inspection. However, general site maintenance, as described in the Section 5.5.2, should be performed on a regular basis, regardless of the timing of more detailed inspections. Site maintenance should be performed as required to maintain site aesthetics, vegetation, BMP access, and debris removal. At a minimum, site maintenance should be performed twice annually.

5.5.2 General Site Maintenance

- (1) Identify, replant, and restore eroded areas. Add a level spreader, energy dissipation, or other repairs as required to ensure that erosion is not repeated.
- (2) Identify areas that do not have acceptable vegetated covers (80% or higher for most BMPs). Reseed, add soil, and irrigate as required to ensure that coverage requirements are met.
- (3) Mow sites twice annually and as required to keep grass height under 18 inches. Additional mowing may be performed for site aesthetics. Export clippings from site to prevent release of nutrients from decaying plant matter. Remove any woody growth, especially from embankments, berms, and swales. For swales, grass should not be regularly mowed below four inches.
- (4) Use non-chemical methods for maintaining health of vegetation. Pesticides, herbicides, or fertilizers should only be used as a last option, and then as minimally as possible. Fertilizer should rarely be required because runoff will typically contain sufficient nutrient loads.
- (5) Irrigation may be required in order to maintain acceptable levels of vegetated coverage, especially for engineered vegetated strips.
- (6) Never deposit grass clippings, brush, or other debris in BMPs or buffers.
- (7) Prevent over-compaction of BMP components that rely partially or wholly on infiltration (vegetation strips, bioretention bed, infiltration trenches and basins). Mowing and other maintenance should be performed with hand equipment or a light-weight lawn tractor.
- (8) Remove any built-up sediment and debris, especially along uphill edges, berms, swales, and level spreaders; and around BMP inlets and outlets.
- (9) Identify any other problems. A detailed inspection may be required.

5.5.3 Inspection and Maintenance of Water Quality Basin BMPs:

Requirements for ALL water quality basins:

- (1) Have sediment removed from forebays and water quality basins whenever it reaches 10% of volume (typically 3-6 inches), or if it impedes flow through the BMP resulting in standing water or decreased performance, or if there are signs of sediment erosion and re-suspension. At a minimum, remove sediment from the sediment forebay every 7-10 years, and from the primary basin every 15 years.
- (2) Have sediment removed from top of bioretention beds, sand filters, infiltration trenches, and infiltration basins whenever and wherever it exceeds 1" in depth, or whenever design drawdown time is exceeded.
- (3) Remove sediment from inlet and outlet works of BMPs whenever it reaches 3" or impacts performance.
- (4) Remove sediment from under-drains as required to ensure that they do not restrict flow through BMP. If condition of under-drains cannot be visually verified, they should be cleaned at least every 5 years
- (5) Maintain access roads, so that vehicles and equipment can reach all BMPs. Ensure that entire outer perimeter of BMP is kept clear and accessible.
- (6) Remove debris and litter from BMP site, especially at inlet and outlet works.
- (7) Identify and repair any structural damage including repairing cracked concrete, sealing voids, and removal of vegetation from cracks and joints.
- (8) Identify and repair any subsidence, leakage, and cracking along pond embankments.
- (9) Evaluate for nuisances (insects, weeds, odors, algae, etc.) particularly in areas of permanent standing water. If standing water is not part of BMP design, then BMP should be repaired to improve drainage. If standing water is required (i.e. wet pond, wetland) or desirable for aesthetics, then use non-chemical solutions whenever possible to remove nuisances. Fish such as flathead minnow are recommended for control of algae and mosquitoes.
- (10) Treat or replace any diseased vegetation. Replace any dead vegetation. For wet ponds and wetlands, multiple plantings may be required before a viable mix of plant-life is found.

BMP-Specific Requirements:

- (1) Sand Filters: Replace top layer of sand filter as required to ensure that design drawdown time is not exceeded.
- (2) Bioretention: Add mulch where required to maintain 2"-3" thick layer at locations where ground vegetation is not present. Mulch layer should be replaced every 2-3 years. If bioretention incorporates sand filter overflows, then maintain per sand filter criteria.
- (3) Retention/Irrigation: Inspect and test operation six times annually, at least twice immediately following wet weather. Immediately repair any leaks, broken spray heads, or other malfunctions. Remove sediment from sump when it reaches 3 inches or impacts pump performance. Trim vegetation so that it does not interfere with irrigation equipment.
- (4) Infiltration Trench: Assess drawdown time using observation well. Scarify or remove and replace top filter layer of trench, as required to ensure design drawdown times. If complete rehabilitation is necessary, remove all stone and remove sediment deposited in base of trench. Till bottom of trench and wash and replace stone.
- (5) Infiltration Basin: Scarify infiltration surface with a hand-guided rotary tiller or light-weight lawn tractor with tiller, as required to ensure design drawdown times.
- (6) Porous Concrete: Follow all of manufacturer's maintenance recommendations. Maintain signs preventing the placement of dirt and chemicals on pavement surface. Inspect for adequate permeability during heavy rainfall at least twice per year (ponding water or runoff from pavement surface are indications that system is not functioning adequately). If performance decreases below design levels, and pressure or vacuum washing does not prove effective, then pavement replacement or additional BMPs will be required.
- (7) Wet Basins: If basin is designed with a permanent pool, ensure that water levels are sufficient to maintain aquatic habitat during dry months. Provide supplemental water if required.

5.6 BMP Maintenance Permit

Once a project containing permanent BMPs is completed, the project owner must complete a BMP Maintenance Permit Application per Appendix 1.7.1 following the submittal requirements in Appendix 1.7. Also, the party responsible for BMP maintenance should use the checklists found in Appendix 1.7.2 and 1.7.3 to guide their inspections and maintenance activities.

Chapter 6 – Development Activity

Dredge and Fill Standards on the Highland Lakes

6.1 Preface

The Lower Colorado River Authority (LCRA) no longer requires that property owners obtain an LCRA permit for dredge and fill projects. However, LCRA has the authority to enforce these standards, and will evaluate violations of the standards on a case-by-case basis. **Property owners are still required to comply with requirements of Section 404 of the Clean Water Act and notify the U.S. Army Corps of Engineers (USACE) prior to beginning a project.**

LCRA developed these Dredge and Fill Standards as a companion to the USACE requirements. LCRA designed the standards to help shoreline property owners and contractors avoid problems and situations associated with dredge and fill practices in the Highland Lakes.

By complying with the USACE requirements and LCRA's Dredge and Fill Standards, shoreline owners can help protect their property from erosion, maintain navigability and ensure the protection of the Highland Lakes.

LCRA does not assess fees as part of implementing these standards.

The summary below highlights key components found in the Dredge and Fill Standards.

- All fill and shoreline stabilization work must follow the existing shoreline, unless otherwise authorized by LCRA. Reclamation of lost property due to erosion is not allowed.
- LCRA does not allow encroachments or unauthorized fill on LCRA property. Approval from LCRA is required before dredging on LCRA land.
- All dredged material needs to be removed from lakebed and placed above listed lake elevations.
- Contact LCRA to obtain work checklist if the length of shoreline work exceeds 500 feet or if the volume of dredged material exceeds 500 cubic yards (see example calculation Figure 6-4).
- Shoreline activity above listed lake elevations listed may require a development permit.

For additional copies of these standards, or to address questions or concerns, please contact LCRA Water Resource Protection at 1-800-776-5272, Ext. 2324.

For information on U.S. Army Corps of Engineers (USACE) requirements, please see contact information listed below.

U.S. Army Corps of Engineers, Ft. Worth District

P.O. Box 17300, Ft. Worth, Texas 76102

Phone: 1-817-886-1731

www.swf.usace.army.mil (click on "Permits")

6.2 Definitions

Words used in these standards but not defined in this section will have their ordinarily accepted meaning. For the purpose of these standards, the following words and phrases are defined.

Contractor: Any person, other than the owner, engaging in land development and construction activities.

Dredge: The removal or disturbance of material from below the stated normal conservation pool elevations of the lakes.

Erosion: The detachment and movement of soil, sediment or rock fragments by wind, water, ice or gravity.

Erosion Control: Devices such as silt fence, rock berm and soil protection blankets that prevent soil migration from the site. See LCRA's Erosion Control Guide for more information, available by calling 1-800-776-5272, Ext. 2324.

Fill: Any material, structure, wall, riprap or revetment below the stated normal conservation pool elevations of the lakes.

Highland Lakes: Include Lake Buchanan, Inks Lake, Lake LBJ, Lake Marble Falls and Lake Travis on the Colorado River within the LCRA district.

Lakewide Permit: A permit issued by LCRA that allows for expedited permitting of certain activities under certain conditions when work is performed on Highland Lakes property during lake drawdowns. Because lakewide permits are reissued from time to time, the actual permit number may change.

Shoreline: The line at which the water surface of each Highland Lake intersects the land at any given time. The shoreline will move as the surface elevation of a lake changes.

6.3 Dredge and Fill Activities

Dredge and fill activities are most common among property owners constructing stabilization projects on a single-family waterfront lot. Although construction of retaining walls and removal of sediment from the lakebed are the most typical activities that fall under LCRA's Dredge and Fill Standards, the standards also address:

- Bulkhead, rock riprap or revetment construction and repair that include backfilling behind the wall and installing toe protection or tiebacks. Retaining walls must follow the existing shoreline.
- Use of a bulldozer, front-end loader or backhoe to move sediment from areas normally below the lake elevation listed in this booklet to an area above the lake elevation listed in this booklet.
- Construction or maintenance of shoreline protection systems.
- Construction or maintenance of recessed boat slips.
- Construction or maintenance of boat ramps.
- Contact LCRA to obtain checklist, if the length of shoreline work exceeds 500 feet or the volume of dredged material exceeds 500 cubic yards (see example calculation Figure F-4).
- Contact LCRA prior to all dredging activities on LCRA property.

6.4 Other Regulations

Compliance with the Dredge and Fill Standards on the Highland Lakes does not ensure compliance with requirements or regulations from other entities. Entities with jurisdiction may include cities, counties, property owners associations and homeowners associations. Compliance may be required with other sections of LCRA's Highland Lakes Watershed Ordinance, LCRA's Safety Standards for residential docks, land and water use regulations and on-site sewage facilities program. In cases where LCRA and another entity have different regulations or requirements, the most stringent regulations apply.

6.5 Highland Lakes Elevation Levels

LCRA's Dredge and Fill Standards apply to work below the following stated lake elevations on the Highland Lakes:

Lakes Travis (681' mean sea level)

Lake Marble Falls (738' mean sea level)

Lake LBJ (825' mean sea level)

Inks Lake (888' mean sea level)

Lake Buchanan (1,020' mean sea level)

6.6 Property Ownership

The water surface is public domain. LCRA is responsible for protecting water quality, enforcing safety and regulating use of the Highland Lakes. The right to do work along the shoreline or dredge in the lakebed depends on who owns the land where the work will take place.

6.6.1 Privately Owned Land

LCRA requires that the property owner, who will be performing the dredge and fill activities, own the land where all such activities will take place.

It is the property owner's responsibility to determine land ownership and the boundaries of that ownership. Information on the boundaries of ownership can be obtained from a variety of sources, such as county deed records, title companies and appraisal districts.

If there is a dispute over the placement of fill or construction of shoreline stabilization structures over land not controlled by the property owner doing the work, the dispute must be settled in a court of competent jurisdiction. LCRA has no jurisdiction regarding the litigation of these matters.

6.6.2 Publicly Owned Land

Some land under the Highland Lakes could be owned by a city or county, the state or another public entity such as LCRA. Each of these entities may have its own requirements for dredge and fill activities over land they own.

Property owners must determine which public entity owns the land and what type of permission is needed before conducting work. Property owners are responsible for complying with any requirements imposed by an entity that has jurisdiction over the property. You may determine ownership through the county courthouse or tax appraisal offices. When researching ownership, use the most recent existing survey or plat.

If you are located on Lake Travis or Lake Buchanan, you will need to take particular notice of ownership below the lake elevations as listed in this booklet and avoid encroaching on

LCRA property.

LCRA does not allow encroachment on LCRA land; all activities must be conducted on the property owner's land. Dredging on LCRA property requires approval from LCRA before beginning work. Any unauthorized fill placed on LCRA land will be subject to removal at land owner's expense. For help determining LCRA ownership of shoreline land, please contact LCRA's Real Estate Services at 1-800-776-5272, Ext. 7986.

6.7 Land Reclamation — Not Allowed

Property owners are not permitted to reclaim lost property resulting from the natural erosion process or a flood event. All shoreline stabilization projects and fill work must be conducted on or above the lake elevations listed in this booklet.

6.8 Water Quality Protection

Dredging material from a lakebed, installing retaining walls or other bank stabilization structures, and conducting other site disturbances can temporarily impact Highland Lakes water quality. Such projects may require removing a substantial amount of material. To reduce erosion and sediment in the lakes or tributaries during construction projects or other land-disturbing activities, take the following steps:

- Place dredged material above the lake elevations listed in this booklet in a manner that will prevent material from re-entering the lake through runoff.
- Perform work in a manner that prevents runoff of fill material, dredged material and pollutants into the waters of the Highland Lakes. Minimize removal of natural vegetation, revegetate the disturbed area as soon as possible, and provide temporary erosion and sedimentation controls during the project. For more information on the use of erosion and sedimentation controls contact LCRA Water Resource Protection at 1-800-776-5272, Ext. 2324.
- Dredging in submerged conditions may require special techniques such as coffer dams or turbidity curtains. Contact LCRA for more information. Dredging should be performed in dry conditions during a scheduled lake lowering or other low water level conditions.
- Keep erosion controls in place and maintain them until vegetation in the fill area is at least 70 percent established.
- Gradually slope dredged areas to blend the newly dredged area into the existing channel bottom contour. Smooth dredged areas to prevent any irregular surfaces or cuts that might collapse (see Figure F-5).
- Limit fill material to native soils obtained at the work site, concrete, sand, gravel, rock

or other coarse aggregate material. Fill material must be free of waste, scrap metal products, organic materials and unsightly debris.

- Dredging in a cove that is fed by a creek may increase erosion, especially on flood control lakes. Contact LCRA to discuss if this condition is present.

6.9 Ensuring Navigability of Waters

All work must not interfere with others' reasonable access to, or use of, navigable waters. Retaining walls must be designed and built to adequately control erosion and not present a hazard to navigation.

To ensure navigability, the fill for the retaining wall must follow the existing shoreline and be limited to the minimum required to stabilize the shoreline. The wall must not exceed the length of the property owner's waterfront property line.

6.10 Shoreline Protection Techniques

Managing the effects of wave heights and run up should be incorporated into the design of shoreline protection. The design should minimize the effects when shoreline protection fails and overtopping occurs. For guidance on shoreline protection parameters, see Tables 6-1 and 6-2 on page 6-7.

Table 6.1 Riprap Size for Wave Protection

Table 1: Riprap Size for Wave Protection

(Source: HEC-11 Chart 7. Hudson Relationship for Riprap Size Required to Resist Wave Erosion)

$$D_{50} = 0.57H / \cot 1/3 q$$

D₅₀ = Median Riprap Size (in) H = Wave Height (ft)
 q = Bank Angle with Horizontal

		bank side slope (horizontal:vertical)					
D ₅₀ , in		2:1	2.5:1	3:1	4:1	5:1	6:1
H, ft							
1		5	5	5	4	4	4
2		11	10	9	9	8	8
3		16	15	14	13	12	11
4		22	20	19	17	16	15
5		27	25	24	22	20	19
6		33	30	28	26	24	23

example: H = 3 feet, side slope = 2 horizontal to 1 vertical
 result - use rock with D₅₀ of 16 inches

Table 2: Wave Run-Up Height for Angular Rock Riprap

(Source: HEC-11 Chart 8. Wave Run-up on Smooth, Impermeable Slopes and Table 9. Correction for Wave Run-up)

$$R = \text{Wave Run-up Height (ft)}$$

$$H = \text{Wave Height (ft)}$$

$$q = \text{Bank Angle with Horizontal}$$

$$F = \text{Correction Factor (0.6 for angular rock riprap)}$$

		bank side slope (horizontal:vertical)					
R, ft		2:1	2.5:1	3:1	4:1	5:1	6:1
H, ft							
1		1.7	1.9	2.0	2.2	2.2	2.2
2		3.4	3.7	4.0	4.3	4.3	4.3
3		5.0	5.6	5.9	6.5	6.5	6.5
4		6.7	7.4	7.9	8.6	8.6	8.6
5		8.4	9.3	9.9	10.8	10.8	10.8
6		10.1	11.2	11.9	13.0	13.0	13.0

example: H = 3 feet, side slope = 2 horizontal to 1 vertical
 result - wave run-up extends 5 feet above water level

Table 6-2 Wave Run-Up Height for Angular Rock Riprap

Research has shown that a ski boat traveling at 20 miles per hour (mph), 100 feet from shore can generate a 3-foot wave. Likewise, a 50 mph wind across a lake from shore to shore measuring a distance of 10,000 feet generates a 3-foot wave. These are typical examples of wave height that could overtop your shoreline protection (see Figures 6-1 and 6-2).

6.10.1 Use of retaining walls and riprap to stabilize eroded shorelines

- Walls and riprap must be placed along the existing shoreline. Reclamation of land is not allowed.
- Walls may match existing retaining walls to minimize debris collection and maintain a consistent shoreline. However, walls should be angled back to match the existing shoreline to avoid reclamation.
- Construct the wall using stone, concrete blocks, poured concrete, rock, gabions (rock wrapped with wire mesh that is commercially manufactured for erosion control) or other coarse aggregate material.
- Place rock riprap at the base of the retaining wall (see Figure 2) to protect the wall from being undermined, which can lead to wall collapse, and to ensure maintenance of aquatic habitat.
- Use riprap material that is natural or quarry-run stone.
- Do not use concrete rubble or other debris salvaged from construction sites to stabilize shorelines.
- Limit site preparation to the work necessary to obtain adequate slope and stability of the riprap material.
- Perform site preparation to follow the existing contour of the land.

For examples of inadequately designed shoreline protection systems, see Figure 3.

The three pictures show erosion behind the structure (scouring), slumping that results from the scouring, and flank erosion.

Figure 6-1 Slope Protection Using Rock Riprap

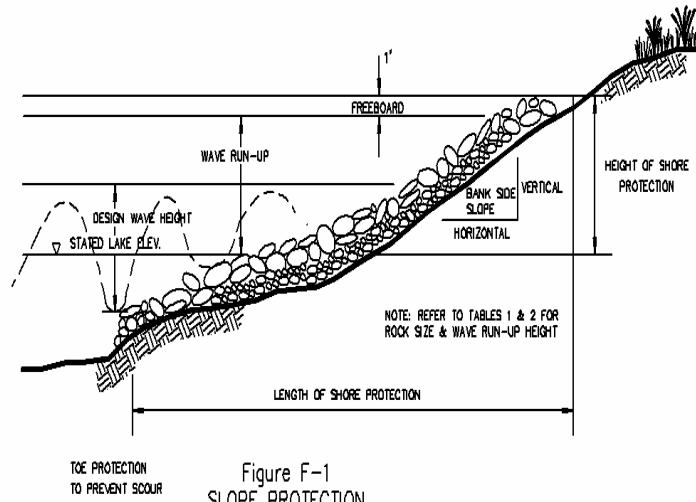

Figure F-1
SLOPE PROTECTION
USING ROCK RIPRAP

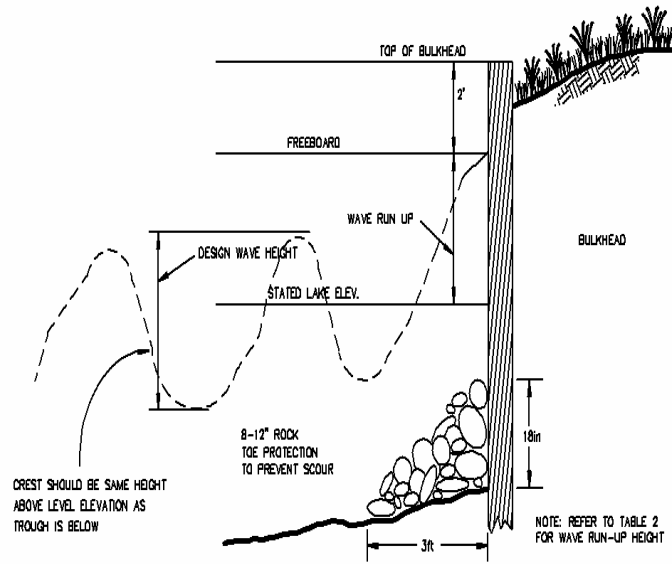
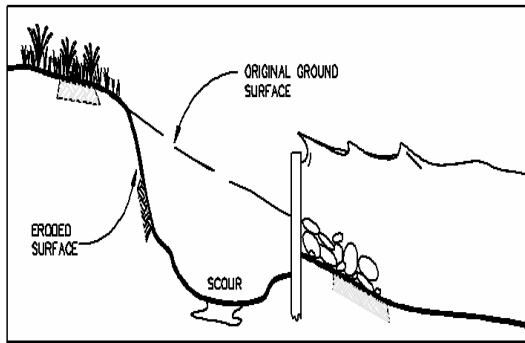

Figure F-2
VERTICAL PROTECTION
USING RETAINING WALL

Figure 6-2 Vertical Protection Using Retaining Wall

Figure F-3
 FAILED SHORELINE PROTECTION SYSTEMS



EROSION BEHIND STRUCTURE - WAVES LAP OVER TOP
 SIDE VIEW

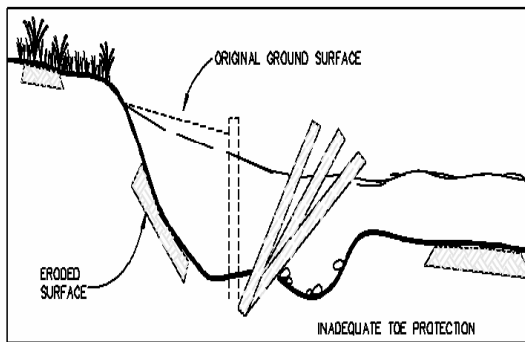

SLUMPING DUE TO TOE SCOUR
 SIDE VIEW

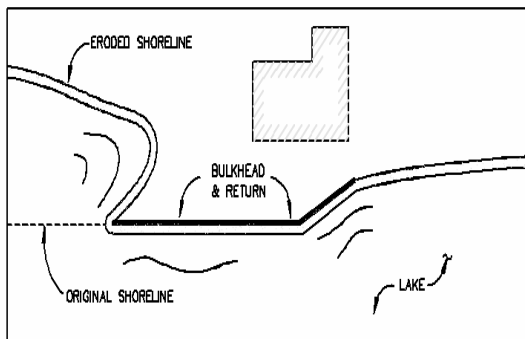

PLAN VIEW -- FLANK EROSION

Figure 6-3 Failed Shoreline Protection Systems

Figure 6-4 Determining the Cubic Yards of Dredged Material

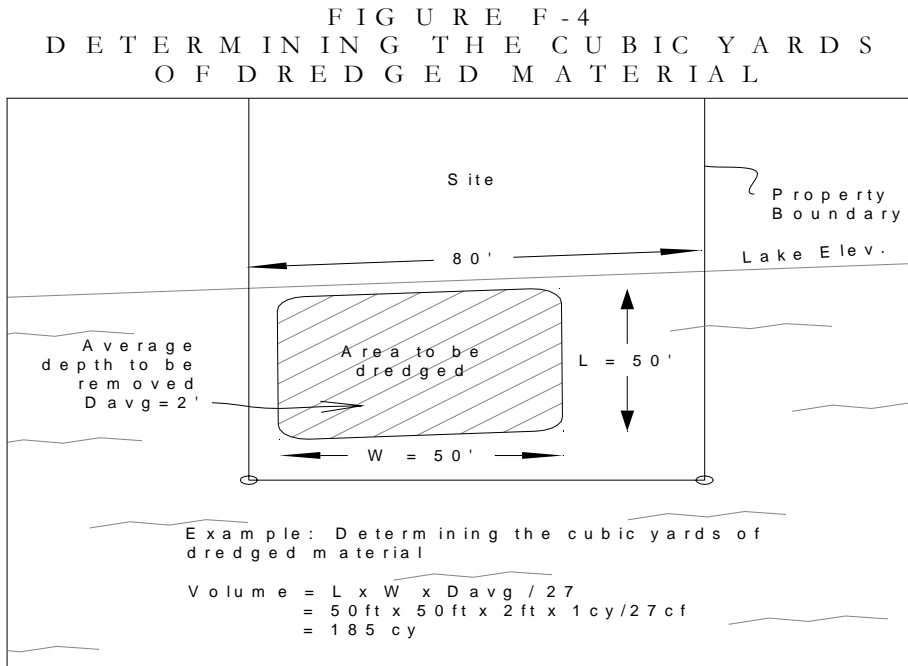

FIGURE F-5
CUT SLOPE FOR DREDGED AREA

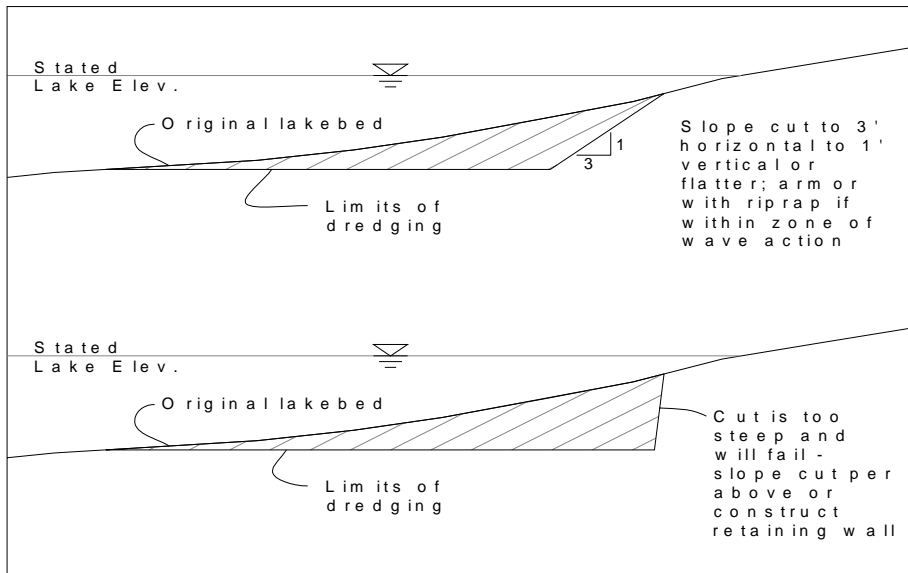

Figure 6-5 Cut Slope for Dredged Area

6-11 Enforcement of Dredge and Fill Standards

An agent or employee of LCRA may inspect dredge and fill activities in response to a complaint of possible violation of LCRA's Dredge and Fill Standards. LCRA will try to provide advance notification for inspections. The owner or owner's representative is encouraged to be present during an inspection. LCRA typically conducts inspections during normal LCRA business hours unless other arrangements are made.

When a violation of LCRA's Dredge and Fill Standards occurs, an authorized agent or employee of LCRA will issue a Notice of Violation stating the nature of the violation or violations. The notice will be provided by:

1. Posting in a prominent location on the site and
2. Sending a copy of the notice to the property owner, if known, by certified mail.

The property owner will have 30 business days from the date that the notice of violation is posted to comply with the standards. The property owner may submit to LCRA a written request for an extension of that time frame. In the written request, the property owner must explain in detail the need for additional time and what measures are being taken to correct the violation. LCRA staff has discretion to grant an extension of time; the approval will be in writing.

Nothing in LCRA's Dredge and Fill Standards prevents LCRA from seeking injunctive relief or another remedy in law or equity at any time against any person allegedly violating the standards.

When more than one entity imposes standards for dredge and fill activities, the rules that are more restrictive or impose higher standards or requirements are the ones that must be observed.

6-12 U.S. Army Corps of Engineers Requirements

In addition to complying with LCRA's Dredge and Fill Standards, you are required to comply with any other federal, state and local requirements, including Section 404 of the Clean Water Act. Under Section 404, you must have a permit from the U.S. Army Corps of Engineers (USACE) for any discharge of dredged or fill material into waters of the United States. The Highland Lakes, all streams that flow into the Highland Lakes, and wetlands that are adjacent to the above areas are examples of waters of the United States under Section 404. In some cases, you may be authorized to do work under a general permit without notifying the USACE. However, in many cases you must notify the USACE and receive either a verification of authorization under a general permit or an individual permit before beginning work.

For more information on USACE requirements, please see the USACE Web site listed below. You may also call or write the USACE Fort Worth District office.

U.S. Army Corps of Engineers, Fort Worth District
P.O. Box 17300, Fort Worth, Texas 76102
Phone: 817-886-1731
www.swf.usace.army.mil (click on “Permits”)

Please keep in mind that it is necessary to obtain permission from other government agencies (local, state, and federal) before beginning any work involving dredge and fill activities.

6-13 Lakewide Permit

In 1998 the USACE gave approval for LCRA to provide a Lakewide Permit that applies to repair work or minor dredging during a lake lowering on the Highland Lakes.

The Lakewide Permit remains in effect under the conditions of LCRA Dredge and Fill Standards. LCRA manages the Lakewide Permit process for the USACE. LCRA prepares packets with criteria specific to the Lakewide Permit, makes inspections of shoreline protection work, and files reports with the USACE in accordance with the permit.

Section II – Quarry and Mine Activity

Chapter 1

Permitting Requirements and Procedures

1.1 Introduction

This Chapter provides an overview of the permit status determination process found in the Highland Lakes Watershed Ordinance. Since the permitting processes were detailed in the Ordinance, this Chapter identifies the key issues to determine if a quarry or mine activity is exempt, requires written notice, or requires a certification or permit. For complete information on permit status, please refer to Appendix 1.1 to review the Highland Lakes Watershed Ordinance. Quarry and Mine permit types are found in Section 4, Subchapter B of the Ordinance. To determine the Highland Lakes Watershed Ordinance jurisdictional boundary, please refer to the map in Appendix 1.1.1.

1.2 Exemptions

The following are exempt from the provisions of the Ordinance and are not required to file an application, provide notification, or obtain a permit pursuant to the Highland Lakes Watershed Ordinance.

- Quarry or Mine Exploration
 - o Exploration by a owner or operator to obtain aggregate samples to determine the validity of a property as a quarry or mine. No submittals are necessary to LCRA, however, LCRA encourages the owner/operator to prepare a Stormwater Pollution Prevention Plan per TCEQ guidelines if total disturbance exceeds one acre of land.
- Quarry/Mine Acknowledgement
 - o A property that is owned or leased per the Ordinance requirements as of March 1, 2007 and has an active quarry or mine. LCRA encourages the owner/operator to coordinate with LCRA to gain an acknowledgement letter certifying the quarry operation status. In addition, LCRA can serve in a voluntary advisory role to provide recommendations toward the protection of water quality.

1.3 Written Notification Required

Owners or operators who plan to conduct quarry or mine activities that will create less than 10,000 square feet of impervious cover and will disturb less than five (5) acres of land and satisfy the other conditions found in the Section 4, Subchapter B (b) of the Ordinance will provide written notification to LCRA before commencing the activity. Quarry and mine activity that satisfies these conditions will not need to obtain a permit from LCRA. See the Ordinance in Appendix 1.1 for complete details.

1.4 Quarry/Mine Certification

A property that is **owned or leased as of March 1, 2007** and does not have an active quarry or mine and proposes quarry and mine activity that will disturb more than five (5) acres or will create more than 10,000 square feet of impervious cover shall submit an application pursuant to Section 6 Subchapter B and be subject to Section 5 Subchapter B and all other requirements of this Ordinance excluding Section 5 Subchapter A and Section 6 Subchapter A. See the Ordinance in Appendix 1.1 for complete details.

1.5 Quarry/Mine Permit

A property that is **owned or leased after March 1, 2007** and does not have an active quarry or mine and proposes quarry and mine activity that will disturb more than five (5) acres or will create more than 10,000 square feet of impervious cover shall submit an application pursuant to Section 6 Subchapter A and be subject to Section 5 Subchapter B and all other requirements of this ordinance excluding Section 5 Subchapter A. See the Ordinance in Appendix 1.1 for complete details.

Section II – Quarry and Mine Activity
Chapter 2
Meeting Water Quality Protection Performance Standards

2.1 Introduction

The LCRA’s Highland Lakes Watershed Protection Ordinance requires the management of stormwater runoff from quarry and mine activity through the implementation of best management practices (BMPs). In many cases, the quarry or mine will rely on the excavated pit to serve as the primary BMP. Water quality protection guidance is provided for site activities that drain to the pit as well as those portions of the site that drain away from the pit.

Quarry and mine activities which must comply with these standards include a site where aggregates will be removed or extracted from the earth to form the pit or mine, including the entire excavation, disturbed areas, haulage ramps, parking lots, storage areas, and the land under ownership, lease, or mineral rights immediately adjacent thereto upon which the plant processing the raw materials is located. Refer to Appendix 1.1 to review the Ordinance and its application to your project.

The Highland Lakes Watershed Ordinance contains five (5) performance standards for water quality management and are summarized in the Table 2-1.

Table 2-1
Summary of Performance Standards
Quarry and Mine Activity

Performance Standards	Ordinance Section 5 Subchapter B	Minimum Requirements
Pre-Quarry/mine Planning	(a)	Meeting with LCRA staff
Water Quality Management	(b)	Surface water protection through BMPs
Buffer Zones	(c)	Delineate buffer widths on creek per Ordinance criteria
Land Disturbance Erosion and Sediment Control	(d)	Land disturbance erosion control plan per TCEQ SWPPP
Ground Water Quality Protection	(e)	Groundwater protection through monitoring and design
Reporting	(f)	Reporting requirements

2.2 Pre-Quarry/Mine Planning

Pre-quarry/mine planning is the important first step in all projects. Section 5, Subchapter B (a) in the Highland Lakes Ordinance states:

A concept plan meeting shall occur for all Quarry/Mine Projects that are subject to obtaining a Certification or Permit per Section 4, Subchapter B (site that do not have an active quarry or mine, and proposes quarry or mine activities that will create more than 10,000 square feet of impervious cover or will disturb more than five (5) acres of land). The meeting should focus on potential disturbed area, slopes, buffers, water diversions, water quality management practices, and may include a site investigation. No submittals are required at this meeting. This meeting can aid the applicant in determining ordinance requirements and conditions prior to extensive effort in preparing a water quality protection plan. **A Quarry/Mine Permit or Quarry/Mine Certification application can only be submitted after the completion of this task.**

Additional guidance for preparing an application is found in the LCRA Technical Manual. If applicable, the owner/applicant should contact the local Groundwater Conservation District of the plan to initiate a quarry facility.

To prepare for the planning meeting, components of the pre-development planning checklist (Appendix 2-5) can be used such as buffer zone delineation, property map, aerial photographs, topographic maps, soils maps, etc to aid in defining potential water quality plan components. This checklist is used as a quick reference to aid in planning, not a list of requirements for a quarry or mine. Sound land use planning is the most important step in managing the site activity and avoiding runoff problems during the quarry/mine duration. Site planning can then proceed to minimize drainage impacts, avoid the concentration of flow to the maximum extent practical, and use the natural topography and vegetation to manage stormwater runoff when not draining to the pit.

Once the pre-quarry/mine plan is prepared, the owner/operator will need to coordinate with LCRA to convene a pre-quarry/mine planning meeting. The necessary submittals for a quarry/mine permit or certification will be determined in this meeting. LCRA may require an applicant to submit certain information dependent upon the site conditions, planned quarry or mine activities, size of quarry or mine, and depth of excavation. LCRA will make a determination based upon sound science and professional standards for the appropriate permit or certification submittals determined after this planning discussion with the applicant. A list of potential submittals can be found in 2.3. Upon completion of the meeting, LCRA will provide a letter to the applicant confirming that a meeting was held.

2.3 Water Quality Management

Water quality management is provided for the protection of creek and lake water quality and drainage-ways from channel erosion. This chapter presents the methodology and potential submittal documents to demonstrate surface water quality protection at a

planned quarry or mine site. In most cases, operators of quarries and mines desire to retain stormwater within the pit to aid in material processing, dust suppression, and other activities at the site. Therefore, two approaches were developed for the management of surface water quality and are described in the following sections.

2.3.1 Stormwater from Project Area Not Draining to the Pit

For portions of the project area that will not drain to the pit and include roads, buildings, parking lots, and vehicle/equipment maintenance shop areas not containing exposed material stockpiles, water quality design and assessment shall be performed per Section I, Development Activity, Chapter 2.3 to determine and size appropriate BMPs. Section, I, Chapter 4 is used in combination with the previously referenced chapter to select and include the necessary design components for the successful implementation of surface water quality protection BMPs. This is the same approach used by development projects to demonstrate water quality protection through the management of the one-year, three-hour storm. In addition, standard development (roads, buildings, parking lots, lawns, etc.) for mine and quarry projects can use Low Impact Development methodologies as identified in these chapters to reduce or avoid stormwater storage volume requirements. Also, standard development less than three acres can pursue compliance with Commercial Development Alternate Standards found in Section I, Chapter 2.3.1. A BMP Maintenance Plan shall be prepared for these water quality management facilities per Section I, Chapter 5.

For areas of exposed material stockpiles, disturbed areas, and operational areas not draining to the pit, the quarry or mine project shall provide water quality volume in BMPs found in the Section I, Chapter 4 (Permanent Structural BMPs). The required water quality volume for the selected BMP(s) must be equal to the runoff volume from a 10-year 24-hour storm as defined below.

10-year, 24-hour precipitation rate = 6.5 inches (source TP-40)

The water quality volume can be computed by the use of the Rational Method (drainage areas less than 100 acres), Soil Conservation Service TR-20 or TR-55 methods, HEC-HMS, or other methods approved by LCRA. The design shall be prepared and sealed by a registered licensed engineer in the State of Texas and be based upon the anticipated fully developed runoff conditions.

A spreadsheet design tool is included in the front pocket of this manual to aid in computing runoff volume and water quality basin storage requirements.

2.3.2 Stormwater from Project Area Draining to the Pit

For portions of the project area that drain to the pit and include roads, buildings, parking lots, disturbed areas, and exposed stockpile storage areas, the applicant must demonstrate that for the pit to be used as a permanent BMP it must be of sufficient size to contain the runoff volume from the 10-year 24-hour storm without discharge during such a rain

event. The runoff volume is derived from contributing drainage area to the pit and computed by the use of approved hydrologic methods based on soil, vegetative cover, and anticipated fully developed runoff conditions. The applicant may select to use diversion berms, swales, and other approved methods found in Section I, Chapter 3 of this Technical Manual to divert water away from or direct water to the pit. Berms, swales, and other selected conveyance systems shall be designed to convey the runoff from the 10-year 24-hour storm with a minimum of one-foot of freeboard to minimize overtopping. Due to the ongoing nature of the pit expansion and the desire of the operator/owner to gain release of the letter of credit, the applicant may be required to submit the size and depth of the quarry pit during the initial mining phases that will contain the 10-year, 24-hour storm runoff from the contributing drainage area. In addition, the applicant must also demonstrate that the final pit size will contain the 10-year, 24-hour storm runoff.

The applicant will utilize temporary and permanent BMPs as described in Section I, Chapter 3 of this manual to limit sediment discharge into karst features. Rapid re-vegetation and stabilization of disturbed areas will best serve this purpose.

When a recharge feature with a surface opening greater than one square foot in area is found on the floor of the quarry or mine, it should be sealed or protected in order to prevent sediment from infiltrating with stormwater runoff. Methods that can be used to seal recharge features include:

- 1) Concrete plug in accordance with TCEQ Technical Guidance RG-348 and TCEQ Optional Enhanced Measures (Appendix to RG-348).
- 2) Other methods prepared and sealed by a licensed professional engineer in Texas.

2.3.3 Other Local, State, and Federal Regulations

In many cases, the quarry or mine will need to comply with other regulations to demonstrate water quality protection. In order to protect water quality LCRA will rely on the required activities by other regulatory agencies to aid in the protection of water quality. The applicant shall provide LCRA with copies of, or access to all plans, reports, and approvals from other regulatory agencies, including, but not limited to, the following:

EPA – NPDES permit, Spill Prevention Control, Containment, and Countermeasures
MSHA/OSHA- Hazard Communications Plan
US Army Corps of Engineers – 404 permits and/or letters of permission if necessary
TCEQ – TPDES Industrial Sector Permit, Multi-Sector General Stormwater Permit and Stormwater Pollution Prevention Plan
TPWD – Marl, Sand, and Gravel Mining in Public Waters of the State

If applicable, the applicant shall provide documentation of compliance with a Groundwater Conservation District Requirements.

2.3.4 Potential Submittals to LCRA

As mentioned in 2.2 above, LCRA may require an applicant to submit certain information dependent upon the site conditions, planned quarry or mine activities, size of quarry or mine, and depth of excavation. The necessary submittals will be used to determine drainage areas, compute runoff volume and discharge rates, prepare designs of selected BMPs and conveyance systems, indicate limits and depth of the planned activity, identify creek crossings, delineate floodplain limits, identify monitoring locations, and prepare general reclamation guidance among other items. The potential submittals based on the planned activity include the following:

Hydrologic Report

A report prepared by a licensed professional engineer in Texas that will define impoundments, streams, floodplains, and proposed drainage diversions including water quality BMPs within the proposed mine or quarry property boundary. Channels, swales, diversion berms that convey stormwater runoff shall be designed to pass the 10-year 24-hour storm peak runoff rate with one-foot of freeboard.

The plan shall include sheet(s) at an appropriate scale and in sufficient detail to clearly depict the hydrology plan and other features. Items to include in the report include:

- Description of site and scale of proposed activities
- Existing topography
- Location and type of soils. This information can be obtained from the County Soil Survey.
- Proposed grading and drainage patterns including drainage area maps for any offsite contributing areas (may be larger scale map as needed)
- Data and calculations for water quality BMPs and associated drainage facilities, including drainage area, impervious cover area, disturbed and natural areas, time of concentration, runoff coefficients or curve numbers and peak discharge and volume for the 1-year and 10-year storm events (used to size BMPs for areas draining to and away from the pit and conveyance systems), volume calculations for all ponds, floodplain/floodway calculations for fully developed conditions or FEMA floodway delineation when used to define a buffer zone.
- Description of the BMPs to be implemented to achieve the performance standards for Water Quality Management.
- Location and schematic of proposed BMPs

Suggested minimum scale of 1"=100' for tracts under 100 acres, 1" = 200' for tracts 100 to 250 acres 1" = 400' for tracts 250 to 400 acres, and 1" = 1000' for larger tracts. Suggested contour line interval of 2' intervals for projects up to 400 acres or 5' intervals for projects greater than 400 acres. Offsite areas can utilize USGS topographic maps at a scale of 1"= 2000' to delineate drainage area boundaries.

Hydrogeologic Report

A report prepared by a licensed professional geologist in Texas containing the aquifer identification, aquifer characteristics, drastic classification, recharge zones, any known or identified karst features offsite (does not require offsite field investigation), identification of karst sites onsite via field reconnaissance, depth to water on the site, well inventory and/or springs within one mile of proposed mine or quarry property boundary and identify measures to protect groundwater recharge. The applicant will demonstrate compliance with setbacks from recharge features and public water supply wells according to the TCEQ source water protection program and if applicable, Groundwater Conservation District requirements. Identified springs, wells, recharge zones and other features can be shown on the maps prepared for the hydrologic report discussed above. If prepared on a separate map, the map scale should follow hydrologic report map scale guidance.

Karst Identification Process:

- 1) Literature search for geologic and groundwater reports, maps, and other references that would help determine if the proposed operation is in a karst area, recharge zone or discharge zone, including Internet searches of the Texas Water Development Board, U.T. Bureau of Economic Geology and U.S. Geological Survey web sites.
- 2) Study of topographic maps and aerial photography (including multi-spectral imagery if available) for indications of depression contours, sinkholes, disappearing streams, mapped wells, springs or seeps, tunnel or cave entrances, mine shafts, quarry or open pit mines, gravel or borrow pits, prospects, tailings or mine dumps, faults, scarps, linear and perpendicular topographic features, and/or highly reflective areas on infrared images indicating phreatophytic vegetation.
- 3) Field reconnaissance by a qualified Texas professional geologist, including a walk-through of the property to inspect for the above listed features.
- 4) Study of any available well logs, boring logs, core samples or drillers reports for reference to voids, open spaces, caves, caverns, water producing zones, static water levels.
- 5) LCRA may request to inspect these documents, but not retain any proprietary information.

Quarry or Mine Plan

A plan shall be prepared showing the proposed mine or quarry boundaries, property limits, mining limits, approximate mining depths, drainage plan, creek crossings, diversions, a list of BMPs proposed for mined out areas as temporary sedimentation basins, and the type of mine or quarry proposed. Again, these features can be shown on the hydrologic report maps or at the map scale identified above if on a separate sheet.

Surface Water Monitoring Plan

A plan will be prepared to supplement the TCEQ Multi-Sector General Stormwater Permit requirements. The owner/operator can use the TCEQ Multi Sector General Stormwater Permit as the plan, but shall monitor four (4) events per year, weather permitting, and provide data in the annual report. Parameters tested in the monitoring plan may include but are not limited to Total Suspended Sediment, pH, oil and grease, and Total Organic Carbon. The plan shall include the location of the monitoring sites, which must be at all discharge points from the quarry or mine activity. The monitoring locations can be shown on the hydrologic report map.

In addition, quarry owners may monitor water quality of streams flowing through the property, both upstream and downstream of quarry operations. If so, these data should include measurements of streamflow. The data may be used to establish baseline or pre-existing conditions, and/or showing that quarry operations may not be the only cause of water quality problems.

General Reclamation Guidance Plan

A plan shall be prepared to illustrate potential final measures to protect water quality and maintain ordinance compliance once the mining and quarrying activities are complete. The plan should include guidance on vegetative cover of disturbed areas outside the pit within one-year of completion of excavation except on quarry walls, quarry floor, and flooded areas. Additional guidance on vegetative cover can be found in Section I, Chapter 3 of this report. The plan shall be prepared on a scale identified in the hydrologic report above and demonstrate management of the following items:

- Areas that drain to the pit are stabilized or demonstrate that the volume of the pit can provide storage of the 10-year, 24-hour storm,
- Areas that do not drain to the pit are vegetated and stabilized,
- Areas that drain to constructed BMPs are vegetated and stabilized,
- BMPs are cleaned and inspected per the BMP Maintenance Plan identified in Section II, 2.3.1,
- Provide guidance on final inspection and completion of plugs or other devices that prohibited recharge to the local aquifer
- Processing and storage areas are cleaned and vegetated, and
- Reclamation of structures occurs as necessary within one year of completion.

In order to ensure that uncontaminated material is used as backfill, the guidance plan should include information from TCEQ's Rule Interpretation Summary Form 330-4.001. In addition, quarry operators should consult TCEQ Landfill Site Selection Technical Guidance Number 2 to determine if a mine or quarry would qualify as a proper site for non-hazardous solid waste disposal.

Once a Mine or Quarry operation is complete or has been abandoned, any subsequent Development will be subject to the conditions and terms of the Highland Lakes Watershed Ordinance, as amended, to protect water quality.

2.3.5 Groundwater Quality Protection

Quarries and mines have the potential to impact groundwater quality if activities within the quarry/mine lead to pollutants discharging to the groundwater. Proper management of activities during the excavation and mining period are necessary to ensure the protection of groundwater resources. Since all quarries and mines are different, and can be located in different geologic strata, the following may be required to protect and monitor water quality:

Proposed Plan

Based on proposed activity, site conditions, hydrogeologic report, and other submittals in Section II, Chapters 2.3.3 and 2.3.4, LCRA may require monitoring wells for water levels and water quality determination including background and down-gradient conditions. The sample frequency will be proposed by the applicant and approved by LCRA during the permit application process, based on professional practices regulated by the Texas Board of Professional Geoscientists and/or the Texas Board of Professional Engineers. A groundwater sampling plan will be prepared and parameters may include but not limited to water level or flow, pH, nitrate-nitrogen, Total Suspended Sediment, Volatile Organic Carbon, Total Organic Carbon and Total Dissolved Solids. If a groundwater district has jurisdiction, the sampling plan shall be designed to comply with the district guidelines.

Background Conditions.

Background conditions may be established by adoption of historical data at existing wells or springs or by data collected by the applicant during operations, and/or by installation of monitoring wells and sampling of wells and springs up-gradient from the mine or quarry. Professional standards will be followed such as those set out in the “Handbook of Suggested Practices for the Design and Installation of Ground-Water Monitoring Wells” (EPA, 1991.). LCRA can provide an electronic copy of this document upon request.

Generally, groundwater monitoring should be conducted for one year prior to quarry operations to establish background conditions. Quarterly samples shall be collected. Field parameters (temperature, pH, electrical conductivity) should be measured and allowed to stabilize prior to sample collection. Samples may be collected by capturing flow, bailing, or pumping.

Down-gradient Conditions

Down-gradient conditions may be monitored at wells and/or springs that could potentially be affected by quarry operations. New or existing wells may be used with well screens set at the appropriate interval recommended in the applicants’ hydrogeologic

report. Spring flow may be monitored at the spring outlet or by measurements and samples taken upstream and downstream of the spring. Monitoring sites should be selected at locations that would isolate the effects of mining from other activities, if possible.

Design of Groundwater Protection

The data and information developed in the above sections will be used to determine appropriate BMPs to protect groundwater quality, including structural and non-structural best management practices. These BMPs can be located up-gradient of the pit or within the pit to limit discharge to the aquifer. Also, when a recharge feature with a surface opening greater than one square foot in area is found on the floor of the quarry or mine, it should be sealed or protected in order to prevent sediment from infiltrating with stormwater runoff. Quarry operators should comply with TCEQ Technical Guidance RG-348 and TCEQ Optional Enhanced Measures (Appendix to RG-348), or other methods prepared and sealed by a licensed professional engineer in Texas.

Operation Phase, Mitigation

If sampling per the above monitoring plan verifies a contamination or potential contamination of ground water quality as a result of the Quarry/Mine activity, the Owner/Operator shall prepare a mitigation plan for LCRA approval within 30 days of notification from LCRA. Implementation of the mitigation plan shall occur within 60 days of LCRA's approval of the plan. Mitigation plans could include the following components:

- Demonstration that groundwater contamination is at or below Maximum Contaminant Levels (MCLs) set by EPA and/or TCEQ.
- Demonstration that groundwater contamination will remain on site and not migrate to adjacent properties.
- Demonstration that capture, removal, in-situ treatment or attenuation will mitigate groundwater impacts.
- Demonstration of due diligence and communication with government agencies, groundwater conservation districts and nearby landowners.

Reclamation/Closure

Once the Quarry or Mine operation is properly closed/reclaimed, the monitoring plan established per the above guidance can be terminated with proper closure and protection of all monitoring wells per the Texas Department of Licensing and Regulations Water Well Drillers Rules (Water Well Drillers located in the Texas Administrative Code and the statutory requirements of Chapter 1901, Texas Occupations Code, Title 12. Practices and Trades Related to Water, Health, and Safety).

2.4 *Buffer Zones*

Section 5, Subchapter B (c) of the Highland Lakes Watershed Ordinance identifies the buffer zone requirements. Buffer zones protect waterways and aquatic resources from the short and long term impacts of land disturbance. Buffer zones shall remain free of construction, development, or other alterations except for utility and roadway crossings. The number of crossings through buffer zones should be minimized. No stormwater treatment facilities, golf courses, or wastewater irrigation shall be located in the Buffer Zone. Stormwater, water quality basin, and pumped discharges from the pit shall be dispersed into overland patterns before reaching the buffer zone.

Buffer zones are required on creeks or swales that have more than 320 acres of contributing drainage area. To protect the creek buffer, stormwater discharged from water quality basins and the pit must enter the buffer in a sheet flow manner. By-pass flows from storms in excess of the basin design storm must be conveyed in a stable manner through the buffer zone to the receiving water body. This can be accomplished through application of the outfall stabilization and level spreader systems presented in Section I, Chapter 3. Some limited vegetation management is allowed within the buffer zone to enhance the character of the buffer; however, this effort must be approved by LCRA before commencement. Additional information relating to the buffer zones can be found in Appendix 2.6.

As defined in the Highland Lakes Watershed Ordinance, a creek is a well-defined channel that can convey running water. This definition will be used to determine the beginning or upper-most headwater of the creek to initiate the application of the buffer zones.

- (1) For Creeks or rivers draining more than 320 acres, the Buffer zone shall be a minimum width of twenty-five (25) feet from the top of the channel bank (as determined in hydrologic report) on each side of the creek/river. However, if the floodway boundary is beyond twenty five (25) feet from the top of the channel bank, the buffer zone shall be established at the floodway limit. The floodway may be determined from Federal Emergency Management Agency information or by an engineering study that is signed and sealed by a registered, licensed engineer. If the floodway is determined by an engineering study, the floodway shall be based on the fully developed conditions for the 100-year flood as approved by LCRA.
- (2) Management of the Buffer Zone through LCRA's Creekside Conservation Program and other programs is encouraged to develop healthy and dense buffer areas that improve water quality protection and groundwater recharge. Refer to the LCRA Technical Manual for guidance on riparian corridor management.
- (3) Sand and gravel operations obtaining a Texas Parks and Wildlife Department Sand, Gravel, Shell, and Marl or US Army Corps of Engineers authorization may be eligible for a variance from the buffer zone requirements found in this

ordinance. The applicant shall submit the authorization from these agencies to LCRA during the application review process. LCRA will consider the above agency authorization and permit conditions and may provide additional permit conditions pursuant to this ordinance to minimize turbidity caused by the activity and verify that appropriate BMPs will be in place to minimize the discharge of sediment, gravel, and other materials to the receiving water body.

QUARRY & MINE BUFFER ZONE

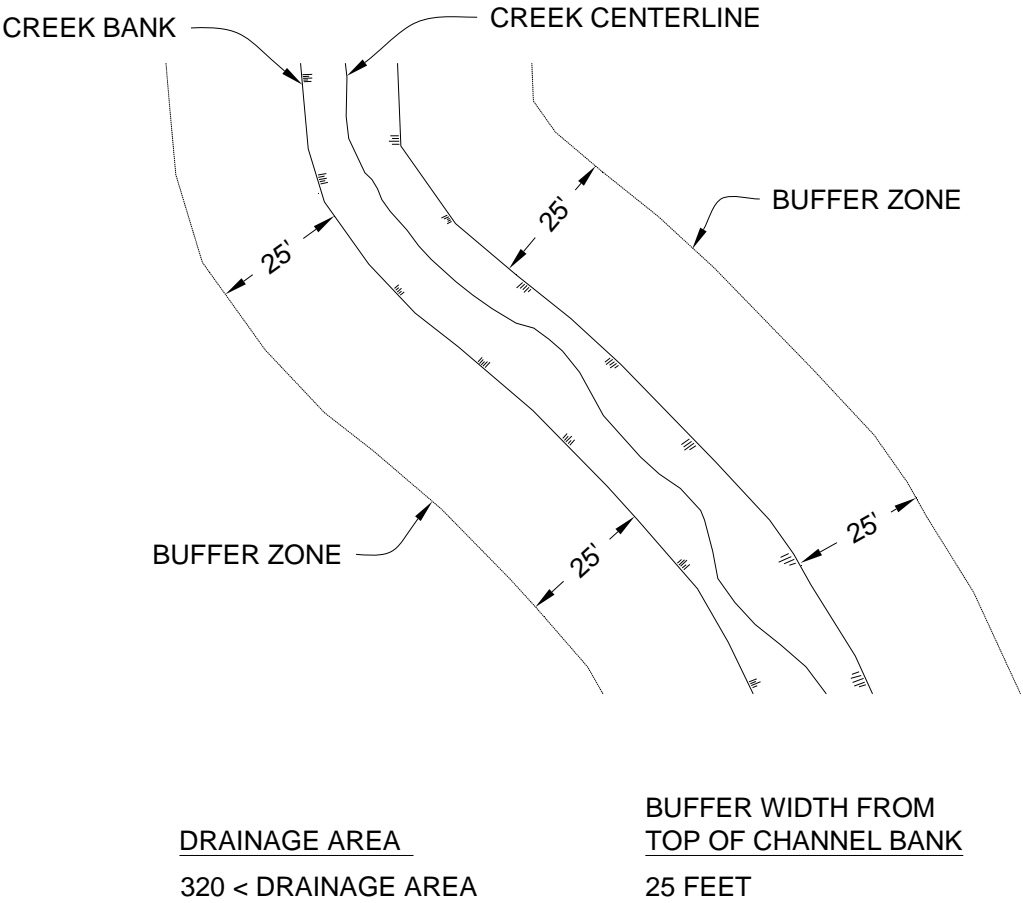

Figure 2.1: Buffer Zone Schematic (for drainage areas greater than 320 acres)

2.4.1 Buffer Zone Technical Requirements

- Delineation of the buffer zone on all plan sets, including clearing, grading, and quarry/mine plans.
- Installation physical barriers (e.g., fencing or other barriers) along the buffer zone boundary *prior* to any clearing, grading, or pit excavation activities.

It is recognized that there may be some necessary impacts to the buffer. The following disturbances may be allowed in the buffer zone, the following criteria should minimize these impacts.

- *Roadway Crossings:* Road crossings of creeks should be minimized. Grading, including cut and fill, should be reduced to a minimum. Open sections and swales should be used and concentration of flows into large pipes or outlet structures should be minimized. Where possible, sheet flow will be directed to buffer zones in order to take advantage of the pollutant filtering potential of the buffer. The roadway design should consider long-term channel and bank stability and habitat and use appropriate techniques to manage anticipated long-term channel adjustments. See Section I, Chapter 3.3.16 for additional details.
- *Utility Crossings:* Grade controls and bank stabilization should be placed at all crossings of drainage ways. For those utilities that do not require continual access, replacement and revegetation with in-kind native plants is recommended. Utility crossings should occur at or near right angles to the maximum extent practical. The utility design should consider long-term channel and bank stability and use appropriate techniques to manage anticipated long-term channel adjustments. See Section I, Chapter 3.3.16 for details.
- *Storm Drainage Outfalls:* Direct connection of shallow concentrated flow, open channel flow and storm drain pipes to the stream channel through the buffer shall be avoided. Energy dissipation devices, such as on-contour level spreaders, infiltration trenches, vegetated filter strips, rock trenches, inverted weirs or other permanent BMPs shall be placed outside of the buffer to produce sheet flow. After the stormwater energy is diffused before entering the buffer, the resultant runoff should enter the receiving channel at non-erosive velocities as shallow concentrated flow.

Rock riprap of sufficient size should be placed downstream of the storm drain outfalls to manage scour and protect the outfall structure. Designers should refer to Chapter 3 to determine rock size and apron length.

- *Level Spreaders:* A level spreader typically is an outlet designed to convert concentrated runoff to sheet flow and disperse/dissipate its energy uniformly across a slope to prevent erosion. Level spreader systems are presented in Section I, Chapters 3 and 4.

2.5 *Erosion and Sediment Control*

Erosion and Sedimentation shall be controlled throughout the Quarry and Mine process in accordance with the EPA and TPDES Stormwater Pollution Prevention Plan and the BMPs found in Section I, Chapters 3 and 4 in this manual. Due to the long-term nature of quarry and mine activities, the use of constructed diversion channels, swales, and berms may be the most appropriate long term stable conveyance methodology. Guidance can be found in Section I, Chapter 3 on the design and implementation of these conveyance systems. Channels, swales, and berms must be designed to convey the runoff from a 10-year 24-hour storm with one-foot of freeboard. Operational berms or swales used to convey processed water are not required to comply with the 10-year, 24-hour storm design requirements. In addition, berms around the pit perimeter designed to serve as sediment control, not stormwater retention, do not need to demonstrate compliance with the 10-year, 24-hour storm design requirements.

- (1) Development of and adherence to a SWPPP shall be considered to meet the requirement for erosion and sedimentation control. The Permittee shall make the SWPPP inspection records and reports available to LCRA upon request. Inspection and maintenance of temporary erosion controls shall be performed in accordance with the SWPPP which was included in the submittals to LCRA per Section II, 2.3.3
- (2) Prior to the commencement of quarry and mine activities, LCRA will provide training materials to the owner/contractor. LCRA will meet with the owner/contractor and review the training materials and inspect the temporary erosion controls at the time quarry and mine activities begin.

To minimize sediment transport, site disturbance should be done in a manner to direct stormwater runoff to the pit and stabilize all areas not draining to the pit as soon as possible. The most effective erosion control is the minimization of disturbed area. When this practice is combined with rapid re-vegetation of disturbed areas, the receiving water bodies can be protected from sedimentation. Final stabilization of soil disturbing activities are considered complete when perennial vegetative cover reaches 70% density of the native background vegetative cover for the area. Permanent BMPs must achieve a density of 80% vegetative cover to be considered complete. For some locations, final site stabilization of an area may include the existing buildings, parking lots, and paved roads that are not demolished.

This section outlines the necessary steps for creating an effective erosion and sediment control plan. Details for individual erosion and sediment control BMPs can be found in Section I Chapter 3.

- a. Assess the drainage characteristics and planned site disturbance. This process should identify:
 - Patterns of stormwater flowing over the site including off-site sources, sub-drainage areas, sheet-flow areas, concentrated flow areas and exit points.

- Location of proposed cuts and fills, and disturbance areas, and assessment of construction relating to initial, interim and final drainage.
 - Necessary access points.
 - Limits of non-disturbance area.
 - Construction equipment storage areas.
- b. Determine the location of the temporary erosion controls including:
- Locate controls as close to disturbed areas as possible allowing room for construction activities and maintenance of controls.
 - Assure there are no breaks or points where runoff can bypass or short-circuit the temporary erosion controls.
 - Locate controls so as not to create off-site flooding of adjacent properties.
- c. Based on steps A and B, the category or function of controls and their phasing should be determined to reflect the disturbance sequence and changing drainage patterns.
- d. Finally, the designer must determine specific controls to be shown at the locations chosen in step C.
- e. Perform an adequacy check to determine compliance with the following items:
- Controls used are within the allowable drainage area limits.
 - Controls are located perpendicular to the runoff flow.
 - Detention controls are shaped to create adequate areas for ponding and sediment accumulation.
 - Install detention/filtration controls along contours to promote spreading of runoff.
 - Locate controls in low traffic areas that are easily accessible for maintenance.
 - Controls should be phased as necessary to reflect changes in drainage patterns to remain effective throughout the construction period.
 - Locate controls in areas that will not cause flooding of adjacent properties.

Additional guidance on construction sediment management can be found in Appendix 2.7.

To aid in the proper selection of erosion control and stabilization techniques, Table 2-2 presents typical erosion site characteristics and the accompanying BMPs.

**Table 2-2 Erosion Control Selection Guidance
Suggested Techniques to Minimize Soil Erosion**

Site Characteristics	Management Approach	BMP Tools	Comments
Disturbed Area > 5 acres	Limit disturbance, control access to non-construction areas and buffers	Temporary Fencing to control access Berms Sediment Basins	Identify disturbed and protected areas on the construction plans
Slopes > 10%	Limit construction on steep slopes, stabilize immediately	Silt Fencing Rock berms Compost/mulch/seed	Seed and vegetate as soon as possible, use soil protection blankets or compost-seed mixes.
Soils – clay/silt	Minimize excavation, cover/vegetate immediately	Silt Fence Blankets & Matting Compost/mulch/seed Sod/seed	Difficult to settle soil particles, minimize disturbed area
Vegetative Cover < 50%	Minimize disturbance in this area, enhance vegetation	Seed Sod Compost/mulch/seed	Promote rapid vegetation growth
Off-site Drainage Area > 5 acres	By-pass runoff around site, or convey in stable manner	Diversion Dikes Interceptor Swales Pipe/slope Drain	Maintain diversion BMPs during construction to prevent sedimentation of devices
Duration > 6 months	Phase construction disturbance, stabilize disturbed areas	Vegetation Blankets & Matting	Develop construction disturbance and re-vegetation plan as part of construction sequence
Road Crossings of Drainage ways	Minimize crossings, stabilize road cuts as soon as possible	Temporary Sediment Basins	Basin size – 1,800 cubic feet per disturbed acre drainage to basin
Distance < 100 feet from drainage	Relocate disturbed areas beyond the buffer zone limits	Silt Fence Rock Berms Sediment Basins	Identify creek buffer zones, perform work and maintain stockpiles outside of this zone

2.6 Reporting

All records required by the LCRA Quarry/Mine Permit and other agencies shall be kept onsite while the facility is in operation. If monitoring is performed for LCRA or other agencies, annual monitoring reports will be submitted to LCRA. LCRA may perform site reviews on a quarterly basis and provide reports to the quarry operator/owner within five (5) days of review. LCRA will meet annually with the quarry operator/owner to obtain reports and may include potential permitting review. This meeting may coincide with the annual inspection of permanent water quality BMPs.

Reports to be provided include:

TCEQ Stormwater Pollution Prevention Plan

TCEQ Multi-sector Industrial Permit – discharge monitoring

EPA SPCC Plan

Site reviews on a quarterly basis will be performed per Section I Chapter 5 Permanent BMP Maintenance Guidelines and Chapter 3 Erosion and Sediment Control Best Management Practices.

Glossary

Acre: A unit of area equal to 43,560 square feet.

Active Quarry/Mine: A Quarry or Mine that is in Continuous Operation or as determined on a case by case basis by LCRA during the annual investigation in cooperation with the owner/operator.

Adjacent Property Owner: A Landowner or Land User whose property line, or any portion thereof directly borders or touches a property line belonging to the property, or properties, for which the LCRA has received an application for a Permit pursuant to this Ordinance.

Affected Person: Any Person who has a personal, justiciable interest and whose legal rights, duties or privileges may be adversely affected by Stormwater Runoff Pollution from any proposed Development for which a Permit is required under this Ordinance.

Aggregate: Any commonly recognized construction material originating by the disturbance of the surface, including dirt, soil, rock asphalt, clay, granite, gravel, gypsum, marble, sand, shale, stone, caliche, limestone, dolomite, rock, rip rap, dimension stone, minerals, or other similar substance.

Agricultural Activities: All activities associated with the production of livestock or use of the land for planting, growing, cultivating and harvesting crops, or participating in a wildlife management plan.

Alternate Standards: Requirements that may apply to a Single-family Subdivision Development or Commercial Development meeting the performance standards found in Section 5(b)(2)(i) and (ii) of the Ordinance.

Applicant: A Landowner or Land User (or their duly authorized designee) who applies for a Permit under this Ordinance.

Best Management Practices (BMPs): Those practices, including but not limited to those described in LCRA's Technical Manual that effectively manage Stormwater Runoff quality and volume.

Best Management Practice (BMP) Maintenance Permit – A Permit for the maintenance of BMPs.

Buffer Zone: Vegetated area free of Impervious Cover adjacent to a Creek, river or natural drainageway.

Cluster Development: A confined area of housing or Commercial Development that is separated from other Development areas by undeveloped land.

Colorado River Watershed: All area draining into the Colorado River in Texas.

Commercial Development: All Development other than open space, a Single-family Residence, or Single-family Subdivision Development.

Continuous Operation: A Quarry or Mine where surface or subsurface Excavation, stockpiling, Quarry and Mine site improvements, sales of material, shipping of material, processing and/or reclamation has occurred within the past one (1) year by the Quarry/Mine Owner or Operator.

Creek: A well-defined channel that can convey running water.

Cut: A portion of land surface or area from which the earth has been removed by excavation.

Development: All land modification activity, including the construction of buildings, roads, paved storage areas and parking lots for single-family subdivisions, multi-family, retail, medical, educational, and Commercial Development. Development also includes, but is not limited to, any land disturbing construction activities or human-made change of the land surface including clearing of vegetative cover, excavating, leveling, grading, contouring, and the deposit of refuse, waste, or Fill. Care and maintenance of lawns, gardens, and trees, minimal clearing (a maximum of 15 feet wide for development project surveying and testing and 20 feet wide for quarry exploration), and Agricultural Activities are excluded from this definition.

Development Permit – A Permit for Development of land within the jurisdictional area specifically addressing Best Management Practices for control of Stormwater Runoff Pollution resulting from Development. Development Permits may also address the installation of utility infrastructure by private Landowners and Land Users.

District: LCRA's 10-county statutory District, comprised of San Saba, Llano, Burnet, Blanco, Travis, Bastrop, Fayette, Colorado, Wharton and Matagorda counties.

Disturbed: The land surface that is modified by activities such as clearing, grading, filling, and Excavation.

Dredge: The removal of material from below the stated normal conservation pool elevations of the lakes.

Erosion: The detachment and movement of soil, sediment or rock fragments by wind, water, ice or gravity.

Excavation: The removal of earthen material, rock, or soil to create a depression below the original topography. When used in reference to a Quarry/Mine, the removal of said material in a commercially significant quantity.

Existing Development: Any completed Development and any property that has obtained final plat approval from a governmental entity prior to February 1, 1990, in the Lake Travis Watershed in Travis County or March 19, 1992, in Llano County or Burnet County in the Colorado River Watershed as reflected in Attachment 2. Provided that a property has not been replatted after February 1, 1990 in Travis County and March, 19, 1992 in Burnet and Llano Counties.

Existing grade: The grade that exists prior to land disturbance.

Exposed cut: A cut that, upon completion of excavation, remains visible beyond the boundaries of the site or lot on which the cut is located.

Exposed fill: All of the face of a fill slope resulting from development, from the toe to the top of the fill, whether the surface treatment is retaining wall, riprap, natural vegetation or other treatment.

Fast Track Permit: A Permit for Development that complies with Alternate Standards. The Fast Track Permit is issued in a shorter time period than the standard Development Permit due to Site planning approaches that limit water quality impacts.

Fill: Any material, structure, wall, rip-rap or revetment below the stated normal conservation pool elevations of the lakes.

Final Stabilization: All soil disturbing activities at the Site that have been completed and a uniform (e.g. unevenly distributed, without large bare areas) perennial vegetative cover with a density of 70 percent of the native background vegetative cover for the area has been established on all unpaved areas and areas not covered by permanent structures, or equivalent permanent stabilization measures, such as rip-rap, gabions, or geotextile fabric, have been employed.

Finish grade: The final grade of the site which conforms to the approved plan.

General Utility Permit: A Permit designed for utility construction in a public right-of-way by a Public Utility whereby the Public Utility complies with the Ordinance and the LCRA Technical Manual. The General Utility Permit covers all routine construction, maintenance and repair work anywhere within the jurisdictional area without having to obtain a Permit for each project.

Grade: The vertical location of the ground surface, or the degree of rise or descent of a slope.

Groundwater Conservation District: Means a groundwater conservation district as it is defined in Chapter 36, Texas Water Code, currently defining a “groundwater conservation district” as a district created under Section 52, Article III and Section 59, Article XVI Texas Constitution, that has the authority to regulate the spacing of water wells, the production from water wells, or both.

Impervious Cover: Impermeable surfaces, such as pavement, sidewalks or rooftops, that prevent the infiltration of water into the soil.

Infiltration: The passage or movement of water into the subsurface.

Innovative BMPs: Those practices designed by the Applicant’s engineer to meet or exceed LCRA’s performance standards but which are not described in LCRA’s Technical Manual.

Landowner: Any Person holding legal or equitable title to or having a fee simple ownership interest in land.

Land User: Any Person operating, leasing, renting or having made other arrangements with the Landowner by which the Landowner authorizes use of his or her land.

LCRA: Lower Colorado River Authority

LCRA General Counsel: The General Counsel of the LCRA or his/her designee.

LCRA General Manager: The General Manager of the LCRA or his/her designee.

Low Impact Development: Site and subdivision Development that incorporates design approaches that mimic the existing hydrologic features while employing localized Pollution prevention measures to manage hydrology and water quality.

Marina: Any structure, or combination of structures that is designed for the mooring of watercraft, including any marine fuel facility located on or over the surface of a lake.

Marina fuel facility: A facility located on or over the surface of the lake that provides fueling services for watercraft.

Master Plan: A conceptual plan of a multi-phased Development showing the order of Phased Development, environmental features (such as Creeks, tributaries, slopes, etc.), roads, and proposed location of water quality protection measures for the Development.

Mine: An excavation in the earth from which ores, coal, or other mineral substances are being or have been removed by digging or other mining methods. A Mine shall include an area of land or surface actively or previously mined for the production of dimension stone, crushed or broken stone, construction sand and gravel, clay, and/or industrial sand.

Multi-family development: Any building that contains three or more attached units designed for residential use.

Natural drainage: A stormwater runoff conveyance system not altered by manmade changes of the land's surface.

Natural state: The condition of the land existing prior to any development activities.

One-hundred year floodplain: The land adjacent to a waterway that has a one percent chance of being flooded in any given year.

One-year design storm: A rainfall event which has a volume of 1.93 inches and occurs over a 3-hour period.

Ordinance: Highland Lake Watershed Ordinance. This Ordinance is a merger and combination of amendments to the former Lake Travis Nonpoint Source Pollution Control Ordinance and the former Upper Highland Lakes Nonpoint Source Pollution Control Ordinance (the Ordinances). The Ordinances are combined and renamed the Highland Lakes Watershed Ordinance. The Lake Travis Nonpoint Source Pollution Control Ordinance and the Upper Highland Lakes Nonpoint Source Pollution Control Ordinance shall continue in effect until February 1, 2006, although the separate requirements of these former Ordinances are now combined in this Ordinance.

Ordinance Watershed Map: Map accompanying the LCRA Ordinance and LCRA Technical Manual that delineates the area subject to the Ordinance coverage.

Pit: An open Excavation not less than five (5) feet below the adjacent and natural ground level from which Aggregate has been or is being extracted for a Quarry/Mine activity.

Permit: An authorization issued by LCRA in accordance with the procedures prescribed in this Ordinance including an authorization to especially address BMPs for control of stormwater runoff pollution resulting from Development.

Permit Amendment: A revision to Development Permit issued by LCRA after an application for such amendment has been received and reviewed, and the expansion, Redevelopment, or modification plans have been found to be in compliance with this Ordinance and the LCRA Technical Manual. Permit Amendment procedures are described in the LCRA Technical Manual.

Permittee: A Landowner or Land User authorized to undertake land Development activities pursuant to a Permit granted according to the provisions of this Ordinance.

Person: Any individual, organization, trust, partnership, firm, association, public or private corporation, Political Subdivision or any other legal entity.

Phased Development: Development of land according to a Master Plan which occurs in stages and over an extended period of time.

Political Subdivision: A city, county, district or authority created under Article III, Section 52, or Article XVI, Section 59, of the Texas Constitution and any other political subdivision of the state.

Pollution: Alteration of the physical, thermal, chemical or biological quality of, or the contamination of, any water in the state that renders the water harmful, detrimental, or injurious to humans, animal life, Vegetation, property, or public health, safety, or welfare, or impairs the usefulness or the public enjoyment of the water for any lawful or reasonable purpose.

Quarry: A Site where aggregates are being or have been removed or extracted from the earth to form the pit, including the entire excavation, stripped areas, haulage ramps, the land immediately adjacent thereto upon which the plant processing the raw materials is located, exclusive of any land owned or leased by the responsible party not being currently used in the production of aggregates.

Quarry/Mine Exploration: Activities including but not limited to core drilling, testing, and sampling to determine Aggregate type and volume.

Quarry/Mine Operator: Any person, partnership, firm, or corporation engaged in and responsible for the physical operation and control of the extraction of Aggregate.

Quarry/Mine Owner: Any person, partnership, firm, or corporation having title, in whole or in part, to the land on which an Aggregate operation exists or has existed.

Quarry/Mine Permit: A Permit for quarrying and mining within the jurisdictional area specifically addressing Best Management Practices for control of Stormwater Runoff Pollution resulting from mines and quarry activities

Reclamation: The process of removing structures, equipment, re-grading and re-vegetating as necessary for restoration of land affected by quarrying/mining to protect water quality and maintain compliance with this Ordinance.

Redevelopment: Any rebuilding, renovation, replat of property, revisions, remodel, reconstruction of an Existing Development or redesign of an Existing Development occurring after February 1, 1990, in the Lake Travis Watershed in Travis County, or March 19, 1992 in Llano County or Burnet in the Colorado River Watershed as reflected in Attachment 2, and which does not cumulatively increase Impervious Cover by 10,000 square feet or more.

Riparian corridor: The ecological areas within and adjacent to the floodplain that can be comprised of the following species:

Pecan, American elm, Arizona Walnut, Bald Cypress, Black Walnut, Bur Oak, Cedar Elm, Little Walnut, Green Ash, Texas Sugarberry, American Sycamore, Eastern Cottonwood and Black Willow, Live Oak.

Sedimentation: Deposition of detached soil particles.

Sheet flow: Water or stormwater runoff flowing in a thin layer over the ground surfaces.

Shoreline Stabilization: The construction of structures such as revetment, rip-rap, retaining walls, bulkheads as defined in the LCRA Technical Manual and any approved innovative practices constructed to stabilize the shoreline of a body of water.

Single-family Subdivision Development: A Development subdivision consisting of two or more Single-family Residences.

Single-family Residence: One- and two-family dwelling units designed for occupancy by one or two families as a residence.

Site: The property boundaries encompassing a Development, Quarry, or Mine and the area described within a Permit application.

Slope: A measure of the change in vertical elevation of a site as compared to the horizontal distance between two stations. Slope can be defined in three manners, as presented below. The slope is to be based on the post-development condition of the development site.

Slope (expressed as percent) - The ratio of the vertical change in elevation to the horizontal distance between the two stations. As an example, if the elevation change is 5 feet over a horizontal distance of 100 feet, the slope is $(5/100)*100 = 5\%$.

Slope (expressed as a ratio) - The ratio of horizontal distance to vertical elevation change between two stations. As an example, if over a horizontal distance of 100 feet the elevation changes by 5 feet, the slope is $(100:5) = 20:1$.

Slope (expressed in degrees) - the arctangent of the vertical elevation change divided by the horizontal distance between two stations. As an example, if the elevation change is 5 feet over a horizontal distance of 100 feet, the slope is the arctangent of $(5/100) = 2.9$ degrees.

SLOPE TABLE		
Percent	Ratio	Degrees
1%	100:1	0.6
5%	20:1	2.9
10%	10:1	5.7
15%	6.7:1	8.5
20%	5:1	11.3
25%	4:1	14.0
50%	2:1	26.6
100%	1:1	45.0

Spring: A point or zone of natural groundwater discharge having measurable flow and/or a pool and characterized by the presence of a mesic plant community adapted to the moist conditions of the site.

Stormwater Runoff: The portion of the precipitation on the land that flows over the surface and may reach Creeks, rivers, and/or lakes.

Stormwater Runoff Pollution: Pollution that is caused by or attributable to diffuse sources. Typically, Stormwater Runoff Pollution results from land runoff, precipitation, atmospheric disposition or percolation.

Subdivision plan: Preliminary plans submitted for the review of lot and street and drainage design for the division of any tract of land into two or more parcels, including re-subdivisions.

Terrace: A level step constructed sometimes in combination with a channel across the face of a slope parallel to the contours to control erosion by diverting or storing surface runoff instead of permitting it to flow uninterrupted down a slope.

Texas Commission on Environmental Quality Stormwater Pollution Prevention Plan (TCEQ SWPPP): The plan defined in the Construction Stormwater General Permit to manage construction activities to minimize the discharge of sediment and pollutants during construction of a Development.

Two-year design storm: A rainfall event which has a volume of 2.6 inches and occurs over a 3-hour period.

Utility: A Person that owns or operates, for compensation, facilities or equipment for producing, generating, transmitting, selling or furnishing services including electricity, petroleum products, water, natural gas, sewer service, cable or telephone services.

Vegetation: Plant life or total plant cover on a land surface.

Bibliography

CASQA, 2004, *Stormwater Best Management Practice Handbook: New Development and Redevelopment*, California Stormwater Quality Association, www.bmphandbooks.com

Center for Watershed Protection, 2000, *2000 Maryland Stormwater Design Manual, Volumes I and II*

Center for Watershed Protection, 2000, *The Importance of Imperviousness, The Practice of Watershed Protection*

City of Austin, 1990, *The First Flush of Runoff and Its Effects on Control Structure Design*, Drainage Utility Department, Environmental Resource Management Division.

City of Austin, 1997, *Drainage Criteria Manual*, Drainage Utility Department, Austin, Texas

City of Austin, 1997, *Environmental Criteria Manual*, Drainage Utility Department, Austin, Texas

City of Austin/Texas Cooperative Extension, 2005, *Native and Adapted Landscape Plants, an Earth-wise Guide for Central Texas*

City of Austin, 2006, *Stormwater Runoff Quality and Quantity from Small Watersheds in Austin, Texas*, Watershed Protection Department, Austin, Texas

Environmental Protection Agency, 1991, *Handbook of Suggested Practices for the Design and Installation of Ground-Water Monitoring Wells*.

Environmental Protection Agency, *Spill Prevention Control, Containment, and Countermeasures*

Fowler, 2005, *Construction Site Evaluation Worksheet for SWP3 Design*, Travis County TNR

Fowler, 2004, *Instructions for Preparing and Implementing Stormwater Pollution Prevention Plans (SWP3s) for Travis County Operated Construction Activities*, draft, Travis County TNR

James Miertschin and Associates, Inc., 2005 and 2007, *Studies for NPS Technical Manual Revisions*, technical memorandums to LCRA

Livingston, *Lessons Learned About Successfully Using Infiltration Practices*, Florida Department of Environmental Protection.

Lower Colorado River Authority, 1998, *Nonpoint Source Pollution Control Technical Manual, 3rd Edition*, Austin, Texas

Lower Colorado River Authority, 2005, *Texas Hill Country Landscape Option*, Austin, Texas

Lower Colorado River Authority, 2007, *Conservation and Landscape Guidelines (For Use in Ordinances or Deed Restrictions)*, Austin, Texas

Lower Colorado River Authority, 2007, *LCRA Soil Depth and Soil Amendment Specifications Background*, Austin, Texas

McBride, Maeve and Booth, Derek, 2005, *Urban Impacts on Physical Stream Condition: Effects of Spatial Scale, Connectivity, and Longitudinal Trends*, Journal of the American Water Resources Association, June.

Middleton and Barrett, 2006, *Water Quality Performance of a Batch Type Stormwater Detention Basin*, Austin, Texas

Mine Safety and Health Administration, *Hazard Communications Plan*

Naismith Engineering, Inc., 2005, *Regional Water Quality Protection Plan for the Barton Springs Segment of the Edwards Aquifer and its Contributing Zone*

North Carolina Dept. of Environment, Health and Natural Resources et al, 1993, *Erosion and Sediment Control Planning and Design Manual*, Division of Land Resources, Land Quality Section.

North Central Texas Council of Governments, 1993, *Storm Water Quality Best Management Practices for Residential and Commercial Land Uses*, Arlington, TX.

North Central Texas Council of Governments, 1993b, *Storm Water Quality Best Management Practices for Construction Activities*, Arlington, TX.

Northcutt, P., 1993, *A Practical Guide to the Establishment of Vegetative Cover on Highway Rights-of-Way*, Texas Dept. of Transportation, Construction and Maintenance Division, Vegetation Management Section.

Raymond Chan & Associates, et al., 1997, *Regulatory Approaches for Managing Stream Erosion*, report to the City of Austin Drainage Utility Department.

Raymond Chan & Associates, 2005, *Proposed Highland Lakes Watershed Ordinance, Erosion and Sediment Control Comments and Observations*, letter to LCRA dated October 13, 2005.

Prince George's County, Maryland, 1999, *Low Impact Development Design Strategies*

Puget Sound Action Team, 2005, *Low Impact Development, Technical Guidance for Puget Sound*

Schueler, T.R., 1987, *Controlling Urban Runoff: A Practical Manual for Planning and Designing Urban BMPs*, Department of Environmental Programs, Metropolitan Washington Council of Governments, Washington, DC.

Tetra Tech, Inc., 2005, *Kentucky Erosion Prevention and Sediment Control Field Guide*

Texas Commission on Environmental Quality, 2005, *Optional Enhanced Measures for the Protection of Water Quality in the Edwards Aquifer*

Texas Commission on Environmental Quality, 2005, *Complying with the Edwards Aquifer Rules: Technical Guidance on Best Management Practices, RG-348*

Texas Commission on Environmental Quality, Revised 2004, *Landfill Site Selection Technical Guidance Number 2.*

Texas Commission on Environmental Quality, *Rule Interpretation Summary Form 330-4.001.*

Texas Commission on Environmental Quality, 2003, *Texas Pollution Discharge Elimination System General Permit for Construction Storm Water Runoff, TXR150000*

Texas Commission on Environmental Quality, 2006, *Texas Pollution Discharge Elimination System Industrial Sector Permit*

Texas Commission on Environmental Quality, *Multi-Sector General Stormwater Permit*

Texas Department of Licensing and Regulations, *Water Well Drillers Rules.*

Texas Department of Transportation, 1993, *Storm Water Management Guidelines for Construction Activities*, Division of Bridges and Structures, Hydraulics Section, Austin, TX

Texas Parks and Wildlife Department, *Marl, Sand, and Gravel Mining in Public Waters of the State*

Texas Water Development Board, 1997, *Texas Guide to Rainwater Harvesting, Second Edition*, in cooperation with Center for Maximum Potential Building Systems, Austin, TX

United States Department of Agriculture, Soil Conservation Service, June, 1986, *Urban Hydrology for Small Watersheds (Technical Release 55)*

United States Fish and Wildlife Service, 2000, *Water Quality Protection Measures*

United States Fish and Wildlife Service, 2002, *Water Quality Protection Measures*, draft report

Urbonas, B.R., et al., 1992, *Urban Storm Drainage Criteria Manual, Volume 3 – Best Management Practices, Stormwater Quality*, Urban Drainage and Flood Control District, Denver, CO.

Vickers, February 2007, *Are Water Managers Becoming Lawn Irrigation Managers*, AWWA Journal.

Virginia Department of Conservation and Recreation, 1992, *Virginia Erosion and Sediment Control Handbook*, Third Edition, 1992, Division of Soil and Water Conservation, Richmond, VA

Wilding, October 2006, *Pre-filed Testimony of Dr. Larry Wilding, Application of Lazy Nine Municipal Utility District and Forest City Sweetwater Limited Partnership for Proposed Permit WQ0014629001*, Austin, Texas

Woodruff, C.M. et al, 1993, *Soils, Landforms, Hydrologic Processes, and Land-Use Issues- Glen Rose Limestone Terrains, Barton Creek Watershed, Travis County, Texas*

The Technical Manual is currently undergoing revisions to address Ordinance revisions adopted on 2/19/2014.

The revised Ordinance and updated application forms, fee schedule and other documents found in the Appendix can be accessed on our website using the following links:

Appendix 1.1 LCRA Highland Lakes Watershed Ordinance (rev. 2/19/2014)

<http://www.lcra.org/water/quality/watershed-management-ordinance/Documents/HighlandLakesWatershedOrdinance.pdf>

Appendix 1.2 Development and Quarry/Mine Permit Application Form - see page 2 of the link below:

http://www.lcra.org/water/quality/watershed-management-ordinance/Documents/hlwo_developer_application_packet.pdf

Appendix 1.3 Fee Schedule

<http://www.lcra.org/water/quality/watershed-management-ordinance/Documents/HLWO-Fee-Schedule-Feb-2014.pdf>

Appendix 1.4 "Notification Of No Permit Required" Form - see page 10 of the link below:

http://www.lcra.org/water/quality/watershed-management-ordinance/Documents/hlwo_developer_application_packet.pdf

Appendix 1.4.1 Dredge and Fill Standards Checklist -

http://www.lcra.org/water/quality/watershed-management-ordinance/Documents/Dredge_and_FillChkList.pdf

Appendix 1.5 Development Permit Submittal Requirements

see pages 4-6 of the link below:

http://www.lcra.org/water/quality/watershed-management-ordinance/Documents/hlwo_developer_application_packet.pdf

Master Plan Submittal Requirements

Provide two (2) copies of documents listed below (except the application form). Electronic copies of reports and documents may be required upon request.

1. Completed application form (Appendix 1.2) and fee per Appendix 1.3.
2. Detailed location map.
3. List of property owners adjacent to the site. The names of the landowners shall be determined by the applicant based upon the records from the appropriate County Tax Appraisal District.
4. Engineering Report – report shall discuss site characteristics and water quality management strategies and include the following information:
 - description of site and of proposed development
 - location and type of soils. This information can be obtained from the County Soil Survey.
 - vegetative cover map (aerial photograph) including tree and ground cover.
 - engineer's seal, signature and statement certifying that the plan is complete and in compliance with this ordinance.
 - data and calculations for water quality BMPs and associated drainage facilities, including drainage area, impervious cover area, time of concentration, runoff coefficients and discharge for 1 year and 25 year storm events, volume calculations for all ponds, floodplain calculations for fully developed conditions or FEMA floodplain delineation when used to define a buffer zone.
 - description of the BMPs to be implemented to achieve the performance standards for Water Quality Management.
 - discussion of BMP maintenance requirements and entity responsible for BMP maintenance
 - preliminary phasing schedule.
5. Water Quality Management Plan – The plan shall include sheet(s) at an appropriate scale¹ and in sufficient detail to ensure the feasibility of the proposed water quality management plan. Required information on the plan includes the following, however additional information may be required.
 - existing topography
 - drainage patterns including drainage area maps for any offsite contributing areas (may be larger scale as needed)
 - delineation of floodplain, buffer zones and notes restricting activities within same
 - site layout showing all proposed improvements and structures
 - location and schematic of the Best Management Practices (BMPs) and BMP easements

¹ Suggested minimum scale of 1"=100' for tracts under 100 acres, 1" = 200' for tracts 100 to 250 acres 1" = 400' for tracts 250 to 400 acres, and 1" = 1000' for larger tracts. Suggested contour line interval of 2' intervals for projects up to 400 acres or 5' intervals for projects

greater than 400 acres. Offsite areas can utilize USGS topographic maps at a scale of 1"=2000' to delineate drainage area boundaries..

6. Slope maps, at the same scale as the water quality management plan, depicting slope categories of 0-10%, 10-20%, and over 20%. The slope categories shall be determined by measuring between contour lines. For 2 foot contours the average of 5 contour intervals may be used and for 5' contours the average of 4 will be accepted. Master plan applications submitted under ALTERNATE PERFORMANCE STANDARDS FOR SINGLE FAMILY SUBDIVISIONS and COMMERCIAL DEVELOPMENT will not require a slope map.
7. Contact the Water Surface and Shoreline Management office to determine whether the project will require permits for Marina and On-site Sewage Facility permitting/licensing.
8. Any other information deemed necessary by LCRA to demonstrate compliance with the ordinance.

BMP Maintenance Permit Submittal Requirements

1. Completed BMP Maintenance Permit Application and fee per Appendix 1.7.1 and Appendix 1.3 respectively..
2. Specifications for routine and non-routine maintenance activities to be performed;
3. A schedule for maintenance activities;
4. Provisions for access to the tract by LCRA or other designated inspectors;
5. Name, qualifications and contact information for the person(s) responsible for maintaining the BMP(s). Articles of Association, if a Maintenance Association will be responsible for the BMPs within the development.
6. Record (“as-built) Copy of Approved Water Quality Management Plan.

BMP Maintenance Permit Application

Application # _____

LCRA HIGHLAND LAKES WATERSHED ORDINANCE BMP MAINTENANCE PERMIT APPLICATION

APPLICANT NAME: _____

MAILING ADDRESS: _____

CITY/STATE/ZIP: _____

PHONE: Daytime: () _____ Fax: () _____

OWNER'S NAME: _____

CORPORATE NAME (if applicable): _____

MAILING ADDRESS: _____

CITY/STATE/ZIP: _____

PHONE: Daytime: () _____ Fax: () _____

PROJECT NAME: _____

LCRA DEVELOPMENT PERMIT NUMBER: _____

NUMBER OF ACRES IN PROJECT: _____

ADDRESS/LOCATION OF PROPERTY: _____

COUNTY: _____ LAKE: _____

CERTIFICATION

I (we), the undersigned, do hereby certify that to the best of our knowledge this application correct, complete and complies with the LCRA Highland Lakes Watershed Ordinance. By submitting an application, the applicant and/or owner is authorizing LCRA to enter the site to obtain information required for review of this permit application and to inspect BMPs located within the property.

Applicant

Date

Property Owner

Date

Water Quality Basin BMP Maintenance Checklist Example

Structural BMP Annual Maintenance Inspection Checklist

Project/Permit # : _____
Location/Address: _____
Community/Lake: _____
Facility Type(s): _____
Inspection Date: _____ Time: _____ Inspector: _____

STRUCTURAL INTEGRITY

Yes No N/A

Does the facility show signs of settling, cracking, bulging, misalignment, or other structural deterioration?

Yes No N/A

Do embankments, emergency spillways, side slopes, or inlet/outlet structures show signs of excessive erosion?

Yes No N/A

Is the outlet pipe damaged, blocked by debris or otherwise not functioning properly?

Yes No N/A

Do storage and inlet areas show erosion, low spots, or lack of stabilization?

Yes No N/A

Are trees or saplings adjacent to concrete walls?

Yes No N/A

Are trees or saplings present on the embankment? Animal burrows present?

Yes No N/A

Are grassed areas less than 18 inches in height?

Yes No N/A

Are leaves or clippings accumulating?

WORKING CONDITIONS

Yes No N/A

Does the depth of sediment exceed 1 inch in a sand filtration pond, 6 inches in an extended detention pond, or suggest a loss of volume?

Yes No N/A

Does sediment accumulation exceed 25% of the drainage opening area?

Yes No N/A

Is there standing water in the wrong places?

Yes No N/A

Is there an accumulation of debris and trash?

OTHER INSPECTION ITEMS

Yes No N/A

Is there evidence of encroachments on BMP and/or maintenance access strip, or improper use of impoundment areas?

Yes No N/A

Is there excessive algae growth, or has one type of vegetation taken over the facility?

Yes No N/A

Is there evidence of oil, grease, or other fluids and chemicals entering the facility?

Yes No N/A

Do noxious odors, insects, or weeds dominate the local environment?

Yes No N/A

Has rainfall occurred in the 72 hours prior to inspection?

Yes No N/A

Are pervious pavement surfaces and infiltration devices properly draining?

Yes No N/A

In bioretention, is there evidence of erosion, does mulch cover the area, are specified type and numbers of plants still in place, or is there evidence of plant stress from water conditions?

OTHER OBSERVATIONS

Vegetative BMP Maintenance Inspection Checklist

Project/Permit # : _____
Location/Address: _____
Community/Lake: _____
Facility Type(s): _____
Inspection Date: _____ Time: _____ Inspector: _____

STRUCTURAL INTEGRITY

Yes No N/A

Does vegetation cover at least 95% of the engineered filter strip and/or does vegetation cover at least 75% of the natural vegetative filter strips?

Yes No N/A

Does the depth of sediment exceed 3 inches in vegetated swales?

Yes No N/A

Can existing silt fences/rock berms be removed?

Yes No N/A

Are grassed areas less than 18 inches in height?

Yes No N/A

Are leaves or clippings accumulating?

WORKING CONDITIONS

Yes No N/A

Is there standing water in the wrong places?

Yes No N/A

Is there an accumulation of debris and trash?

OTHER INSPECTION ITEMS

Yes No N/A

Is there excessive erosion on the project site?

Yes No N/A

Is there evidence of encroachments on BMP and/or maintenance access strip, or improper use of impoundment areas?

Yes No N/A

Do bare spots larger than 25 square feet exist in vegetated filter strips and swales?

Yes No N/A

Is there evidence of oil, grease, or other fluids and chemicals entering the facility?

Yes No N/A

Do noxious odors, insects, or weeds dominate the local environment?

Yes No N/A

Has rainfall occurred in the 72 hours prior to inspection?

OTHER OBSERVATIONS

Utility General Permit Submittal Requirements

Initial Submittal:

1. Application form including name, address and phone numbers of persons responsible for the supervising or managing the routine activities provided for under the Utility Permit.
2. Map showing the planned utility extensions covered by this permit.
3. Description of routine construction and maintenance activities proposed for coverage under the permit.

For each construction project, submit the following information:

1. Cover Letter stating project location, project description and schedule;
2. Construction plans for the utility improvements;
3. Erosion and Sedimentation Control (ESC) Plan – plan sheets(s) at an appropriate scale¹ showing the following information.
 - existing topography
 - proposed grading and drainage patterns
 - all proposed improvements and structures,
 - limits of construction line,
 - location of all access roads, haul roads, equipment storage areas, spoil and topsoil stockpile areas.
 - location and schematic of temporary and permanent ESC,
 - detailed sequence of construction indicating items to be constructed in each construction stage and ESC modifications to be implemented as construction progresses.
 - details and specifications for ESC, and locations of controls.
 - location and specifications for all structural stabilization, including stabilization of cut and fill areas.
 - restoration plans for all disturbed areas on the site that include seed, sod and mulch type and rate of application; application technique; watering and fertilization schedule; criteria for acceptance of site stabilization.

¹Suggested minimum scale of 1"=50' with minimum 5' contour intervals. For large projects, include a sheet index/overall layout sheet showing the entire project extent.

Preliminary Plat Review Submittal Checklist

1. Detailed location map.
2. List of property owners adjacent to the site. The names of the property owners shall be determined by the applicant based upon the records from the appropriate County Tax Appraisal District.
3. Engineering Report – report shall discuss site characteristics and water quality management strategies and include the following information:
 - description of site and of proposed development
 - location and type of soils. This information can be obtained from the County Soil Survey.
 - vegetative cover map (aerial photo) including tree and ground cover. If vegetative BMPs are proposed, more specific information may be required.
 - engineer's seal, signature and statement certifying that the plan is complete and in compliance with this ordinance.
 - data and calculations for water quality BMPs and associated drainage facilities, including drainage area, impervious cover area, time of concentration, runoff coefficients and discharge for 1 year and 25 year storm events (used to size vegetative filter strip width and determine flow splitter elevation), volume calculations for all ponds, floodplain calculations for fully developed conditions or FEMA floodplain delineation when used to define a buffer zone.
 - description of the BMPs to be implemented to achieve the performance standards for Water Quality Management.
 - discussion of BMP maintenance requirements and entity responsible for BMP maintenance
 - preliminary phasing schedule.
4. Water Quality Management Plan – The plan shall include sheet(s) at an appropriate scale¹ and in sufficient detail to ensure the feasibility of the proposed Water Quality Management Plan. Required information on the plan includes the following, however additional information may be required.
 - existing topography
 - proposed grading and drainage patterns including drainage area maps for any offsite contributing areas (may be larger scale as needed)
 - delineation of floodplain, buffer zones and notes restricting activities within same
 - site layout showing all proposed improvements and structures
 - location and schematic of the Best Management Practices (BMPs) and BMP easements

¹ Suggested minimum scale of 1"=100' for tracts under 100 acres, 1" = 200' for tracts 100 to 250 acres 1" = 400' for tracts 250 to 400 acres, and 1" = 1000' for larger tracts. Suggested contour line interval of 2' intervals for projects up to 400 acres or 5' intervals for projects greater than 400 acres. Offsite areas can utilize USGS topographic maps at a scale of 1"= 2000' to delineate drainage area boundaries.

5. Slope maps, at the same scale as the topographic map, depicting slope categories of 0-10%, 10-20%, and over 20%. The slope categories shall be determined by measuring between contour lines. For 2 foot contours the average of 5 contour intervals may be used and for 5' contours the average of 4 will be accepted. Preliminary plats submitted under ALTERNATE PERFORMANCE STANDARDS FOR SINGLE FAMILY SUBDIVISIONS and COMMERCIAL DEVELOPMENT will not require slope maps.
7. Contact the Water Surface and Shoreline Management office to determine whether the project will require permits for Marina and On-site Sewage Facility permitting/licensing.
8. Any other information deemed necessary by LCRA to demonstrate compliance with the ordinance.

Final Plat Review Submittal Checklist

1. Detailed location map.
2. Engineering Report – report shall discuss site characteristics and water quality management strategies and include the following information:
 - description of site and of proposed development
 - location and type of soils. This information can be obtained from the County Soil Survey.
 - vegetative cover map (aerial photograph) including tree and ground cover. If vegetative BMPs are proposed, more specific information may be required.
 - engineer's seal, signature and statement certifying that the plan is complete and in compliance with this ordinance.
 - data and calculations for BMPs and associated drainage facilities, including drainage area, impervious cover area, time of concentration, runoff coefficients and discharge for 1 year and 25 year storm events, conveyance capacity calculations, volume calculations for all ponds, floodplain calculations for fully developed conditions..
 - description and schematic of the BMPs to be implemented to achieve the performance standards for Water Quality Management.
 - discussion of BMP maintenance requirements and entity responsible for BMP maintenance
3. Plat – Show the following items on the plat.
 - delineation of floodplain, buffer zones and notes restricting activities within same
 - site layout showing all proposed improvements and structures
 - easements for Best Management Practices (BMPs)
 - Plat notes regarding BMP easement restrictions, permitting requirements, etc.
4. Slope maps, at the same scale as the topographic map, depicting slope categories of 0-10%, 10-20%, and over 20%. The slope categories shall be determined by measuring between contour lines. For 2 foot contours the average of 5 contour intervals may be used and for 5' contours the average of 4 will be accepted.
5. Contact the Water Surface and Shoreline Management office to determine the need for Marina and On-site Sewage Facility permitting/licensing.

Note: All of the above items may not be applicable to every situation. Completion of the application checklist will be considered on a case-by-case basis by LCRA staff.

Plat Notes

Waterway Buffer Zone Plat Note:

The Waterway Buffer Zone Easement is for the protection of the environment by improving the quality of stormwater runoff from developed lands. The native land or management practices within the Easement are to help maintain clean water in creeks, rivers and lakes. No structure or improvements, other than native plant enhancement or maintenance of the area in accordance with LCRA rules, may be placed or performed within the Easement without specific prior authorization and approval in writing from the LCRA, its successors or assigns, or other governmental entity with authority to permit such improvement for the protection of the environment. The Easement shall be maintained by each lot owner by preserving and restoring native vegetation. The Easement may not be amended except by express written agreement of the LCRA, its successors or assigns, or other governmental entity with property authority.

Lower Colorado River Authority

Date

Permanent Water Quality BMP Easement Plat Note:

The Permanent Water Quality Best Management Practice (BMP) Easement is for the purpose of protecting the environment by improving the quality of stormwater runoff from developed lands. No structure or other improvement may be constructed or maintained within a Water Quality BMP Easement area unless specifically authorized and approved in writing in advance by the Lower Colorado River Authority (LCRA).

The Water Quality BMP Easement may be enforced by the Lower Colorado River Authority or any other governmental entity with the authority to protect the environment for the benefit of the public, by injunction or other action in a court of appropriate jurisdiction.

Lower Colorado River Authority

Date

Permit Plat Note:

All property herein is subject to the Lower Colorado River Authority's Highland Lakes Watershed Ordinance. Written notification and/or permits are required prior to commencing any development activities. Contact LCRA Watershed Management at 1-800-776-5272, extension 2324 for more information.

The Technical Manual is currently undergoing revisions to address Ordinance revisions adopted on 2/19/2014.

The revised Ordinance and updated application forms, fee schedule and other documents found in the Appendix can be accessed on our website using the following links:

Appendix 1.12 Letter of Credit Example Forms see page 8 of the link below:

http://www.lcra.org/water/quality/watershed-management-ordinance/Documents/hlwo_developer_application_packet.pdf

Appendix 1.13 Newspaper Notice Example – this item has been deleted

Project Sign Example

NOTICE

Project Name: _____

Applicant Name & Address: _____

Site Location: _____

Project Description: _____

An application has been made to LCRA for approval of the following:

Development Permit

Master Plan

Quarry/Mine Certification

Quarry/Mine Permit

at this location. LCRA has determined that the application is administratively complete. Any person may comment on the application. Written comments should be either mailed or delivered to the LCRA no later than 15 days from the date on this notice in order to be considered in the review of the application:

Mail:
LCRA – Watershed Management
Mail Stop L-421
P.O. Box 220
Austin, TX 78767

Delivered:
LCRA – Watershed Management
3700 Lake Austin Blvd.
Austin, TX 78703
Mail Stop L-421

Additional information regarding this application may be obtained by contacting the LCRA Watershed Management Office at 512-473-3200, ext. 2324.

The Technical Manual is currently undergoing revisions to address Ordinance revisions adopted on 2/19/2014.

The revised Ordinance and updated application forms, fee schedule and other documents found in the Appendix can be accessed on our website using the following links:

1.14.1 & 1.14.2 Mailed Notice Example- Development Permit or Master Plan

- see page 9 of the link below:

http://www.lcra.org/water/quality/watershed-management-ordinance/Documents/hlwo_developer_application_packet.pdf

LCRA DEVELOPMENT PERMIT INSPECTION PROCEDURES

Section 1. Temporary Erosion and Sedimentation Controls

All erosion and sedimentation controls (ESC) are to be installed and maintained per the approved plans and LCRA Water Quality Management Technical Manual (Technical Manual). Construction may not begin until compliance is certified by the LCRA Inspector at the pre-construction meeting.

LCRA Inspector: _____ Phone: _____ Mobile: _____

- Follow the sequence of construction as per the approved plans.
- ESC should be phased to be effective at all stages of construction and additional controls may be necessary.
- The LCRA Inspector must approve changes to the ESC plan. Minor adjustments are commonly approved without permit or plan amendments.
- Projects must comply continuously with ESC measures and all related requirements during construction.
- Inspect ESC weekly and after rainfall of 0.5” or greater and promptly make repairs and remove sediment to restore proper ESC function.
- Observe the limits of construction at all times. Additional financial security requirements may result from failure to observe limits of construction.
- If ponds are proposed for the projects, rough-cut ponds may be used as temporary sediment traps. Any impoundment must be constructed with properly compacted embankments and a stabilized overflow. See Chapter 3 of the LCRA Water Quality Management Technical Guidance Manual for additional information.
- Keep all adjacent streets clean of sediment and debris and minimize tracking in and out of the project when muddy conditions exist. If tracking occurs, take corrective action immediately.
- Keep the site area clean to prevent trash from leaving the worksite. Use secured trash receptacles or constructed bins for waste materials and trash. Provide and use proper sanitary facilities.
- Construction adjacent or across creeks must comply with special requirements for construction in creeks. Remove all equipment, materials, and excavated material to a secure location outside the creek channel and suspend further construction in

creek if rainfall threatens. Place excavated material in an area where it cannot re-enter the waterway or in an area protected with appropriate erosion controls to prevent runoff from the excavated material from re-entering the waterway. Any discharges of water containing sediment must be discharged to an approved sediment trapping device – silt fence or rock berms catchments, settling tanks or pits are recommended. A de-watering plan may be required.

- Site Stabilization should start as soon as possible and is required for all areas disturbed by the construction, per the seed specifications on the approved plans.
- The LCRA Inspector may issue a Stop Work Order (Red Tag) for noncompliance. The permit may also be revoked for noncompliance with these requirements.

Section 2. Spoil/Fill Disposal

Any spoil/fill material disposed of off-site must be disposed of at a permitted site or a site with verified exempt status.

- Please notify the LCRA Inspector at least 48 hours prior to disposal and keep a copy of the disposal site permit and receipt for the off site disposal at the job site.
- All on-site temporary and permanent fill areas must comply with the location, depth, and limits on the approved plan. Temporary seeding of long term stockpiles is recommended. All fill areas must be restored with vegetation prior to completion of the project.

Section 3. Violation Procedures (Guidelines)

Priority Violations:

- No permit for development activity.
- Failure to install ESC prior to commencing development.
- Failure to notify LCRA prior to commencing development.
- Clearing, grading, or filling beyond what is delineated on the approved plans, which results in damage to creeks, natural areas, or immediate water quality degradation.
- Occupancy of facilities prior to final inspection and release from the LCRA Inspector.
- Any discharge of sediment or sediment laden waters to a waterway or off the site. (e.g. discharging silted water from a site excavation and/or bore pit directly into a waterway).

- Repeated Routine Violations. Three or more consecutive inspections with routine violations shall constitute a Priority Violation.

Routine Violations:

- Failure to perform maintenance and/or repair temporary ESC after disturbance or rainfall events.
- Improper installation of ESC.
- Failure to follow sequence of construction.
- Failure to make revisions to temporary ESC as directed by the inspector.
- Tracking of soil, base materials, gravel, or paving materials onto roadway.

Priority Violation Procedure (Red Tag):

- Immediate Stop Work Order (Red Tag). After the project is brought into compliance, contact the LCRA inspector for a re-inspection.
- Failure to bring the project into compliance within 10 days can result in permit revocation and use of the applicant's financial security to stabilize the site. Penalties may be assessed for failure to comply with Ordinance provisions, ESC requirements and/or permit conditions.

Any Person violating provisions of this Ordinance shall be subject to a civil penalty of not more than \$5,000 for each violation. Each calendar day a violation exists shall constitute a separate violation (LCRA Highland Lakes Watershed Ordinance Section 9(f)).

Routine Violation Procedures:

1. Verbal and/or Written Notification of Corrective Action Required (Violation must be corrected within 5 working days)
2. "Red Tag" (see above procedure)

Section 4. Water Quality Management Best Management Practices

If a development permit includes construction of permanent Water Quality (WQ) Management BMPs, additional inspections are required. These inspections will verify the proper installation of underdrains, liners, filter media and other critical components. The LCRA inspector will review which BMP elements require additional inspections at the pre-construction meeting. After assembly/construction, but prior to covering these components, the contractor/owner shall call the LCRA Inspector for an inspection with a minimum notice of two (2) working days.

- Changes to the site layout and or permanent WQ Management BMPs will require a permit amendment prepared by the engineer of record.
- The LCRA Inspector may require the contractor/owner to uncover and allow viewing of any components not seen during construction.
- The Applicant’s Engineer must issue a written concurrence letter certifying that the permanent BMPS and associated drainage facilities are built as per the approved plan.
- The permanent BMPs must be complete and functional and a BMP Maintenance Permit must be approved prior to release of financial security for ESC.
- A final BMP inspection will also be made upon completion of the BMPs in conjunction with the Final Inspection for Site Stabilization.

Section 5. Final Inspection Release

Upon completion of the site work and when site stabilization has been achieved, the Applicant’s Engineer is required to submit a Concurrence Letter to the LCRA Watershed Management Office.

- Upon its receipt, the LCRA Inspector will conduct a “final inspection” of the site within 5 working days.
- If all requirements of the permit and approved plans are met (all structures, grading, and drainage facilities complete, all areas of the site stabilized with permanent vegetation or other approved means), the financial security for erosion/sedimentation controls will be released.
- The site will remain subject to the permit conditions and any required maintenance permit/agreements.

Section 6. Site Stabilization

Site Stabilization should start as soon as possible, shall be accomplished in phases if determined as a permit condition, and is required for all areas disturbed by the construction, per the revegetation plan indicated on the approved plans.

Annual grasses such as rye-grass will not be accepted as permanent re-vegetation.

- The project is not complete and the Erosion and Sedimentation Control Financial Security will not be released until permanent vegetation meets 70% coverage of 1½” tall grass with no bare areas exceeding 16ft², and all temporary ESC and accumulated sediment removed at the direction of the LCRA Inspector.
- Critical areas, including creek crossings, slopes, stormwater discharge points must be completely stabilized per approved plans.

- The LCRA Inspector is authorized to require additional stabilization measures as needed to prevent sediment discharge from the site or into receiving water bodies.

Example Alternate Standards – Single Family Development

- Project: Fifty (50) acre single family development in the Highland Lakes Ordinance jurisdiction,
- Lot Yield: The developer desires an average of two lots per acre,
- Topography: Slopes vary from 2 to 15% within the 50 acre tract, two distinct drainage areas, and
- Soils: Brackett and Tarrant soils as commonly found in the region.

To begin the process, buffer zones are delineated, a conceptual design is prepared and a pre-development meeting is held. Since the project strives to meet the alternate standards requirement, the development density must be reduced to a total effective impervious cover less than 15%. Then, the individual development areas (separate drainage areas) as noted in the Highland Lakes Watershed Ordinance are evaluated. In this example project, two drainage areas discharge from the site, thus, impervious cover from each drainage area must be less than 20% and total development impervious cover less than 15%. The designer used Table 2-4 in the Technical Manual to compute the project impervious cover. The first conceptual plan revealed impervious cover equal to 23 percent in one of the drainage areas and total impervious cover of 17% within the project boundary. To reduce the impervious cover to 20% in the drainage area to comply with alternate standards, the land planner reduced the street widths from 30 feet to 28 feet. In addition, the driveways for the single family homes will be constructed with porous pavement. The driveways will receive a 90% impervious cover reduction credit. With these changes, the drainage area impervious cover is now less than 20% and the total project impervious cover is less than 15%. The street plan also includes ribbon curb and roadside swales which promotes filtering and infiltration of runoff from all streets. Roadside swales discharge to the buffer zone in a sheet flow manner.

The development must prepare a detailed sediment control plan to minimize disturbance of soil, retain soil in construction areas, and rapidly vegetate the bare areas. Also, water quality education materials will be provided to all residents and annual education events hosted by LCRA will take place in the neighborhood. No maintenance permit is required since structural water quality basins are not part of the development. In addition, the project qualified for reduced permit fees and expedited permitting due to compliance with the Alternate Standards.

2.1.1 Example Alternate Standards – 1/5th acre lot using stormwater credits to gain alternate standards compliance

Below, a single-family development option is presented that maximizes the use of existing soils and native vegetation and combines stormwater credits with sound hydrologic design to protect water quality and avoid the cost and perpetual maintenance of structural water quality controls. The most important aspect of sound hydrologic design is configuring the development to work with the existing topography and vegetation. Whenever possible, roads should be located along ridgelines so runoff can sheet flow from the road and out of the right-of-way. This avoids roadside ditches that concentrate runoff, and then prove challenging to stabilize due to the steep terrain found in many developments. In addition, curb and gutter along the roads is not allowed, since this obstruction prevents runoff from flowing across vegetation within the right-of-way and requires storm drain systems to convey runoff to the receiving water course. Once the road location is complete, the designer can progress to lot layout and impervious cover management.

1/5 Acre Lot Option - Single-family lots with centralized water and wastewater systems.

Average lot size = 1/5th of an acre (70 feet wide (street frontage) by 130 feet deep for a total area of 9,100 square feet.

IC average per lot = 3,550 square feet, which includes lot IC from Table 2-4 (2,500 square feet) and half of the street IC. Street is 30 feet wide. IC = 33% (includes lot area and ½ street right-of-way).

Reduce street width to 24 feet. Studies show safer driving conditions when streets are not constructed as wide boulevards. To overcome the concern for lack of street parking, the driveways are longer by recessing the garage resulting in a driveway length of 40 feet. An added benefit of an extended driveway is improved home appearance since the house and landscaping serve as the viewer's focal point, not the large plain garage door. Now, IC average per lot (including ½ street) based on street width reduction = 3,340 square feet = 31%.

Driveways are constructed of porous pavement to promote recharge into the soil to aid adjacent landscaping with a source of water and further disconnect roof top runoff from the street conveyance system. Using driveway length of 40 feet and width of 16 feet, an impervious cover credit of 576 square feet is computed based on Equation 2.1. Now, IC average per lot (including ½ street) = 2,764 square feet = 25%.

Depending upon slope within the development, the designer can use the **rooftop disconnection** credit when slopes are less than 5%. Or, if slopes exceed this amount, the rainwater harvesting credit can be equally effective at gaining substantial credit.

- Disconnection credit, assume flow length is 40 feet from the house to the roadside swale to gain a 40% credit per Table 2-3. Roof area is presumed to be 2,500 square feet minus the driveway area (640 square feet), or 1,860 square feet. Per Equation 2.5, IC credit = $1,860 * 0.40 = 744$ square feet. IC average per lot (including $\frac{1}{2}$ street) = $2,020$ square feet = 18.6%.

OR RAINWATER HARVESTING (if slopes exceed 5%)

- To gain a similar 40% impervious cover credit, the rain barrel volume to catchment area must equal 0.08 according to Figure 2-1. Presuming the entire runoff is directed to the rainwater collection basin, we multiply the factor of 0.08 from Figure 2-1 by the assumed roof area (1860 square feet) to obtain a volume of 148.8 cubic feet. Converting to gallons by multiplying by 7.48 gallons/cubic foot yields a storage volume of 1,113 cubic feet. Rounding up to 1,200 gallons, a runoff storage volume below a foundation porch could be 10' by 10.6' by 1.5' deep. The advantage of an in-foundation storage area is that all the downspouts can be directed to the storage area and the tank(s) are not visible. An overflow weir is necessary to pass flows in excess of the storage volume to the adjacent landscape. In addition, a small sedimentation chamber is appropriate to settle solids and dust in a localized area to ease maintenance. Also, the use of gutter overflows and other techniques are appropriate to prevent rainwater from entering the home in the event of pipe blockage.

Now, using either rainwater harvesting or disconnected impervious cover or a combination of both within a development, the IC now equals 18.6%.

Last but not least, use the **conservation landscaping stormwater credit** throughout the entire project by minimizing turf area and maximizing use of native soils, trees, shrubs, and perennials to contain runoff on-site. See the photographs and lot plan on the web at www.lcra.org to gain a visual perspective of this BMP. Another feature is limited chemical use, reduced water demand, and less homeowner time to maintain their landscape. Impervious cover credit equals 5% when this type of landscape is mandated throughout the development by deed restriction and plat note.

After applying the above credits, the effective development impervious cover = 13.6%, which gains compliance with the alternate standards. No water quality basins or design calculations are necessary. The designer prepares the erosion control plan and other details that define the stable conveyance of runoff from the site improvements to the receiving water courses or buffer zones.

This assessment ignores creek buffer zones and other undeveloped areas, so the impervious cover assumptions are conservative by nature. If undeveloped areas are included in a development, then one of the above credits may not be necessary to achieve alternate standards compliance.

2.1.2 Example Alternate Standards – 1/2 acre lot using stormwater credits to gain alternate standards compliance

Below, a single-family development option is presented that maximizes the use of existing soils and native vegetation and combines stormwater credits with sound hydrologic design to protect water quality and avoid the cost and perpetual maintenance of structural water quality controls. The most important aspect of sound hydrologic design is configuring the development to work with the existing topography and vegetation. Whenever possible, roads should be located along ridgelines so runoff can sheet flow from the road and out of the right-of-way. This avoids roadside ditches that concentrate runoff, and then prove challenging to stabilize due to the steep terrain found in many developments. In addition, curb and gutter along the roads is not allowed, since this obstruction prevents runoff from flowing across vegetation within the right-of-way and requires storm drain systems to convey runoff to the receiving water course. Once the road location is complete, the designer can progress to lot layout and impervious cover management.

1/2 Acre Lot Option - Single-family lots with centralized water and on-site sewage disposal.

Average lot size = 1/2 of an acre (100 feet wide (street frontage) by 220 feet deep for a total area of 22,000 square feet.

IC average per lot = 6,500 square feet, which includes lot IC from Table 2-4 (5,000 square feet) and half of the street IC. Street is 30 feet wide. IC = 26.5% (based on 6500/24,500) (includes lot area and 1/2 street right-of-way).

Reduce street width to 24 feet. Studies show safer driving conditions when streets are not constructed as wide boulevards. To overcome the concern for lack of street parking, the driveways are longer by recessing the garage resulting in a driveway length of 50 feet. Added benefit of extended driveway is improved home appearance since house and landscaping serve as focal point, not the large plain garage door. Now, IC average per lot (including 1/2 street) based on street width reduction = 6,200 square feet = 25.3%.

Often, lots of this size are constructed in areas with slopes in excess of 5%, thus, they are not able to use the disconnected impervious cover credit. However, **rainwater harvesting** may be more feasible due to large lots, need for irrigation water, and the ability to conceal rainwater tanks if storage is desired external to the house. The developer also intends to use the **landscape conservation credit** of 5%, so the process begins by determining the rainwater storage volume. First, we must compute the roof area by subtracting the driveway area which is assumed to be 50' by 16' or 800 square feet. Roof area is 5,000 – 800 = 4,200 square feet. However, due to size of house, we assume that only 75% of the roof area can be directed to the rainwater storage tank, thus, catchment area = 4,200 * 0.75 = 3,150 square feet. Our goal is to get to a 20% impervious cover level through rainwater harvesting, then, the additional 5% via conservation landscaping. Since we know the area of the lot and 1/2 the right-of-way

equals 24,500, we multiply this by 0.2 to find the impervious cover level we are seeking = 4,900 square feet. Thus, we need to reduce impervious cover by 1,300 feet (6,200 – 4,900). Since the catchment area equals 3,150 square feet, we divide 1,300 by 3,150 to yield a 41% impervious cover reduction at the house to get our project impervious cover to 20%. Using Figure 2-1, and a 41% impervious cover reduction, we find the rain barrel volume to catchment area ratio to be 0.085. Now, multiplying 0.085 by the catchment area of 3,150 square feet results in a tank volume of 268 cubic feet. Converting to gallons by multiplying by 7.48 gallons/cubic foot yields a storage volume of 2,003 gallons. To achieve this volume, a runoff storage tank below a porch could be 15' by 12' by 1.5' deep. Or, storage tanks could be added to the home exterior. The advantage of an in-foundation storage area is that the downspouts can be easily directed to the storage area and the tank(s) are not visible. An overflow weir is necessary to pass flows in excess of the storage volume to the adjacent landscape. In addition, a small sedimentation chamber is appropriate to settle solids and dust in a localized area to ease maintenance. Also, the use of gutter overflows and other techniques are appropriate to prevent rainwater from entering the home in the event of pipe blockage. Project IC now equals 20%.

Last but not least, use the **conservation landscaping stormwater credit** throughout the entire project by minimizing turf area and maximizing use of native soils, trees, shrubs, and perennials to contain runoff on-site. See the photographs and lot plan on the web at www.lcra.org to gain a visual perspective of this BMP. Another feature is limited chemical use, reduced water demand, and less homeowner time to maintain their landscape. Impervious cover credit equals 5% when this type of landscape is mandated throughout the development by deed restriction and plat note.

After applying the above credits, the effective development impervious cover = 15%, which gains compliance with the alternate standards. No water quality basins or design calculations are necessary. The designer prepares the erosion control plan and other details that define the stable conveyance of runoff from the site improvements to the receiving water courses or buffer zones.

This assessment ignores creek buffer zones and other undeveloped areas, so the impervious cover assumptions are conservative by nature. If undeveloped areas are included in a development, then one of the above credits may not be necessary to achieve alternate standards compliance.

Example BMP Design - Single-Family Subdivision Project

- Project: Fifty (50) acre single family development in the Highland Lakes Ordinance jurisdiction,
- Lot Yield: The developer desires three lots per acre,
- Topography: Slopes vary from 2 to 15% within the 50 acre tract, two distinct drainage areas, and
- Soils: Brackett and Tarrant soils as commonly found in the region.

This example will look at one 20-acre drainage area within the development.

Step 1 – Define creek buffer zones beginning at waterways with 5 acres of drainage area and greater.

Step 2- Determine potential to comply with alternate standards. Total impervious cover is 25% and impervious cover in one of the individual development area is 35%, thus, this project can not comply with alternate standards.

Step 3- Design project to comply with Performance Standards found in Section 5 of the Ordinance and detailed in Chapter 2 of this manual.

- a) *Pre-development Planning Meeting.* Planner prepares conceptual plan for development outside the buffer zone, designing with drainage in mind by utilizing topography and slopes to minimize cut and fill for development construction. In addition, minimal land clearing is proposed, thus, construction sediment can be more effectively managed. Pre-development planning meeting is conducted at the site with LCRA staff to review proposed development project and water quality management approaches. Recommendations are provided and the subdivision plan is slightly modified to promote more sheet flow and natural drainage conveyance.
- b) *Construction Phase Erosion and Sediment Control* design will be detailed and minimize the concentration of flow. In areas of concentrated flow, sediment basins or other stabilization methods will be used to prevent scour and sediment discharge. Construction phasing will be defined and coordinated with construction limits. The proper sediment controls such as silt fence and rock berms will be selected based upon upstream contributing drainage area. Once areas are disturbed, revegetation will occur as soon as possible through broadcast seeding, hydromulch, compost/seed distribution, and soil protection blankets when necessary. The goal of the erosion sediment control design is to minimize land clearing to reduce erosion potential, then stabilize with vegetation in a rapid manner.
- c) *Water Quality Volume (WQV)/Design* computations for the structural basin to manage pollutants and channel erosion. Design volume computed by the use of Equations 2.9 and 2.10.

Drainage Area = 20 acres
Impervious cover = 35%
Runoff volume = 0.67 inches from Eq. 2-9
 $WQV = (0.67 \text{ inches}) * (20 \text{ acres}) * (43560/12) = 48,642 \text{ cubic feet (Eq. 2-10)}$

Designer selects the use of an extended detention (ED) basin to minimize maintenance concerns and improve aesthetics over sand filter basins. To account for potential sedimentation within the extended detention basin, the water quality volume must be increased by 5%. Basin located adjacent to buffer zone.

$BMP \text{ Volume} = WQV * 1.05 = 51,074 \text{ cubic feet.}$

Basin Depth = 4 feet

Basin Area is approximately 0.6 acres (200 feet by 130 feet)

An extended detention basin has a removal efficiency of nearly 70% for total suspended sediment and 45% for total phosphorus. Additional treatment is necessary.

Using Table 2-9 Sizing Requirements for Vegetated Filter Strips (VFS) and Infiltration BMPs in Series with Structural BMP (Up-gradient Area Method), the following is computed:

Up-gradient of ED basin, vegetated filter strip area = $48,642 * 0.53 = 0.59 \text{ acres}$

Down-gradient of ED basin, vegetated filter strip area = $48,642 * 0.2 = 0.22 \text{ acres}$

Infiltration basin volume downstream ED basin = $48,642 * 0.058 = 2,822 \text{ cu. ft}$

Infiltration trench length downstream of ED basin = $48,642 * 0.006 = 292 \text{ linear ft.}$ and includes vegetated filter strip 15 feet in width.

Trench area = 8 square feet per Table 2-9 so trench volume = $292 * 8 = 2,336 \text{ cu. ft.}$

A soil evaluation with LCRA staff near the proposed ED basin site revealed appropriate conditions for stormwater infiltration. Based on bore hole results, a trench depth of two feet was selected in combination with a width of four feet.

At this point, the designer prepares the design of the ED basin and infiltration trench, including the basin divider berm and other features to enhance sedimentation and pollutant removal. The basin has two stages to operate similar to a sedimentation-filtration pond, with the difference being no sand filter. However, a subsurface under-drain pipe is included to promote some filtering and ease basin maintenance by minimizing standing water. When full, the pond is designed to drain in 48 hours, which equals an average discharge rate of 0.3 cubic feet per second.

To promote sheet flow discharge from the basin and further increase pollutant management, the designer takes advantage of the infiltration trench to serve as the flow spreading device. Discharge will be through a gravity pipe system to evenly distribute the discharge to the trench. Runoff exiting the trench will drain across an engineered filter strip at a width of 15 feet up-gradient of the buffer zone. To check the flow spreading length, spreading device length (L) = $5 * Q_{1\text{year dev}}$, where $Q_{1\text{year dev}} = 25$ cfs, thus, $L = 5 * 25 = 125$ feet. In this example the infiltration trench length is 292 feet which exceeds the requirement of 125 feet so the condition is met.

ED basin discharge has been converted to sheet flow via the infiltration trench to a narrow vegetated filter strip. Now, runoff that is released from the infiltration trench flows across the buffer zone towards the creek. With the minimum buffer zone width of 25 feet, the natural buffer will have the ability to further filter and infiltrate stormwater runoff. Since the buffer area is not constructed, the natural topography may contain depression storage and other hydrologic losses to aid in further reducing runoff in most storm events.

- d) *Water Quality Education.* To minimize pollution at the source, LCRA staff will visit the neighborhood association at least once per year to provide programs and materials on proper lawn care and chemical disposal. Also, each new resident will receive a packet of information concerning lawn maintenance, car care, and other housekeeping tips to minimize the introduction of chemicals into the watershed.
- e) *Maintenance Permit.* Since this project constructed an ED water quality basin with infiltration trench, the owner/operator of the facility must enter into an agreement with LCRA to ensure proper and timely facility maintenance. The Maintenance Permit will specify the timing of trash collection, vegetation mowing, vegetation removal, sediment removal, and inspect other hydraulic functions for proper basin and trench operation. LCRA will inspect at least one time each year, if not more frequently, and provide reports to the owner/operator. If the owner does not respond to maintenance requests, LCRA has enforcement authority to ensure BMP system maintenance.

Example BMP Design - Large Commercial Development Project

Project: 10 acre commercial development in the Highland Lakes Ordinance jurisdiction

Topography: Slopes vary from 2 to 5% within the 10 acre tract

Soils: Brackett and Tarrant soils as commonly found in the region

This example will look at one drainage area within the commercial development.

Step 1 – Define creek buffer zones beginning at creeks with 5 acres of drainage area.

Step 2- Determine potential compliance with alternate standards. Total impervious cover is 80% and project greater than 3 acres in area. Project can not comply with alternate standards.

Step 3- Design project to comply with Performance Standards found in the Ordinance.

Pre-development Planning Meeting Planner prepares conceptual plan for development outside the buffer zone, designing with drainage in mind by utilizing topography and slopes to minimize cut and fill for development construction. Pre-development planning meeting is conducted at the site with LCRA staff to review proposed development project and water quality management approaches. Recommendations are provided on applicable water quality management basins.

Erosion and Sediment Control design will be detailed in nature and minimize the concentration of flow. In areas of concentrated flow, the water quality basin will be rough cut and serve as the sedimentation basin. The proper sediment controls such as silt fence and rock berms will be selected based upon upstream contributing drainage area. Once areas are disturbed, revegetation will occur as soon as possible through broadcast seeding, hydromulch, compost/seed distribution, and soil protection blankets when necessary.

Water Quality Volume (WQV)/Design computations for the structural basin to manage pollutants and channel erosion. Compute design volume Equations 2.9 and 2.10.

Drainage area = 10 acres

Impervious cover = 80%

Runoff volume = 1.41 inches from Eq. 2-9

$WQV = (1.41 \text{ inches}) * (10 \text{ acres}) * (43560/12) = 51,183 \text{ cubic feet (Eq. 2-10)}$

$Q_{1\text{-year dev}} = 18 \text{ cfs}$

Designer selects the use of a bioretention basin since this permanent BMP can achieve the pollutant management goals without other BMPs. Bioretention can be a heavily landscaped facility, therefore, its curbside appearance can be appealing when properly maintained. To account for potential sedimentation within the bioretention basin, the water quality volume must be increased by 5%.

BMP Volume = WQV * 1.05 = 51,183 * 1.05 = 53,742 cubic feet.

However, the designer has the option to use a wet vault as identified in Chapter 4 as a pre-treatment device. Use of a properly sized wet vault will not require the 5% increase in storage volume for potential sedimentation. In this example, the designer chooses to use a wet vault, thus, the basin does not need to be increased by 5% to account for sedimentation. Added benefit of wet vaults is the management of a portion of sediment, oil, grease, and trash in one location for easier maintenance and better basin aesthetics.

Basin volume = 51,183 cubic feet

Maximum basin depth = 2 feet

Basin Area is approximately 0.75 acres, (approximately 220 by 150 feet), fits within the two acres of pervious cover.

To promote sheet flow discharge from the basin and further increase pollutant management, the designer has the option to discharge to a filter strip, infiltration trench, or level spreader. The designer chooses the infiltration trench concept so discharge can occur below ground level since this works better with the under-drain system in the bioretention facility. Discharge will be through a gravity pipe system to evenly distribute the discharge. The infiltration trench must have a minimum width and depth of 2 feet and be located upstream of the buffer zone. The infiltration length is determined by multiplying the developed one-year peak discharge by 5. Thus, trench $L = 5 * Q_{1\text{-year dev}}$. In this example, the computation of $Q_{1\text{-year dev}} = 18$ cfs, then, the infiltration trench $L = 5 * 18 = 90$ feet. While the infiltration trench will not contain the entire runoff volume from the 1-year storm, it will generate sheet flow to the buffer zone.

Bioretention basin discharge has been converted to sheet flow via the above flow spreading device. Now, runoff that is released from the infiltration trench flows across the buffer zone towards the creek. With the minimum buffer zone width of 25 feet, the natural buffer will have the ability to further filter and infiltrate stormwater runoff. In addition, the slow release of the stormwater runoff tends to mimic the natural runoff conditions, thus, creek erosion is also managed.

Maintenance Permit Since this project constructed a bioretention basin and a wet vault, the owner/operator of the facility must enter into an agreement with LCRA to ensure proper and timely facility maintenance. The Maintenance Permit will specify the timing of trash collection, vegetation mowing, vegetation removal, sediment removal, and inspect other hydraulic functions for proper basin operation. LCRA will inspect the basin at least one time each year, if not more frequently, and provide reports to the owner/operator. The wet vaults will receive quarterly inspection. If the owner does not respond to maintenance requests, LCRA has enforcement authority to ensure the necessary maintenance work is performed.

Hydrology and Hydraulics Reference Tables

Rational Method Runoff Coefficients

(Source: 1981 City of Austin Drainage Criteria Manual)

		1-year	10-yr	25-yr
Streets				
	Asphaltic	0.69	0.82	0.88
	Concrete	0.75	0.87	0.93
Drives & Walks (Concrete)		0.75	0.87	0.93
Roofs		0.75	0.87	0.93
Lawns, Sandy Soil				
	Flat, 0-2%	0.05	0.07	0.08
	Average, 2-7%	0.10	0.12	0.13
	Steep, over 7%	0.14	0.18	0.19
Lawns, Clay Soil				
	Flat, 0-2%	0.15	0.19	0.20
	Average, 2-7%	0.18	0.23	0.24
	Steep, over 7%	0.25	0.31	0.33
Undeveloped Woodlands and Pastureland, Sandy Soil				
	Flat, 0-2%	0.10	0.12	0.13
	Average, 2-7%	0.16	0.21	0.22
	Steep, over 7%	0.25	0.31	0.33
Undeveloped Woodlands and Pastureland, Clay Soil				
	Flat, 0-2%	0.25	0.31	0.33
	Average, 2-7%	0.32	0.41	0.44
	Steep, over 7%	0.41	0.51	0.55

Rainfall Intensity

(Source: City of Austin Drainage Criteria Manual)

Tc	1-year I, in/hr	10-yr I, in/hr	25-yr I, in/hr
5	5.5	8.64	9.84
10	4.3	7.29	8.4
15	3.7	6.33	7.36
30	2.6	4.62	5.46
60	1.65	3.1	3.72

**1-Year, 3-Hour Design Storm Rainfall Distribution
Cumulative Values (inches), 5 minute time
increment**

<u>time,</u> <u>min</u>	<u>1-year</u>	<u>10-year</u>	<u>25-year</u>
5	0.006	0.034	0.044
10	0.012	0.070	0.091
15	0.019	0.108	0.140
20	0.026	0.150	0.190
25	0.034	0.190	0.250
30	0.043	0.240	0.310
35	0.053	0.290	0.380
40	0.064	0.350	0.450
45	0.077	0.410	0.530
50	0.092	0.480	0.620
55	0.110	0.560	0.720
60	0.134	0.650	0.840
65	0.166	0.760	0.980
70	0.212	0.900	1.150
75	0.287	1.070	1.360
80	0.384	1.310	1.650
85	0.542	1.670	2.190
90	0.802	2.390	3.010
95	1.262	2.890	3.530
100	1.462	3.180	3.880
105	1.587	3.380	4.130
110	1.688	3.530	4.320
115	1.746	3.650	4.470
120	1.784	3.750	4.600
125	1.811	3.840	4.710
130	1.832	3.910	4.800
135	1.849	3.980	4.890
140	1.863	4.040	4.960
145	1.875	4.090	5.030
150	1.885	4.140	5.100
155	1.894	4.190	5.160
160	1.902	4.230	5.210
165	1.910	4.270	5.260
170	1.917	4.300	5.310
175	1.924	4.340	5.360
180	1.930	4.370	5.400

MANNING'S "n" FOR OVERLAND FLOW AND SHALLOW CONCENTRATED FLOW

<u>Manning's "n"</u>	<u>Condition</u>
0.016	Concrete (rough or smoothed finish)
0.02	Asphalt
0.1	0-50% vegetated ground cover, remaining bare soil or rock outcrops, minimum brush or tree cover
0.2	50-90% vegetated ground cover, remaining bare soil or rock outcrops, minimum- medium brush or tree cover
0.3	100% vegetated ground cover, medium- dense grasses (lawns, grassy fields etc.) medium brush or tree cover
0.6	100% vegetated ground cover with areas of heavy vegetation (parks, green- belts, riparian areas etc.) dense under- growth with medium to heavy tree growth

MANNING'S "n" FOR NEW OR ALTERED CHANNELS

<u>Manning's "n"</u>	<u>Type of Channel and Description</u>
0.04	1. Grass lined
0.045	a. Bermuda (with regular mowing)
0.06	b. St. Augustine (with regular mowing)
	c. Native grasses and vegetation not mowed regularly
0.02	2. Concrete
0.015	a. Concrete lined (rough finish)
0.025	b. Concrete lined (smooth finish-culverts)
	c. Concrete rip-rap (exposed rubble)
0.035	3. Gabion
0.025	4. Rock-cut

Pre-Development Planning

1.1 Site Planning Process

Preventing problems is much more efficient and cost-effective than attempting to correct problems after the fact. Sound land use planning decisions based on the site planning principles discussed in this chapter are essential as the first, and perhaps the most important, step in managing construction and post-development runoff problems. All new development plans (e.g., subdivisions, shopping centers, industrial parks, office centers) and redevelopment plans should be based upon accurate topographic data, up-to-date aerial photographs, field reconnaissance of the site, and knowledge of unique resources that serve as an amenity and add value to the project. Site planning can then proceed to minimize drainage impacts, avoid the concentration of flow to the maximum extent practical, and use the natural topography and vegetation to manage stormwater quality and quantity. Comprehensive site planning can reduce impervious cover and stormwater runoff volume, potentially gaining compliance with Alternate Standards and avoiding the need for costly structural water quality basins. In the end, good site planning can protect the natural resources, increase the project financial return, yet minimize long-term maintenance and liability issues.

Developing a site plan requires a careful step-by-step analytical approach, which often includes the following steps:

- Conduct a site evaluation. Assess existing natural features and determine suitability for the proposed development activity.
- Develop site maps. These allow visual inspection and analysis of site features and their relationship to alternative site development plans. The maps should include topographic maps, aerial photographs, slope maps, soil maps, and utility information.
- Review site plan goals. Goals should properly address requirements of local, state and federal laws, ordinances, permitting regulations, comprehensive plans, and land development codes.
- Develop and integrate the individual components of the site plan. Each component should include goals, desired performance, design considerations for chosen BMPs, operation and maintenance needs, costs, and scheduling.

Stormwater Runoff Planning

The following guidance details considerations in stormwater runoff planning which should be based on and support a plan for the entire drainage basin.

- a. The runoff management system should mimic and use the features and functions of the natural runoff system, which is largely capital, energy, and maintenance cost free.
- b. Each development plan should carefully map and identify the existing natural system.
- c. The volume, rate, and timing of runoff after development should closely approximate the conditions before development.
- d. In parking areas, pervious cover designs such as porous pavement, geogrid blocks, and grass cover should be incorporated into the site plan.
- e. Runoff should never be discharged directly to receiving waters. Runoff should be routed over a longer distance, through grassed conveyances (swales), vegetated buffers, creek buffers, and other practices that increase overland sheet flow.
- f. Plan, construct, and stabilize runoff management systems, especially those emphasizing vegetative practices, before development.
- g. Design the runoff management system beginning with the project's outlet or point of outflow.
- h. Whenever possible, follow the topography to construct the components of the runoff management system. This step will minimize erosion and stabilization problems caused by excessive velocities.
- i. Runoff, a component of the total water resources, should not be casually discarded but used to replenish those resources.
- j. Whenever practical, integrate multiple-use temporary storage basins into the management system. Too often, planned facilities are conventional, unimaginative, aesthetically unpleasing ponds. Recreational areas (e.g., ballfields, tennis courts, volleyball courts), greenbelts, neighborhood parks, and even parking facilities provide excellent settings for temporary runoff storage.
- k. Additional storage can be provided by including rainwater harvesting and other stormwater credits.
- l. Retain vegetated buffer strips in their natural state and protect the buffer zones along the banks of all water bodies.
- m. Maintain the runoff management system. Failure to provide proper maintenance reduces the system's pollutant removal efficiency and hydraulic capacity.

- n. Provide financing mechanisms for maintenance activities. All BMPs require maintenance to assure proper functioning.
- o. Minimize impervious surface area. See Table 2- for guidance, which can also be found in the Appendix.
- p. Preserve and mimic the natural runoff system by routing roof runoff to pervious areas, using grassy swales instead of storm drains, and use landscaping techniques to retain runoff.
- q. Consider using the characteristic “stair step” topography of the Hill Country to mitigate the increase in runoff from developed areas. Guidance is found in this manual.

The following table can be used to aid in site planning and preparing the pre-development planning meeting. The above items are not required to be part of the pre-development planning meeting, but are suggested for consideration in creating the preliminary plan.

Pre-Development Planning Checklist

Complete	Development Layout	Complete	Impervious Cover Management	Comments
	Property map		Reduce street width	
	Aerial Photograph Overlay		Reduce street length	
	Topographic Map Overlay		Sidewalks on one side of the street	
	Soils map overlay		Shorter driveways	
	Delineate floodplains		Shared driveways and parking areas	
	Delineate creek buffers		Reduced cul-de-sac radii	
	Identify natural areas, wetlands, terraces		Vegetated remote or overflow parking	
	Identify steep slopes (> 10%)			
	Recharge and discharge areas			
	Identify natural areas (terraces, meadows, deep soil areas) for stormwater management		Cluster development	
	Thorough field reconnaissance of site		Reduce setbacks and frontage	
	Locate natural resources, specimen trees, seeps, bluffs, and other features		Flexible minimum lot sizes	
	Layout roads along the ridge line		Disconnected roof down spouts	
	Minimize road crossings of creeks		Roadside swales instead of curb and Gutter	
	Avoid using roads as first order tributaries		Pervious pavement	
	Use roadside swales, not curb and gutter		Rainwater collection	
	Define existing drainage patterns		Native landscaping	
	Hydrologic design to mimic natural drainage patterns			
	Avoid concentrated flow, maintain sheet flow		Natural area preservation	
	Achieve compliance with Alternate Standards		Use stormwater credits to achieve alternate standards compliance	
	Locate water quality basins at discharge points		Use stormwater credits to reduce water quality basin size	
	Select low maintenance BMPs with a good appearance (Chapter 4)			
	Prepare landscape plan for water quality basins using native plants			
	Complete the erosion control site rating form found In 2.6			

Buffer Zones

Natural buffer areas adjacent to creeks and drainage ways play an important role in maintaining pre-development water quality. The riparian vegetation stabilizes stream channels and floodplain areas, reducing the potential for creek erosion. In addition, they provide an area to filter overland flow from adjacent development projects. This filtering is beneficial during construction to retain sediment from up-gradient disturbed areas and also after construction as a BMP to polish stormwater discharged from water quality basins. There are many benefits provided by riparian buffer systems. Some of those benefits include:

- Increases pollutant removal,
- Increases the distance of impervious areas from the drainage/creek,
- Moderates overland flow,
- Discourages excessive storm drain systems,
- Increases property values,
- May prevent severe rates of soil erosion,
- Minimizes disturbance to steep slopes,
- Mitigates creek warming,
- Provides effective flood control,
- Helps protect nearby properties from the shifting and widening of the stream channel that occurs over time,
- Reduces small drainage problems and complaints by residents that are likely to experience backyard flooding, and
- Serves as the foundation for present or future greenways,

The purpose of the riparian buffer is to adequately protect waterways and aquatic resources from the short and long term impacts of development activities by providing a contiguous protection zone along the riparian corridor that is associated with natural drainage features. In many creeks, streams, and rivers, the floodplain is an integral part of the stream-riparian ecosystem. Due to natural topography and geomorphology, some streams are constrained to narrow valleys or ravines. The buffer zone width is based upon its drainage area or floodplain in Travis County. In Burnet and Llano County, the buffer zone will be established as a setback from the drainage /creek bank. The specific buffer widths are listed below.

Many scientists and engineers have evaluated the effectiveness of riparian buffers. They concluded that a riparian buffer approach is an effective tool to reduce overland flow to streams. They also found that riparian buffer effectiveness is dependent on the condition of the watershed and should be used in concert with upslope watershed management efforts.

Construction-Phase Erosion and Sediment Control

Introduction

This section provides guidance on planning the construction erosion control and site stabilization plan. Techniques are included to assist in rating development sites for erosion potential and suggesting the appropriate erosion and sediment control BMPs to manage construction sites and promote rapid vegetation growth.

Erosion and Sediment Control Planning

The following planning and construction practices were described by the U.S. Environmental Protection Agency (EPA, 1993) and North Carolina (North Carolina, 1993) to illustrate the types of measures that can be applied successfully to achieve a reduction in the amount of erosion occurring on active construction sites. These practices are used to reduce the amount of sediment that is detached during construction and to prevent sediment from entering runoff. **Erosion control is based on two main concepts: (1) disturb the smallest area of land possible for the shortest period of time, and (2) stabilize disturbed soils to prevent erosion from occurring.**

Development Siting

Review and consider all existing conditions in the initial site selection for the project. Select a site that is suitable rather than force the terrain to conform to development needs. Figure --3 illustrates a sound grading approach on the left and a destructive approach on the right. Ensure that development features follow natural contours. Steep slopes, areas subject to flooding, and highly erodible soils severely limit a site's use, while level, well-drained areas offer few restrictions. Any modification of a site's drainage features or topography requires protection from erosion and sedimentation. Instead, performance of careful planning to integrate natural landforms into the development plan will reduce erosion and sediment control costs and requirements.

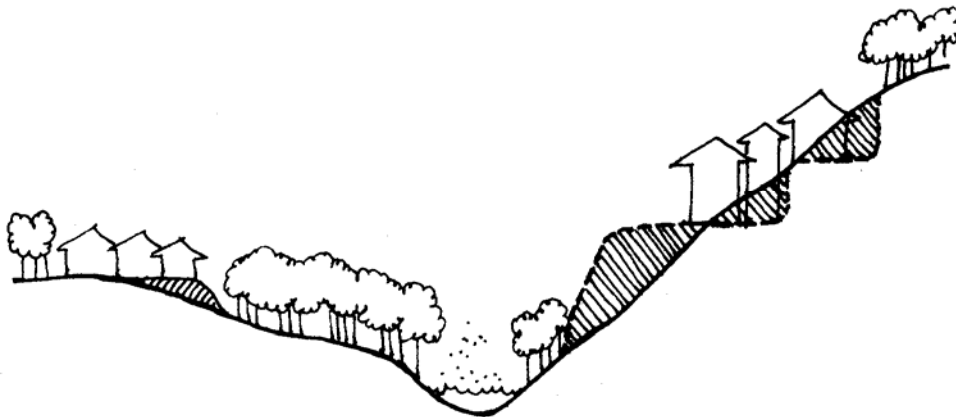

Figure -2-3 Examples of Proper and Improper Siting

(Proper approach on the left bank, improper approach on the right bank)

Project Scheduling

Often a project can be scheduled during the time of year that the erosion potential of the site is relatively low. In central Texas, rainfall amounts are generally lower during July and August and the hot temperatures quickly dry out exposed soils. During the wetter months (spring and fall), construction vehicles can easily turn the soft, wet ground into mud, which is more easily washed offsite.

Scheduling can be a very effective means of reducing the hazards of erosion. Schedule construction activities to minimize the exposed area and the duration of exposure. In scheduling, take into account the season and the weather forecast. Stabilize disturbed areas as quickly as possible.

Avoid area wide clearance of construction sites. Plan and stage land disturbance activities so that only the area currently under construction is exposed. As soon as the grading and construction in an area are complete, the area should be stabilized and/or vegetated.

Material Management

Locate potential pollutant sources away from steep slopes, streams, and critical areas. Material stockpiles, borrow areas, access roads, and other land-disturbing activities can often be located away from critical areas such as steep slopes, highly erodible soils, and areas that drain directly into geologically sensitive features. The exposure of litter, construction debris, and chemicals to stormwater should be minimized to prevent them from becoming a pollutant source. Daily litter removal and screening outfalls and storm drain inlets may help retain these materials onsite.

Stockpile topsoil and reapply to revegetate site. Because of the high organic content of topsoil, it cannot be used as fill material or under pavement. Topsoil is typically removed when a site is cleared. Since topsoil is essential to establish new vegetation and typically contains native viable seed material, it should be stockpiled and then reapplied to the site for revegetation, if appropriate. Although topsoil salvaged from the existing site can often be used, it must meet certain standards and topsoil may need to be imported onto the site if the existing topsoil is not adequate for establishing new vegetation.

Apply temporary erosion controls such as silt fence and berms around stockpiles to prevent sediment wash-off. In addition, spoils should not be stored within the 100-year floodplain where they can be disturbed during high flow conditions.

Vegetation Protection

By clearing only those areas immediately essential for completing site construction, buffer zones are preserved and soil remains undisturbed until construction begins (Figure-4). Physical markers, such as tape, signs, or barriers, indicating the limits of land disturbance, can ensure that equipment operators know the proposed limits of clearing. The area of the watershed that is exposed to construction is important in determining the net amount of erosion. Reducing the extent of the disturbed area will ultimately reduce sediment loads to surface waters. Existing or newly planted vegetation that has been planted to stabilize disturbed areas should be protected by routing construction traffic around the areas and protecting natural vegetation with fencing, tree armoring, retaining walls, or tree wells. Avoid disturbing vegetation on steep slopes or other critical areas.

Where possible, construction traffic should travel over areas that must be disturbed for other construction activity. This practice will reduce the area that is cleared and susceptible to erosion.

Tree armoring protects tree trunks from being damaged by construction equipment. Fencing can also protect tree trunks, but should be placed at the tree's drip line so that construction equipment is kept away from the tree. The tree drip line is the minimum area around a tree in which the tree's root system should not be disturbed by cut, fill, or soil compaction caused by heavy equipment. When cutting or filling must be done near a tree, a retaining wall or tree well should be used to minimize the cutting of the tree's roots or the quantity of fill placed over the roots.

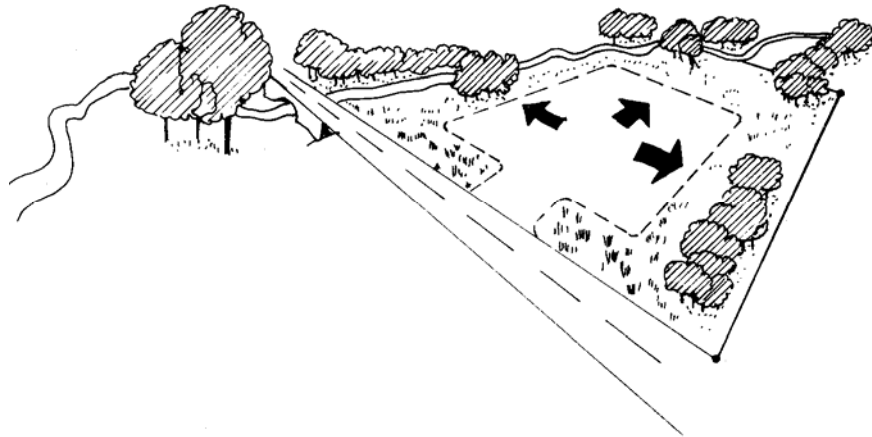

Figure 2-4 Example of Conservative Site Clearing

Protect Area from Upgradient runoff

Protect areas to be disturbed from stormwater runoff. Use dikes, diversions, and waterways to interrupt runoff and divert it away from cut-and-fill slopes or other

disturbed areas. To reduce on-site erosion, install these measures before clearing and grading.

Earth dikes, perimeter dikes or swales, or diversions can be used to intercept and convey runoff above disturbed areas (Figure 2-5). An earth dike is a temporary berm or ridge of compacted soil that channels water around or away from disturbed areas. A perimeter dike/swale or diversion is a swale with a supporting ridge on the lower side that is constructed from the soil excavated from the adjoining swale. These practices should be used to intercept flow from denuded areas or newly seeded areas to keep the disturbed areas from being eroded from the uphill runoff. The structures should be stabilized within 14 days of installation or as soon as practicable with vegetation, slope coverings or other appropriate erosion prevention measures. A pipe slope drain is a temporary pipe placed from the top of a slope to the bottom of the slope to convey concentrated runoff down the slope without causing erosion.

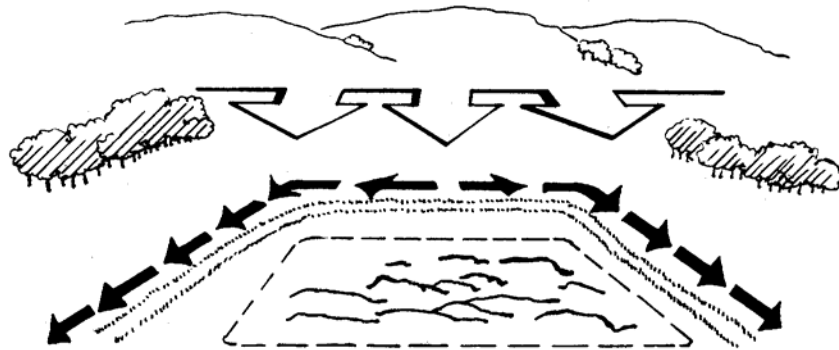

Figure 2-5 Diversion of Runoff away from Construction Area

Reduce Runoff Velocities

Keep runoff velocities low. Clearing existing vegetation reduces the surface roughness and infiltration rate and thereby increases runoff velocities and volumes. Use measures that break the slopes (Figure 2-6) to reduce the problems associated with concentrated flow volumes and runoff velocities. Practical ways to reduce velocities include conveying stormwater runoff away from steep slopes to stabilized outlets, preserving natural vegetation where possible, and mulching and vegetating exposed areas immediately after construction.

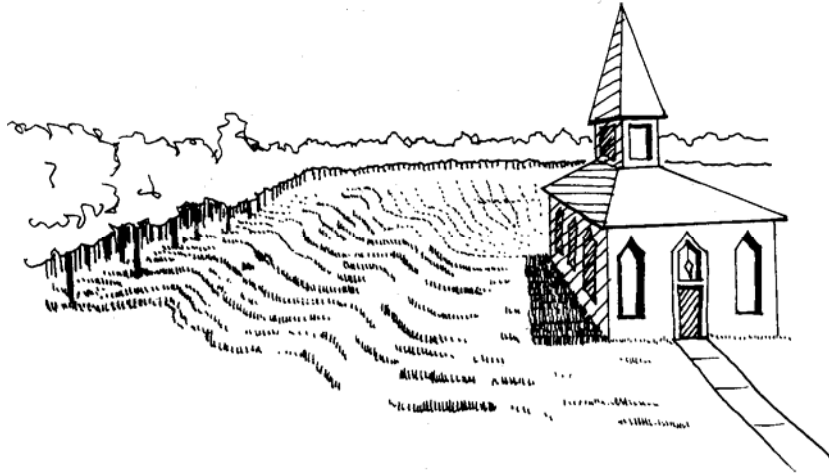

Figure 2-6 Slow Runoff by Breaking Slopes

Benches, terraces, or ditches break up a slope by providing areas of low slope in the reverse direction. This keeps water from proceeding down the slope at increasing volume and velocity. Instead, the flow is directed to a suitable outlet, such as a sediment basin or trap. The frequency of benches, terraces, or ditches will depend on the erodibility of the soils, steepness and length of the slope, and rock outcrops. This practice should be used if there is a potential for erosion along the slope.

Use retaining walls. Often retaining walls can be used to decrease the steepness of a slope. If the steepness of a slope is reduced, the runoff velocity is decreased and therefore, the erosion potential is decreased. Retaining walls also may actually encourage water to infiltrate rather than runoff, thereby helping maintain the natural hydrologic characteristics of a site.

Provide linings for urban runoff conveyance channels if necessary. Construction often increases the velocity and volume of runoff, which causes erosion in newly constructed channels. If the runoff during or after construction has excessive velocities, the designer can use the guidance in Chapter 3 to select the appropriate flow control BMP. The first choice of lining should be grass or sod since this reduces runoff velocities and provides water quality benefits through filtration and infiltration. If the velocity in the channel would erode the grass or sod, then soil protection blankets, riprap, or gabions can be used.

Use check dams. Check dams are small, temporary dams constructed across a swale or channel. They can be constructed of gravel and rock berms. They are used to reduce the velocity of concentrated flow and, therefore, to reduce the erosion in a swale or channel.

Site Stabilization

Removing the vegetative cover and altering the soil structure by clearing, grading, and compacting the surface increases an area's susceptibility to erosion. Apply stabilizing

measures as soon as possible after the land is disturbed (Figure 2-7). Plan and implement temporary or permanent vegetation, mulches, or other protective practices to correspond with construction activities. Protect channels from erosive forces by using protective linings and the appropriate channel design. Consider possible future repairs and maintenance of these practices in the design.

Seeding establishes a vegetative cover on disturbed areas. Seeding is very effective in controlling soil erosion once a vegetative cover of about 80% has been established. However, often seeding and fertilizing do not produce as thick a vegetative cover as do seed and mulch or netting. Newly established vegetation does not have as extensive a root system as existing vegetation and therefore is more prone to erosion, especially on steep slopes. Care should be taken when fertilizing to avoid untimely or excessive application. Since the practice of seeding and fertilizing does not provide any protection during the time of vegetative establishment, it should be used only on favorable soils in very flat areas and not in sensitive areas.

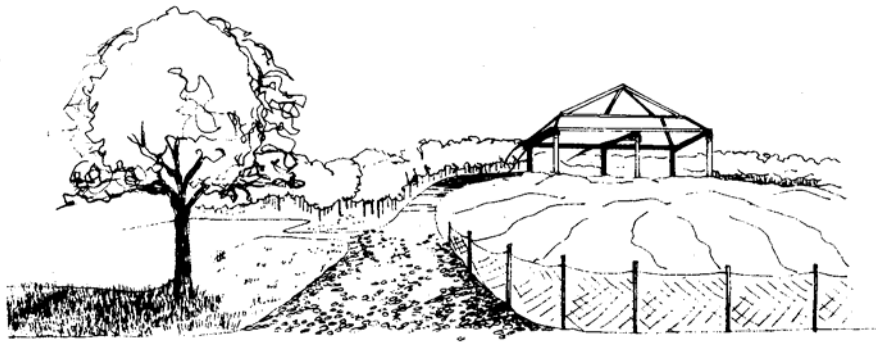

Figure 2-7 Stabilization of Disturbed Areas

The management of land by using ground cover reduces erosion by reducing the flow rate of runoff and the raindrop impact. Bare soils should be seeded or otherwise stabilized within 14 calendar days after final grading or where construction activity has temporarily ceased for more than 21 days. In very flat, non-sensitive areas with favorable soils, stabilization may involve simply seeding and fertilizing. Mulch and/or sod may be necessary on steeper slopes, for erodible soils, and near sensitive areas. Sediment that has escaped the site due to the failure of sediment and erosion controls should be removed as soon as possible to minimize offsite impacts. Permission should be obtained from adjacent land owners prior to offsite sediment removal.

Mulching/mats can be used to protect the disturbed area while vegetation becomes established. Mulching involves applying plant residues or other suitable materials on disturbed soil surfaces. Mulches/mats used include tacked straw, wood chips, and jute netting and are often covered by blankets or netting. Mulching alone should be used only for temporary protection of the soil surface or when permanent seeding is not feasible. The useful life of mulch varies with the material used and the amount of precipitation, but

is approximately 2 to 6 months. See Chapter 3 for guidance on selecting the appropriate materials.

During times of year when vegetation cannot be established, soil mulching should be applied to moderate slopes and soils that are not highly erodible. On steep slopes or highly erodible soils, multiple mulching treatments should be used. Erosion control blankets, filter fabric, and netting are available for this purpose. Before stabilizing an area, it is important to have installed all sediment controls and diverted runoff away from the area to be planted. Runoff may be diverted away from denuded areas or newly planted areas using dikes, swales, or pipe slope drains to intercept runoff and convey it to a permanent channel or storm drain. Reserved topsoil may be used to revegetate a site.

Consideration should be given to maintenance when designing mulching and matting schemes. Plastic nets are often used to cover the mulch or mats; however, they can foul lawn mower blades if the area requires mowing.

Sod can be used to permanently stabilize an area. Sodding provides immediate stabilization of an area and should be used in critical areas or where establishment of permanent vegetation by seeding and mulching would be difficult. Sodding is also a preferred option when there is high erosion potential during the period of vegetative establishment from seeding.

Because of the hardy drought-resistant nature of wildflowers, they may be more beneficial as an erosion control practice than turf grass. While not as dense as turfgrass, wildflower thatches and associated grasses are expected to be as effective in erosion control and contaminant absorption. Because thatches of wildflowers do not need fertilizers, pesticides, or herbicides, and the need for watering is minimal, implementation of this practice may result in cost savings. In 1987, Howard County, Maryland, spent \$690.00 per acre to maintain turfgrass areas, compared to only \$31.00 per acre for wildflower meadows. A wildflower stand requires several years to become established; however, maintenance requirements are minimal once the area is established.

Plan for Temporary Structural Controls

Retain Sediment on the Site. Even with careful planning, some erosion is unavoidable. The resulting sediment must be trapped on the site. Plan the location where sediment deposition will occur and maintain access for cleanout. Protect low points below disturbed areas by building barriers to reduce sediment loss. Whenever possible, plan and construct sediment traps and basins before other land-disturbing activities (Figure 2-8).

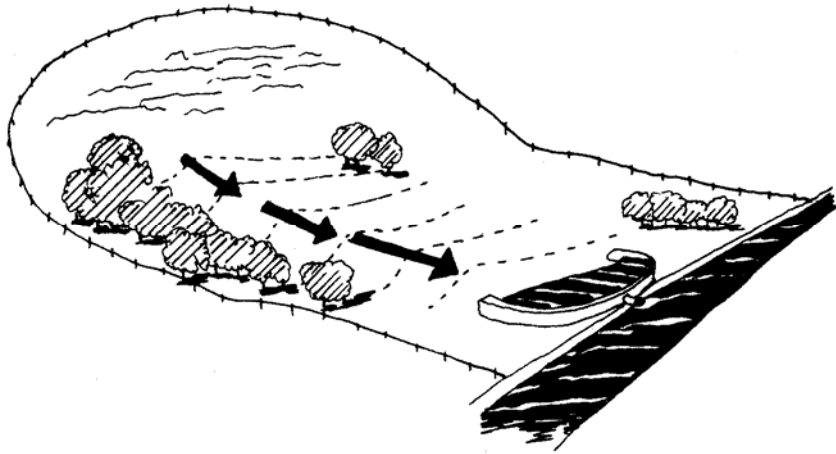

Figure 2-8 Retention of Eroded Sediment on Site

Soil Protection Blankets and Matting

Soil protection blankets and matting material are used as an aid to control erosion in critical areas such as slopes and channels and to assist in the establishment of protective vegetation. Material selection is based on site conditions (slope or channel condition and soil type). See the [LCRA Water Quality Management Technical Manual](#).

Install blankets per the manufacturer's recommendations. Proper installation of blankets and matting is necessary for these materials to function as intended. Proper anchoring of the material and preparation of the soil are two of the most important aspects of installation.

Notes:

1. Remove clods and rocks more than 1.5 inches in diameter and any foreign material that will prevent contact of the protective mat with the soil surface.
2. Fertilize and seed in accordance with seeding or other type of planting plan.
3. Dig anchor trenches 6 inches wide and 12 inches in depth.
4. Use enough mat to allow a minimum of 2 inch turnover at bottom of trench for stapling, while maintaining the top edge flush with the soil surface.
5. Make sure matting is uniformly in contact with the soil.
6. Secure lap joints and staple (flush with the ground).
7. Inspect blankets and matting weekly and after each rain event (of 0.5 inch or more) to locate and repair any damage. Apply new material if necessary to restore function.
8. Temporary irrigation should be provided. Significant rainfall (on-site rainfall of 0.5 inch or greater per week) may allow watering to be postponed until the next scheduled irrigation.

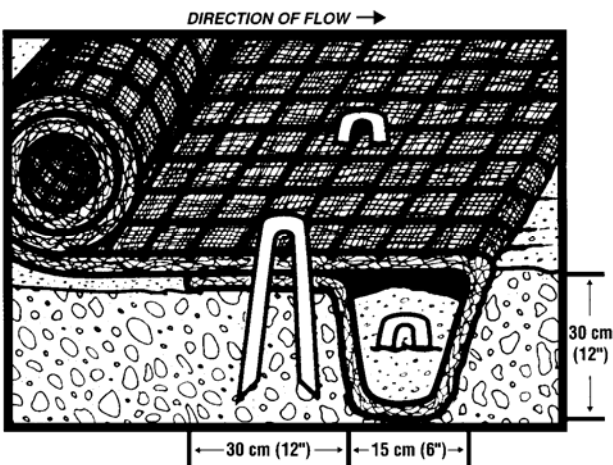

Initial Anchor Trench for Blankets and Mats

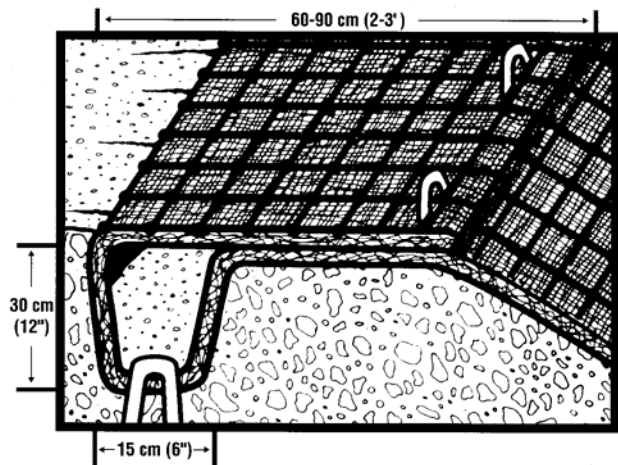

Terminal Anchor Trench for Blankets and Mats

Temporary Construction Entrance/Exit

The purpose of a temporary construction entrance is to provide a stable entrance/exit condition from the construction site and keep mud and sediment off of roads.

Notes:

1. Use 4 to 8 inch washed stone and place with a minimum thickness of 8 inches.
2. Use geotextile fabric with an approximate weight of 4 oz/yd² as needed to improve stability.
3. The minimum width of the entrance/exit should be 12 feet or the full width of exit roadway, whichever is greater.
4. The construction entrance should be at least 50 feet long.
5. Divert all surface runoff and drainage from the stone pad to a sediment trap or basin if necessary.
6. Inspect entrance/exit and after each rain event (of 0.5 inch or more). Repair any damage by adding stone and/or cleaning any measures used to trap sediment.
7. Promptly remove all sediment spilled, dropped, washed or tracked onto public rights-of-way. Dispose of sediment in a manner that will not cause additional siltation.
8. When construction is complete, properly dispose of any sediment buildup and restore the prior location of the entrance/exit.

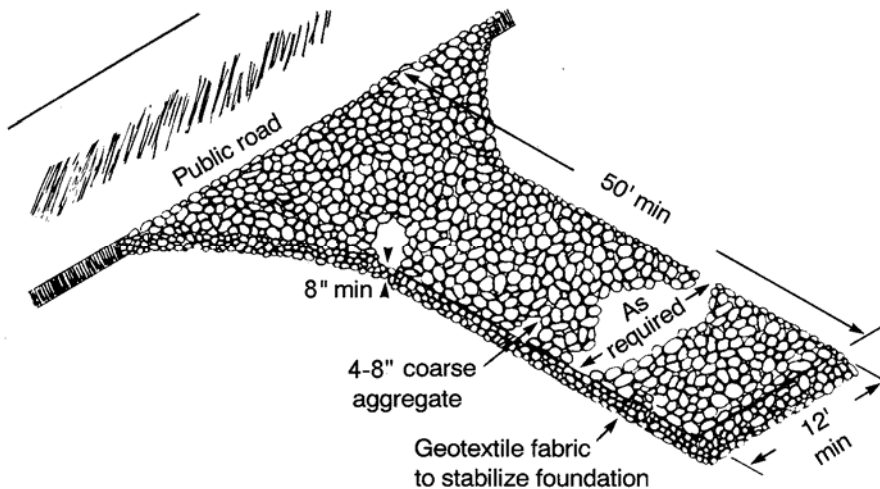

Schematic of Temporary Construction Entrance/Exit

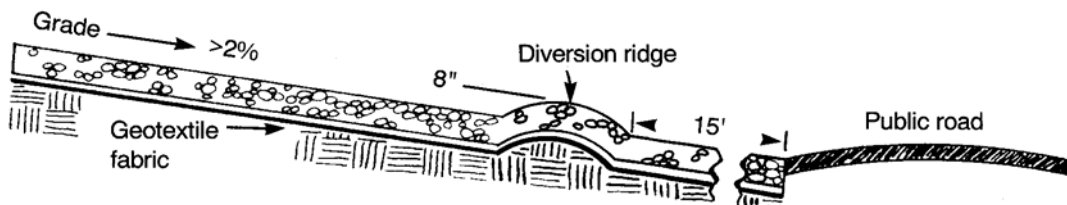

Cross-section of a Construction Entrance/Exit

Silt Fence

The purpose of a silt fence is to intercept and detain water-borne sediment from unprotected areas of a limited extent (maximum contributing drainage area of 2 acres).

Notes:

1. Use polypropylene, polyethylene or polyamide woven or nonwoven fabric (36 inches wide, weighing 4 oz/yd) and 2" x 4", 12 gauge minimum woven wire backing.
2. Use steel fence posts, at least 4 feet long, embedded 1-foot deep and spaced not more than 8 feet on center.
3. Toe in the silt fence so that the down-slope face of the trench is flat and perpendicular to the line of flow (6" x 6" trench). Where fence cannot be trenched in (e.g., pavement or rock outcrop), weight fabric flap with 3 inches of pea gravel on uphill side to prevent flow from seeping under fence.
4. Use J-hooks as needed when silt fences cross contour lines to create catchment areas and slow flow velocity. Use J-hooks at downhill fence ends to prevent runoff from escaping around sides. Refer to the J-hook placement detail found below.
5. Inspect silt fences weekly and after each rain event (of 0.5 inch or more) to locate and repair any damage. Replace any torn fabric and repair any sections crushed or collapsed in the course of construction activity.
6. Remove sediment when buildup reaches 6 inches. Dispose of sediment in a manner that will not cause additional siltation.
7. When construction is complete, properly dispose of any sediment buildup and restore the prior location of the silt fence. The fence materials should be disposed of in an approved landfill or reused if in serviceable condition.

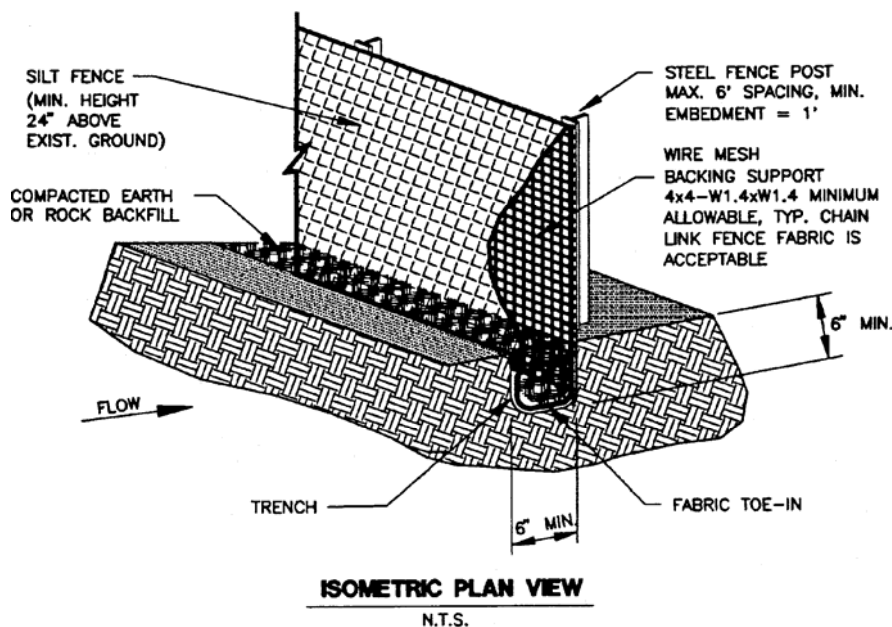

Schematic of a Silt Fence Installation

Recommended Silt Fence Spacing on Sloping Sites

	Soil Type		
Slope angle	Silty	Clays	Sandy
Very steep (1:1)	50 ft.	75 ft.	100 ft.
Steep (2:1)	75 ft.	100 ft.	125 ft.
Moderate (4:1)	100 ft.	125 ft.	150 ft.
Slight (10:1)	125 ft.	150 ft.	200 ft.

PLAN VIEW

I. SPACING REQUIREMENTS

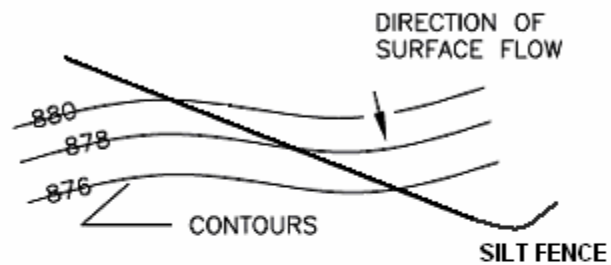
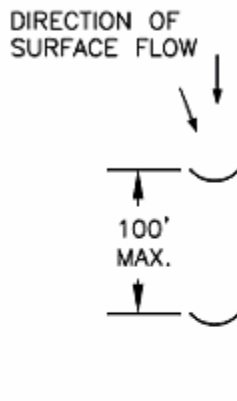

II. SIZING REQUIREMENTS:

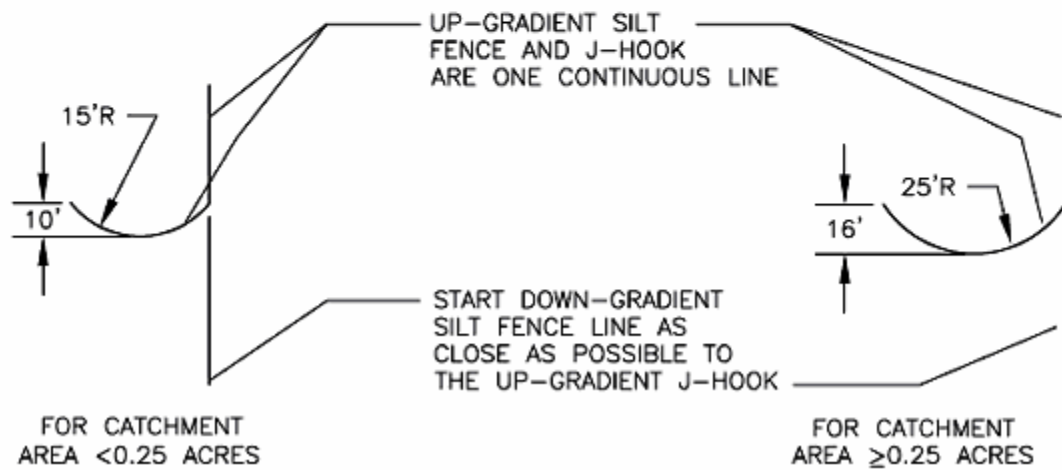

J-hook Placement Details

Rock Berms

The purpose of a rock berm is to serve as a check dam in areas of concentrated flow, to intercept sediment-laden runoff, detain the sediment and release the water in sheet flow.

Notes:

1. Use clean, open graded 3- to 5-inch diameter rock.
2. Use a woven wire sheathing (maximum opening of 1 inch and a minimum wire diameter of 20 gauge galvanized), and secure with shoat rings.
3. The height should be at least 18" and the top width of at least 2 feet.
4. Install berm along a constant contour and perpendicular to the flow path to prevent runoff from escaping around the sides.
5. Inspect weekly and after each rain event (of 0.5 inch or more) to locate and repair any damage.
6. Remove sediment when buildup reaches 6 inches. Dispose of sediment in a manner that will not cause additional siltation.
7. When construction is complete, properly dispose of any sediment buildup. The rock berm should be removed when the site has been revegetated, but may be left in place as a permanent BMP in certain cases (e.g. when used as a check dam in a constructed ditch or swale).

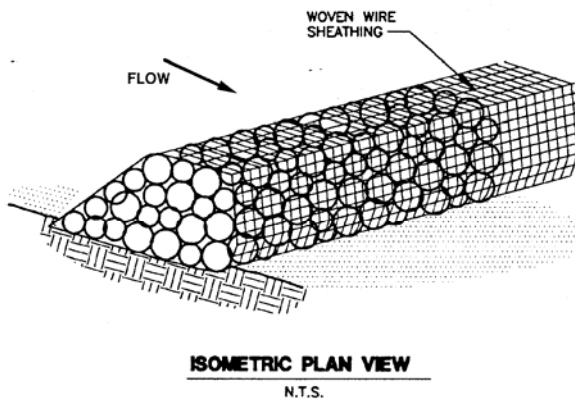
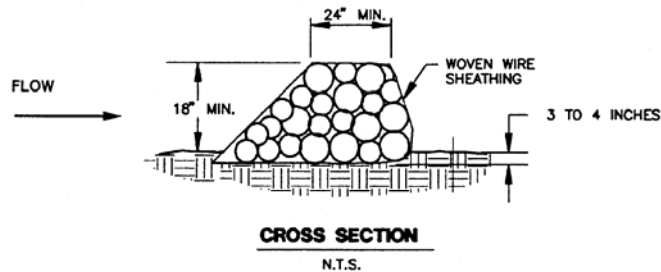

Rock Berm Spacing on Channels

Ditch slope	Spacing
30%	10 ft.
20%	15 ft.
15%	20 ft.
10%	35 ft.
5%	55 ft.
3%	100 ft.
2%	150 ft.
1%	300 ft.
0.50%	600 ft.

(applies for rock berms, high service rock berms, brush berms, and fiber rolls)

Schematic Diagram of a Rock Berm

Brush Berms

The purpose of a brush berm is to intercept and detain water-borne sediment from unprotected areas of a limited extent (maximum contributing drainage area of 2 acres).

Notes:

1. Use woody brush and branches, like juniper (cedar) less than 2 inches in diameter.
2. Hand place brush limbs following a constant contour with the vegetated part of the limb in close contact with the ground, overlapping with the previous branch to provide a shingle effect.
3. Construct the berm in lifts with each layer extending the entire length of the berm until the next layer is started.
4. Secure brush with ¼ inch polypropylene or nylon rope anchored with 3/8-inch diameter, 18-inch long rebar stakes.
5. The height of the brush berm should be a minimum of 24" after the securing ropes have been tightened.
6. Filter fabric may be required in higher velocity applications or in sensitive areas.
7. Inspect weekly and after each rain event (of 0.5 inch or more) to locate and repair any damage. Periodically tighten the anchoring ropes.
8. Remove sediment when buildup reaches 6 inches. Dispose of sediment in a manner that will not cause additional siltation.
9. When construction is complete, properly dispose of any sediment buildup and restore the prior location of the brush berm. Properly dispose of removed materials.

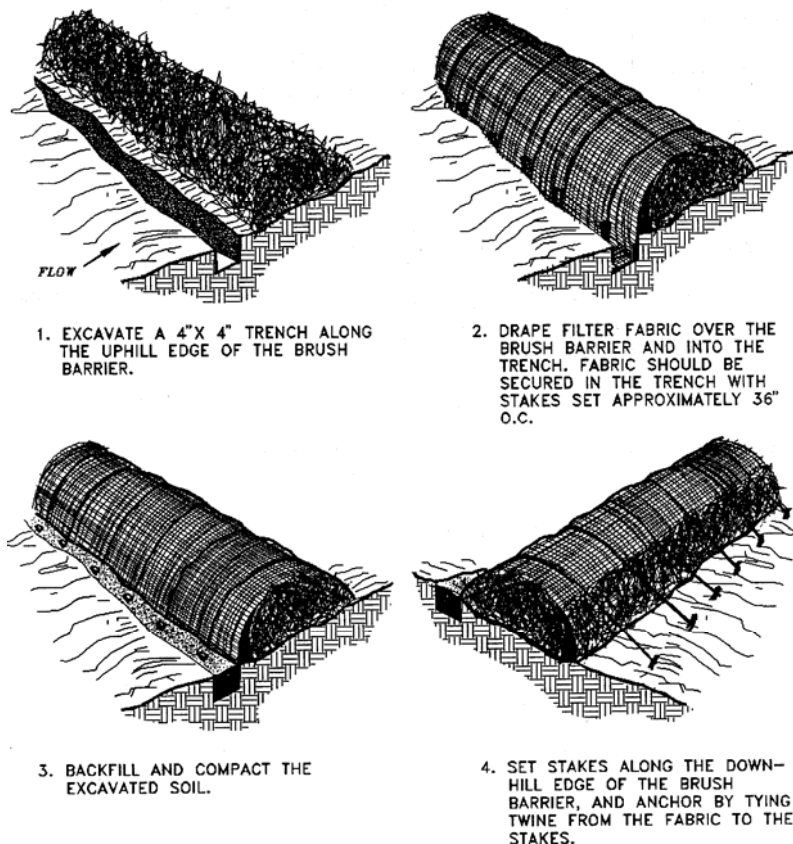

Schematic Diagram of a Brush Berm

Check Dams

Check dams are small barriers consisting of rock or earthen berms placed across a drainage swale or ditch. They reduce the velocity of small concentrated flows, provide a limited barrier for sediment and help disperse concentrated flows, reducing potential erosion.

Notes:

1. Use clean, coarse aggregate for smaller drainage areas; add open graded 3- to 5-inch diameter rock riprap for a more stable structure for larger drainage areas or steeper channels.
2. The dam height should be between 18 and 36 inches and should be keyed into the soil 6 inches.
3. The center of the check dam should be at least 6 inches lower than the outer edges to prevent scour at the ends of the dam.
4. The maximum spacing between the dams should be such that the toe of the upstream dam is at the same elevation as the top of the downstream dam.
5. Inspect weekly and after each rain event (of 0.5 inch or more) to locate and repair any damage.
6. Remove the sediment when it reaches one half of the original height of the check dam. Dispose of sediment in a manner that will not cause additional siltation.
7. When construction is complete, properly dispose of any sediment buildup and restore the prior location of the check dam.
8. Check dams should be removed when the site has been revegetated, but may be left in place as a permanent BMP where appropriate.

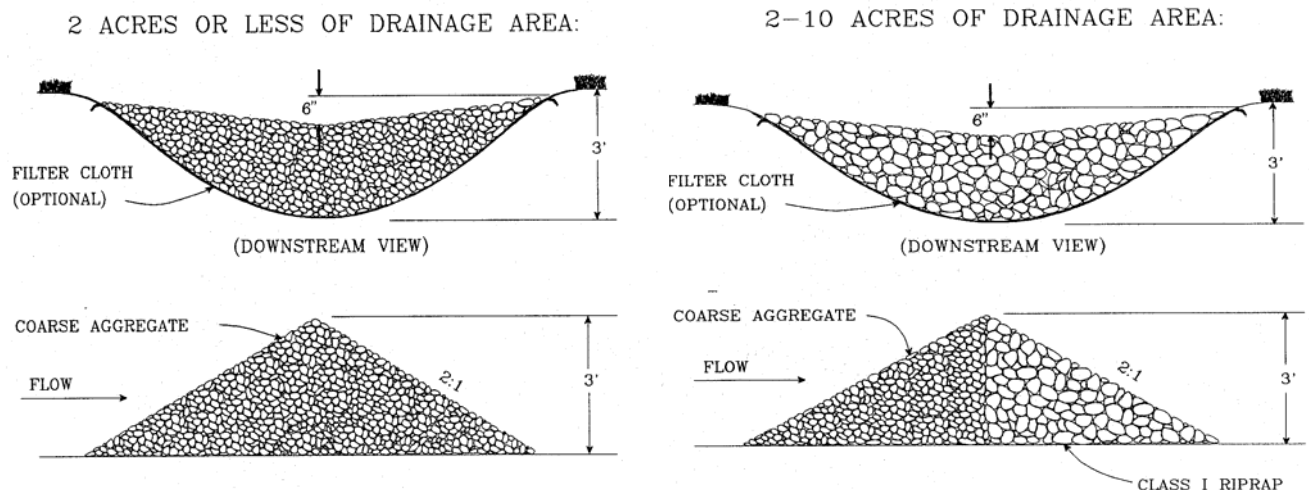

Schematic Diagrams of Rock Check Dams

Drop Inlet Protection

In developments for which drainage is to be conveyed by underground storm sewers (i.e., streets with curbs and gutters), all inlets that may receive storm runoff from disturbed areas should be protected. Care should be taken when choosing a specific type of inlet protection, so that excessive ponding in an area of high construction activity does not become so inconvenient that it is removed or bypassed. In such situations, a structure with an adequate overflow mechanism should be utilized.

It should also be noted that inlet protection devices are designed to be installed on construction sites and caution should be used when installed on streets and roads open to the public. When used on public streets these devices will cause ponding of runoff, which can cause flooding and can present a traffic hazard.

Notes:

1. Use a nonwoven filter fence with a minimum weight of 4.0 oz/yd².
2. Use 2" x 4" pressure treated wood stakes or galvanized steel, tubular in cross-section or standard fence "T" posts.
3. Wire mesh should be standard hardware cloth or comparable wire mesh with an opening size not to exceed 1/2 inch.
4. If the drop inlet is above the finished grade, the grate may be completely covered with filter fabric. The fabric should be securely attached to the entire perimeter of the inlet using 1"x 2" wood strips and appropriate fasteners.
5. Inspect frequently and replace the filter cloth and other materials when clogged with sediment. Dispose of sediment in a manner that will not cause additional siltation.
6. When construction is complete, properly dispose of any sediment buildup. The filter fabric materials should be disposed of in an approved landfill. Serviceable components may be salvaged for reuse.

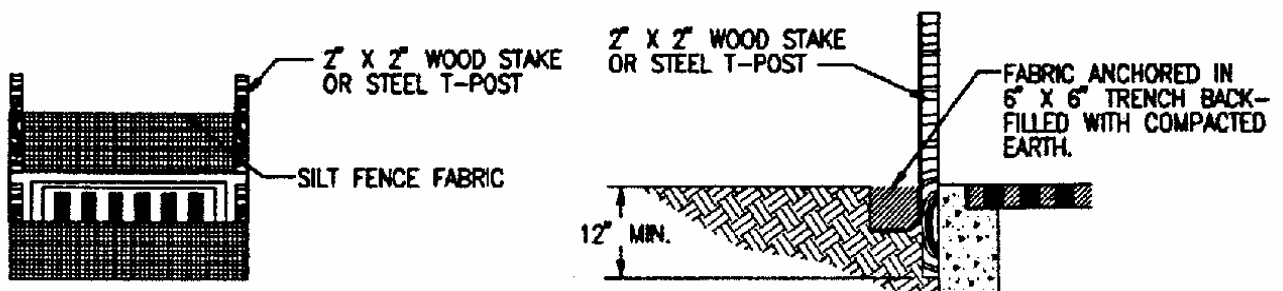

Silt Fence Drop Inlet Protection



**Lower Colorado River Authority
Watershed Management
Erosion and Sedimentation Control Details**

Curb Inlet Protection

In developments for which drainage is to be conveyed by underground storm sewers (i.e., streets with curbs and gutters), all inlets that may receive storm runoff from disturbed areas should be protected. Care should be taken when choosing a specific type of inlet protection, so that excessive ponding in an area of high construction activity does not become so inconvenient that it is removed or bypassed. In such situations, a structure with an adequate overflow mechanism should be utilized.

It should also be noted that inlet protection devices are designed to be installed on construction sites and caution should be used when installed on streets and roads open to the public. When used on public streets these devices will cause ponding of runoff, which can cause flooding and can present a traffic hazard.

Notes:

1. Attach a continuous piece of wire mesh (30-inch minimum width x inlet throat length plus 4 feet) to the 2-inch x 4-inch wooden weir (with a total length of throat length plus 2 feet). Wood should be "construction grade" lumber.
2. Place a piece of nonwoven filter fence with a minimum weight of 4.0 oz/yd² of the same dimensions as the wire mesh over the wire mesh and securely attach to the 2-inch x 4-inch weir.
3. Securely nail the 2-inch x 4-inch weir to the 9-inch long vertical spacers which are to be located between the weir and inlet face at a maximum 6-foot spacing.
4. Place the assembly against the inlet throat and nail 2-foot (minimum) lengths of 2-inch x 4-inch board to the top of the weir at spacer locations. These 2-inch x 4-inch anchors should extend across the inlet tops and be held in place by sandbags or alternate weight.
5. The assembly should be placed so that the end spacers are a minimum 1 foot beyond both ends of the throat opening.
6. Form the wire mesh and filter cloth to the concrete gutter and against the face of curb on both sides of the inlet. Place coarse aggregate or sandbags over the wire mesh and filter fabric in such a manner as to prevent water from entering the inlet under or around the filter cloth.
7. The sand bag material should be polypropylene, polyethylene, polyamide or cotton burlap woven fabric, minimum unit weight 4 oz/yd², length of 24 to 30 inches, width of 16 to 18 inches and thickness of 6 to 8 inches. Sandbags should be filled with coarse grade sand, free from deleterious material. The filled bag should have an approximate weight of 40 pounds and stapled or tied with nylon or poly cord.
8. Assure that storm flow does not bypass inlet by installing temporary earth or asphalt dikes directing flow into inlet.
9. Inspect frequently and replace the filter cloth and other materials when clogged with sediment. Dispose of sediment in a manner that will not cause additional siltation. Replace any torn fabric and repair any sections crushed or collapsed in the course of construction activity.
10. When construction is complete, properly dispose of any sediment buildup. The filter fabric materials should be disposed of in an approved landfill. Serviceable components may be salvaged for reuse.

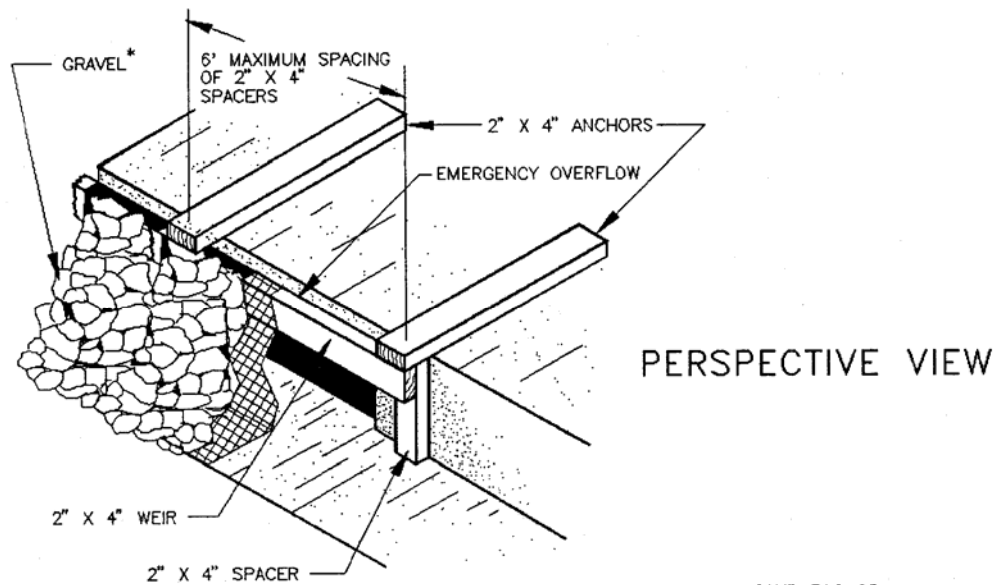

SIDE ELEVATION

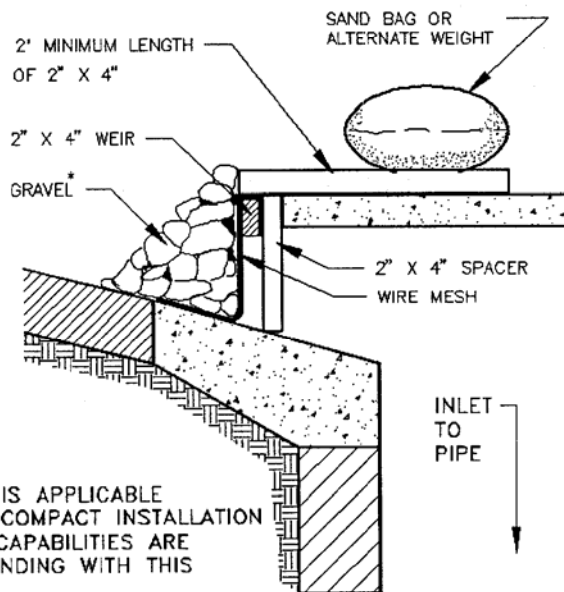

SPECIFIC APPLICATION

THIS METHOD OF INLET PROTECTION IS APPLICABLE TO CURB INLETS WHERE A STURDY, COMPACT INSTALLATION IS DESIRED. EMERGENCY OVERFLOW CAPABILITIES ARE MINIMAL, SO EXPECT SIGNIFICANT PONDING WITH THIS MEASURE.

*sandbags may be used instead of loose gravel

Wooden Weir Curb Inlet Protection

Creek Crossings

Creek crossings represent particularly important areas to employ effective erosion and sedimentation control. Underground utility construction and road construction across creeks requires special measures, as detailed below. **Refer to the Silt Fence and Rock Berm Handouts for details of these items.**

Notes:

1. Creek crossings should be made perpendicular to the creek flowline.
2. Schedule work when a time period of dry weather sufficient to complete the work is forecast.
3. Dewater or divert flow prior to commencing work within creek channels. Contact LCRA for inspection of dewatering/diversion system prior to commencing work.
4. Before any trenching or excavation, install two high service rock berms (rock berm with silt fence in the middle) at 100-ft spacing across the channel (perpendicular to the flowline) downstream of the proposed trench. These berms should be located between 100 and 300 feet downstream of the proposed trench. Lay pipe or other utility line and bury as soon as possible after trenching.
5. After installation is complete (or at the end of work day, if installation cannot be completed by end of day), install silt fencing along trench line on either side of creek at 25-ft intervals.
6. Excavated materials should be hauled out of the channel or used in backfill of open trench. No loose excavated material should be left in the channel at the end of a work day.
7. Remove all loose excavated material to a secure location outside the creek channel and suspend further construction in the creek area if rainfall threatens.
8. A concrete cap should be placed over buried pipe within the creek, and the streambed should be restored to proper grade.
9. Revegetate the disturbed area using appropriate native or adapted grass species incorporated with erosion blankets/matting.

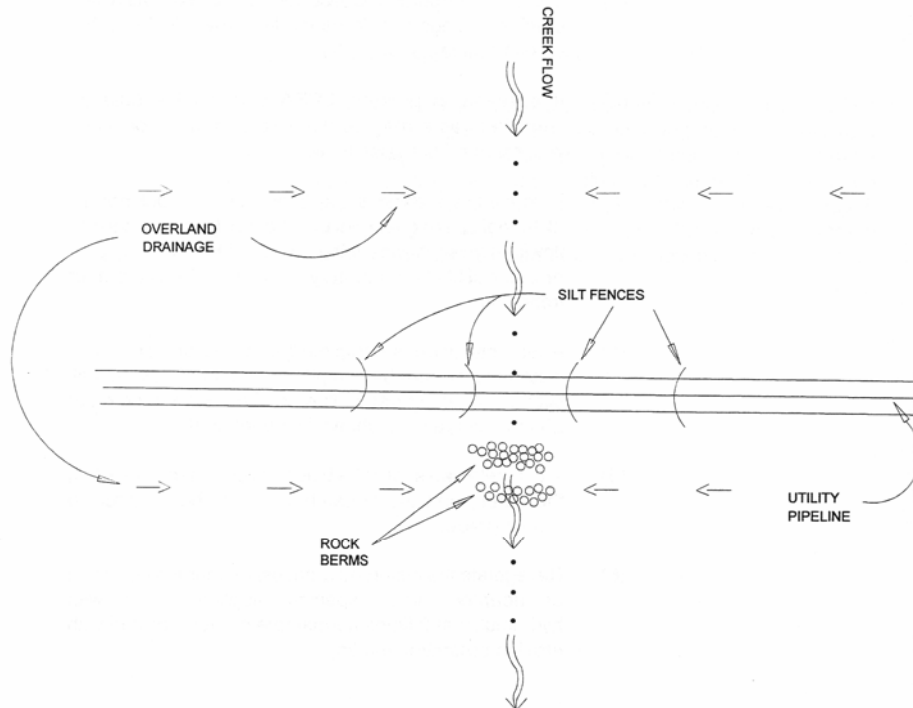

Utility Crossing or Excavation within Creek

Concrete Washout Areas

The purpose of concrete washout areas is to prevent or reduce the discharge of pollutants to stormwater from concrete waste by conducting washout offsite, performing onsite washout in a designated area, and training employees and subcontractors.

Notes:

1. Avoid mixing excess amounts of fresh concrete.
2. Perform washout of concrete trucks in designated areas only.
3. Construct washout area using 10 mil plastic lining and anchor the lining with sandbags or rocks.
4. Locate washout area at least 50 feet from sensitive features, storm drains, open ditches, or water bodies. **Do not allow runoff from this area - construct a temporary pit or bermed area large enough to contain both liquid and solid waste.**
5. Wash out wastes into the temporary pit where the concrete can set, be broken up, and then disposed properly, along with the lining.
6. Holes, depressions or other ground disturbance caused by the removal of the temporary concrete washout facilities should be backfilled, repaired, and revegetated or otherwise stabilized.

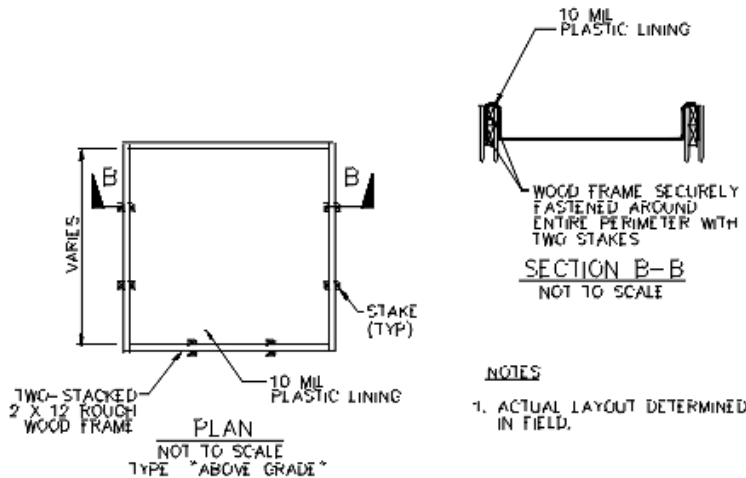
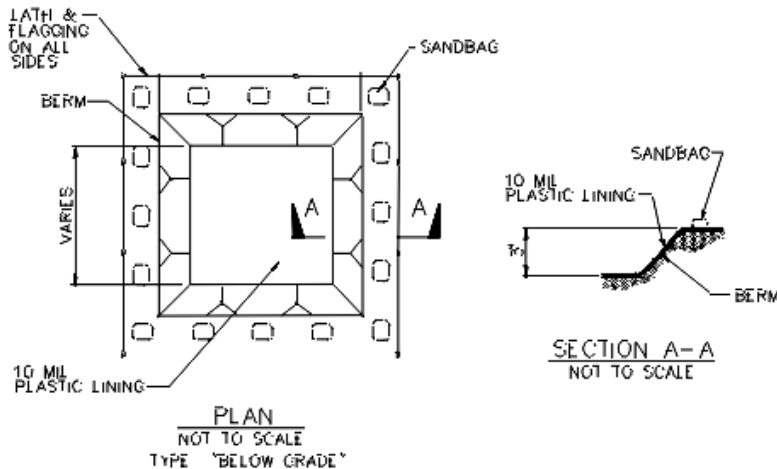

Schematics of Concrete Washout Areas

Erosion/Sedimentation Control General Notes

1. The Contractor shall install erosion/sedimentation controls prior to any site preparation work (clearing, grubbing or excavation).
2. The placement of erosion/sedimentation controls shall be in accordance with the LCRA Water Quality Management Technical Manual and the approved Erosion and Sedimentation Control Plan.
3. A pre-construction conference shall be held on-site with the Contractor, Design Engineer/Permit Applicant and LCRA Watershed Management Inspector after installation of the erosion/sedimentation controls and prior to beginning any site preparation work. The Contractor shall notify the LCRA Inspector, at least three days prior to the meeting date.
4. Any major variation in materials or locations of controls or fences from those shown on the approved plans will require a revision and must be approved by the LCRA Watershed Management Program. Minor changes to be made as field revisions to the Erosion and Sedimentation Control Plan may be required by the LCRA Watershed Management Inspector during the course of construction to correct control inadequacies.
5. The Contractor is required to inspect the controls and fences at weekly intervals and after rainfall events in excess of 0.5" to insure that they are functioning properly. The person(s) responsible for maintenance of controls and fences shall immediately make any necessary repairs to damaged areas. Silt accumulation at controls must be removed when the depth reaches six (6) inches.
6. Prior to final acceptance by the LCRA, haul roads and waterway crossings constructed for temporary contractor access must be removed, accumulated sediment removed from the waterway and the area restored to the original grade and revegetated. All land clearing debris shall be disposed of in approved spoil disposal sites.
7. Permanent Erosion Control: All disturbed areas shall be restored as noted below.
 - A. A minimum of four inches of topsoil shall be placed on all disturbed areas (except rock outcrop). Salvaged topsoil from the site should be used whenever possible. Imported topsoil shall be weed free with a minimum 20% organic content. Topsoil placed on slopes exceeding 5 horizontal to 1 vertical shall have a relatively high resistivity to erosion.
 - B. The seeding for permanent erosion control shall be applied over areas disturbed by construction as follows (select one of the three seed combinations listed below):

Dates	Climate	Species (lb/ac)	
Year Round	Permanent Cool/Warm Season (Native Species)	Purple three-awn (<i>Aristida purpurea</i>)	1.4
		Sideoats grama (<i>Bouteloua curtipendula</i>)	2.0
		Silver bluestem (<i>Bothriochloa laguroides</i>)	6.0
		Buffalograss (<i>Buchloe dactyloides</i>)	1.4
		Canadian wildrye (<i>Elymus Canadensis</i>)	1.4
		Engelmann's daisy (<i>Engelmannia pinnatifida</i>)	0.6
		Green sprangletop (<i>Leptochloa dubia</i>)	2.6
		Mexican hat (<i>Ratibida columnifera</i>)	1.0
		Little bluestem (<i>Schizachyrium scoparium</i>)	1.8
		Indiangrass (<i>Sorghastrum nutans</i>)	1.8
		<u>Texas Wintergrass (<i>Nassella leucotricha</i>)</u>	<u>15.0</u>
		Total	35.0
Mar 30-Oct 1	Permanent Warm Season	Bermuda (<i>Cynodon dactylon</i>)(hulled)	45.0

Oct 1-Mar 30	Permanent Cool/Warm Season	Bermuda (Cynodon dactylon)(unhulled) *Cereal Rye (Secale cereale)	70.0 90.0
		Total	160.0

Take care to distribute seed evenly, by sowing fine and large seeds separately or by using a fine seed box. When broadcasting seeding, the application rate should be doubled and the area rolled to ensure a good seed/soil contact

*From September 15 to March 1, Oats (21 lb/acre) and Winter Wheat (30 lb/acre) may be substituted for Rye.

Mulch type used shall be hay, straw or mulch applied at a rate of 3500 lb/acre (hay), 4500 lb/acre (straw) or 2500 lb/acre (hydraulic mulch). Tackifier, if used shall be biodegradable.

C. The planted area shall be irrigated or sprinkled in a manner that will not erode the topsoil, but will sufficiently soak the soil to a depth of six inches. The irrigation shall occur at ten-day intervals during the first two months. Rainfall occurrences of ½ inch or more shall postpone the watering schedule for one week.

D. Restoration shall be acceptable when the grass has grown at least 1½ inches high with 70% coverage, provided no bare spots larger than 16 square feet exist. Critical areas including creek crossings, slopes, stormwater discharge points must be completely stabilized. Permanent Water quality BMPs must attain 80% coverage.

8. Developer Information:

Owner _____ Phone # _____

Address _____

Owner's representative responsible for plan alterations:

_____ Phone # _____

Person or firm responsible for erosion/sedimentation control maintenance:

_____ Phone # _____

Person or firm responsible for tree/natural area protection Maintenance:

_____ Phone # _____

9. The contractor shall not dispose of surplus excavated material from the site without notifying the LCRA Watershed Management Inspector at least 48 hours prior with the location and a copy of the permit issued to receive the material.

Notes for Construction in Creeks

Schedule work when a minimum of (include a sufficient time period to complete the work) days of dry weather are forecast. Dewater or divert flow prior to commencing work within creek channels. Contact LCRA for inspection of dewatering/diversion system prior to commencing work.

No loose excavated material shall be left in the creek at the end of the work day.

Remove all loose excavated material to a secure location outside the creek channel and suspend further construction in the creek area if rainfall threatens.

Site Characteristics for High Erosion Potential

- Disturbed Area > (5) acres
- More than 25% of site has slopes > 10 %
- Soils – silts/clays from SCS Soil Surveys
- Existing Vegetative Cover < 50 % coverage (groundcover)
- Off-site Drainage Area > 5 acres (discharges to site)
- Construction Duration > six months
- Road crossing(s) of drainage ways/buffer zones
- Distance of soil disturbance from creek centerline is less than 100 feet

If a development project is within different drainage areas or has more than one discharge point, then the above rating is applied to each drainage area/discharge point.

**A project has a High Erosion Potential IF:
Four or more items are checked in Table 2-12**

Primary Type of Construction

- Site or Building/Parking
- Streets/Drainage (Subdivision)
- Homebuilding
- Utility
- Maintenance
- Road (CIP)
- Other

Appendix 2.9

Water Quality Education

Proper handling, use, and disposal of fertilizers and pesticides. Controlling the rate, timing, and method of chemical applications can minimize use and limit runoff contamination in a watershed. LCRA provides educational materials on the proper type and amount of fertilizers needed for a particular landscape in the Grow Green program. The U.S. Department of Agriculture and other agencies provide fertilizer and pesticide management guidance in selecting the most environmentally safe chemical and minimum effective dosage. In addition, LCRA, the City of Austin, and the TCEQ operate household hazardous waste collection programs for the disposal of household chemicals such as pesticides.

Proper handling, use, and disposal of household chemicals. A wide variety of cleansers, oils, solvents, paints, and other household materials pose certain risks to the environment. Some wastes are legally defined as hazardous or toxic and must be disposed of using stringent procedures imposed by federal, state, or local laws. Citizens need to know how to safely use and dispose of many household materials including antifreeze, gasoline, waste motor oil, car batteries, old tires, floor or furniture polish, most cleaning products, chlorine bleach, paints, paint thinners, turpentine, mineral spirits, wood preservatives, weed killers, and roach and ant killers.

Proper solid waste management. Historically, efforts to control the accumulation of litter were focused on health and aesthetic concerns. In recent years, the impact of this debris on stormwater quality and stormwater management system maintenance has become an equal, if not greater, concern. Solid wastes and litter that accumulate on the land are easily transported by runoff. An effective litter and debris control program should include source controls as well as debris removal and disposal. Appropriate placement of waste receptacles should be considered during the project design phase. Regularly scheduled maintenance of these receptacles and signage (such as for pet waste or litter pickup) can encourage their use.

Proper disposal of pet wastes. The wastes our pets leave behind can be a significant source of bacterial loading to our waters. Pet owners should collect and properly dispose of animal wastes to help reduce these loads and keep our waters open to recreation.

Recycling used waste oil. Many gallons of waste oil are dumped into storm sewers for disposal. However, this oil can be recycled and used for many activities. Many states, local governments, and private companies have established used-oil recycling programs and centers. In addition, most automobile oil change businesses will accept waste oil from the public.

Composting. As laws limiting the landfill disposal of yard wastes become more common, the proper management of grass, leaves, pruned branches, and other debris becomes increasingly important. Composting by homeowners or at collection centers reduces organic debris and associated pollutants from the runoff waste stream. Additional benefits include increased soil organic matter, resulting in improved water and nutrient holding capacity, and nutrients, which reduce the need for fertilizers.

Roofing or otherwise enclosing areas. Loading docks, storage areas for raw materials, wastes or final products, and equipment maintenance and storage areas are likely pollutant sources carried in runoff. Roofing or enclosing these areas so they are no longer exposed to rainfall or runoff

will prevent oil, gasoline, fuels, solvents, hydraulic fluids, sediment, organics, nutrients, and other pollutants from entering runoff.

Septic Systems. In developing a site for a septic system it is important for homeowners and builders to have a comprehensive plan for the property. By working together with the on-site sewage system designer and installer, the designer will be able to properly site the system to make it esthetically pleasing as well as safe. For detailed information on septic system permitting the owner should contact the local county office or LCRA if the site is within 22000 feet of the Highland Lakes normal pool elevation. Please refer to the LCRA website (www.lcra.org) for additional information. Committing attention to the care of the septic system is the best way to avoid a failing system. Listed below are some general maintenance tips for proper septic system care:

- Pump the septic tank regularly and check for leaks and cracks,
- Keep the septic tank cover accessible for tank inspections and pumping,
- Compost garbage,
- Do not dump solvents, oils, paints, thinners, disinfectants, pesticides, or poisons, down the drain which can disrupt the treatment process and contaminate the water supply,
- Only discharge biodegradable wastes into system,
- Do not drive vehicles over the drain-field or compact the soil in any way, and
- Call a professional when the system has problems

LCRA has stormwater education materials and “Grow Green” fact sheets available for builders and homeowners that are practical and easy to read. This information can aid in choosing the least toxic alternatives to lawn and garden care. A packet of this information can be given to all new homebuyers at the time purchase. You may contact LCRA’s Water Resource Protection to obtain education materials. 1-800-776-5272 Ext. 3597.

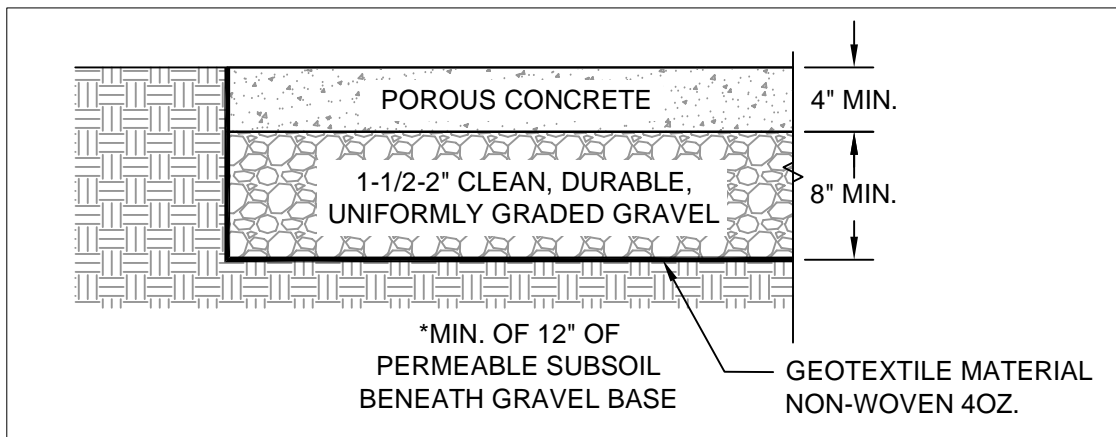

MATERIALS:

- i. **CEMENT:** PORTLAND CEMENT TYPE I OR II CONFORMING TO ASTM C 150 OR PORTLAND CEMENT TYPE IP OR IS CONFORMING TO ASTM C 595;
- ii. **AGGREGATE:** USE TEXAS DEPARTMENT OF TRANSPORTATION (TxDOT) GRADE NO.8 COARSE AGGREGATE (3/8 TO NO.16) PER ASTM C 33; OR NO.89 COARSE AGGREGATE (3/8 TO NO.50) PER ASTM D 448;
- iii. **ADMIXTURES:** OPTIONAL;
- iv. **WATER:** POTABLE OR SHOULD COMPLY WITH TxDOT STANDARD SPECIFICATIONS; AND
- v. **GEOTEXTILE FABRIC:** NON-WOVEN 4OZ.

PROPORTIONS:

- i. **CEMENT CONTENT:** FOR PAVEMENT SUBJECT TO VEHICULAR TRAFFIC LOADING, THE TOTAL CEMENTITIOUS MATERIAL SHALL BE NO LESS THAN 564 LBS. PER CUBIC YARD;
- ii. **AGGREGATE CONTENT:** THE VOLUME OF AGGREGATE PER CUBIC YARD SHALL BE EQUAL TO 27 CUBIC FEET WHEN CALCULATED AS A FUNCTION OF THE UNIT WEIGHT DETERMINED IN ACCORDANCE WITH ASTM C 29 JIGGING PROCEDURE;
- iii. **ADMIXTURE:** OPTIONAL FOR STRENGTH; AND
- iv. **MIX WATER:** MIX WATER QUANTITY SHALL BE SUCH THAT THE CEMENT PASTE DISPLAYS A WET METALLIC SHEEN WITHOUT CAUSING THE PASTE TO FLOW FROM THE AGGREGATE. (MIX WATER QUANTITY YIELDING A CEMENT PASTE WITH A DULL-DRY APPEARANCE HAS INSUFFICIENT WATER FOR HYDRATION.)

INSUFFICIENT WATER RESULTS IN INCONSISTENCY IN THE MIX AND POOR AGGREGATE BOND STRENGTH. HIGH WATER CONTENT RESULTS IN THE PASTE SEALING THE VOID SYSTEM PRIMARILY AT THE BOTTOM AND POOR AGGREGATE SURFACE BOND.

GENERAL REQUIREMENTS:

- i. **DRIVEWAY SLOPE** MUST BE LESS THAN 2%;
- ii. **SUBSOIL:** 12" OF SUITABLE SUBSOIL IN TERMS OF SUPPORT AND INFILTRATION REQUIRED. A MINIMUM INFILTRATION RATE OF 0.52 IN/HR IS REQUIRED. SOILS WITH AN INFILTRATION RATE BETWEEN 0.27 AND 0.52 IN/HR HAVE MARGINAL INFILTRATION CAPACITY AND MAY NOT BE SUITABLE FOR ABSORBING RUNOFF. SAND, LOAMY SAND, AND SANDY LOAM ARE GENERALLY CONSIDERED SUITABLE FOR INFILTRATION AND SUPPORT.

INSTALLATION

- i. **SUBGRADE:** THE SUBGRADE MUST NOT BE COMPACTED OR SUBJECTED TO CONSTRUCTION VEHICLE TRAFFIC OR SEDIMENT PRIOR TO THE PLACEMENT OF BASE. SUBGRADE WORK MUST BE SEQUENCED TO MINIMIZE PASSES OF CONSTRUCTION VEHICLES IN THE BEDS THEMSELVES. IF THE EXCAVATED SUBGRADE IS EXPOSED TO RAINFALL RUNOFF, IT MAY ACCUMULATE FINES. GRADING SHOULD NOT OCCUR DURING WET SOIL CONDITIONS TO MINIMIZE SMEARING AND SEALING OF THE SOIL SURFACE. IF SUCH SEALING OCCURS, THE SURFACE MUST BE SCARIFIED TO RESTORE NATURAL TEXTURE AND PERMEABILITY;
- ii. **GEOTEXTILE FABRIC:** A LAYER OF NON-WOVEN 4OZ. GEOTEXTILE FABRIC IS TO BE PLACED ON TOP OF THE NATURAL SUBSOIL PRIOR TO PLACING BASE MATERIAL. THE FABRIC SHOULD EXTEND UP TO THE NATURAL EARTH SIDES AND OVER THE TOP OF ANY ADJACENT BERM. THE PURPOSE OF THE FABRIC IS TO PREVENT MIGRATION OF FINE MATERIAL FROM THE SUBSOIL INTO THE GRAVEL;
- iii. **BASE MATERIAL:** THE BASE MATERIAL SHOULD BE COMPACTED TO A THICKNESS OF 8" WITH A STATIC ROLLER RATHER THAN A VIBRATORY ROLLER;
- iv. **POROUS CONCRETE:** USE CERTIFIED POROUS CONCRETE INSTALLER FOR INSTALLATION.

MAINTENANCE

- i. SUBJECT TO ANNUAL INSPECTIONS BY LCRA OR PROPERTY ASSOCIATION; AND
- ii. VACUUMING AND POWER WASHING PER MANUFACTURE'S SPECIFICATIONS.

<p>LOWER COLORADO RIVER AUTHORITY</p>	<p>DATE: 05-2007</p>	<p>SHEET: 1 OF 1</p>
<p>POROUS CONCRETE FOR RESIDENTIAL DRIVEWAY DETAIL</p>		

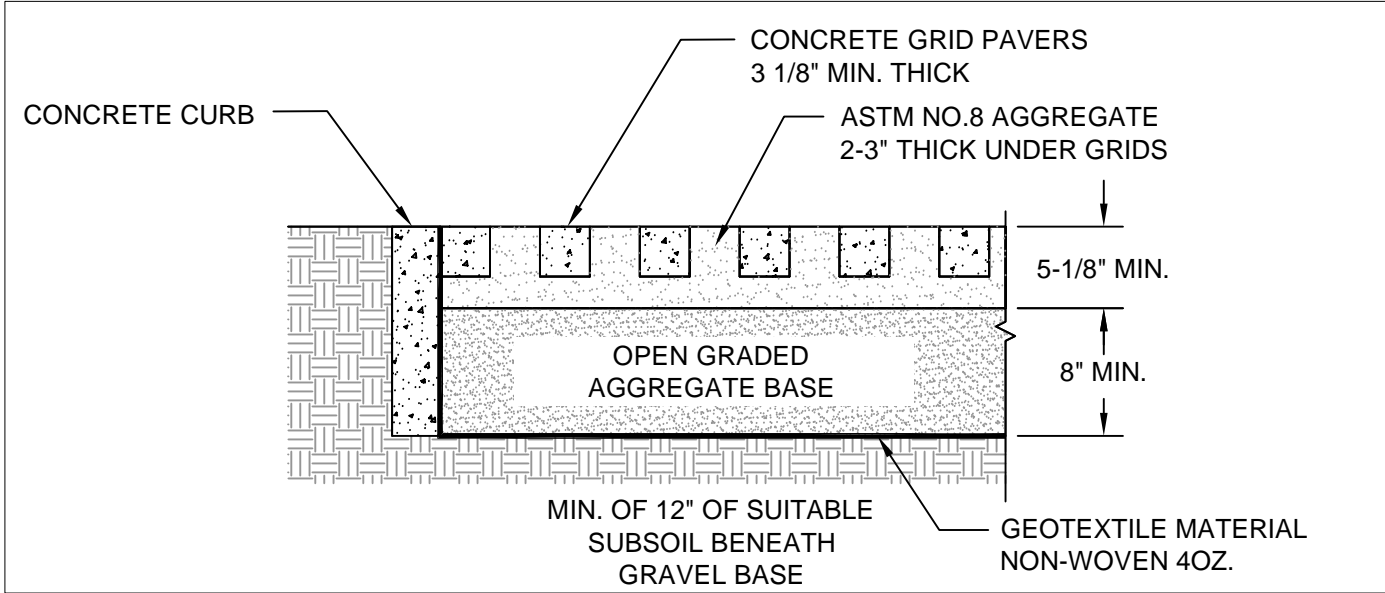

MATERIALS:

- i. GEOTEXTILE MATERIAL: NON-WOVEN 4 OZ;
- ii. OPEN-GRADED AGGREGATE BASE: VOID SPACE BETWEEN 30-40%. ASTM NO.57 CRUSHED STONE AGGREGATE IS SUITABLE AS A BASE AND STORAGE MEDIUM FOR RUNOFF;
- iii. RECEIVING AGGREGATE: ASTM NO.8 AGGREGATE; AND
- iv. CONCRETE GRID PAVERS: ASTM C 1319, STANDARD SPECIFICATION FOR CONCRETE GRID PAVING UNITS.

GENERAL REQUIREMENTS:

- i. DRIVEWAY SLOPE MUST BE LESS THAN 2%;
- ii. SUBSOIL: 12" OF SUITABLE SUBSOIL IN TERMS OF SUPPORT AND INFILTRATION REQUIRED. A MINIMUM INFILTRATION RATE OF 0.52 IN/HR IS REQUIRED. SOILS WITH AN INFILTRATION RATE BETWEEN 0.27 AND 0.52 IN/HR HAVE MARGINAL INFILTRATION CAPACITY AND MAY NOT BE SUITABLE FOR ABSORBING RUNOFF. SAND, LOAMY SAND, AND SANDY LOAM ARE GENERALLY CONSIDERED SUITABLE FOR INFILTRATION AND SUPPORT.

INSTALLATION:

- i. SUBGRADE: THE SUBGRADE MUST NOT BE COMPACTED OR SUBJECTED TO CONSTRUCTION VEHICLE TRAFFIC OR SEDIMENT PRIOR TO THE PLACEMENT OF BASE. SUBGRADE WORK MUST BE SEQUENCED TO MINIMIZE PASSES OF CONSTRUCTION VEHICLES IN THE BEDS THEMSELVES. IF THE EXCAVATED SUBGRADE IS EXPOSED TO RAINFALL RUNOFF, IT MAY ACCUMULATE FINES. GRADING SHOULD NOT OCCUR DURING WET SOIL CONDITIONS TO MINIMIZE SMEARING AND SEALING OF THE SOIL SURFACE. IF SUCH SEALING OCCURS, THE SURFACE MUST BE SCARIFIED TO RESTORE NATURAL TEXTURE AND PERMEABILITY;
- ii. GEOTEXTILE FABRIC: A LAYER OF NON-WOVEN 4OZ. GEOTEXTILE FABRIC IS TO BE PLACED ON TOP OF THE NATURAL SUBSOIL PRIOR TO PLACING BASE MATERIAL. THE FABRIC SHOULD EXTEND UP TO THE NATURAL EARTH SIDES AND OVER THE TOP OF ANY ADJACENT BERM. THE PURPOSE OF THE FABRIC IS TO PREVENT MIGRATION OF FINE MATERIAL FROM THE SUBSOIL INTO THE GRAVEL;
- iii. BASE MATERIAL: THE BASE MATERIAL SHOULD BE COMPACTED TO A THICKNESS OF 8" WITH A STATIC ROLLER RATHER THAN A VIBRATORY ROLLER AND THEN CHOKED WITH A 2-3" THICK LAYER OF ASTM NO.8 CRUSHED STONE. THIS LAYER SHOULD BE ROLLED LEVEL AS WELL, AND A THIN, LOOSE LAYER OF NO.8 STONE SCREEDED EVENLY ACROSS THE SURFACE TO RECEIVE THE PAVING UNITS; AND
- iv. CONCRETE GRID PAVERS: THE GRIDS ARE PLACED AND COMPACTED INTO THE LOOSE SURFACE OF THE NO.8 MATERIAL. THE OPENINGS ARE THEN FILLED WITH THE NO.8 MATERIAL AND THE PAVING UNITS ARE COMPACTED AGAIN. ADDITIONAL MANUFACTURE'S REQUIREMENTS MAY APPLY.

MAINTENANCE

- i. SUBJECT TO ANNUAL INSPECTIONS BY LCRA OR PROPERTY ASSOCIATION.

LOWER COLORADO RIVER AUTHORITY	DATE: 05-2007	SHEET: 1 OF 1
PERMEABLE PAVERS FOR RESIDENTIAL DRIVEWAY DETAIL		

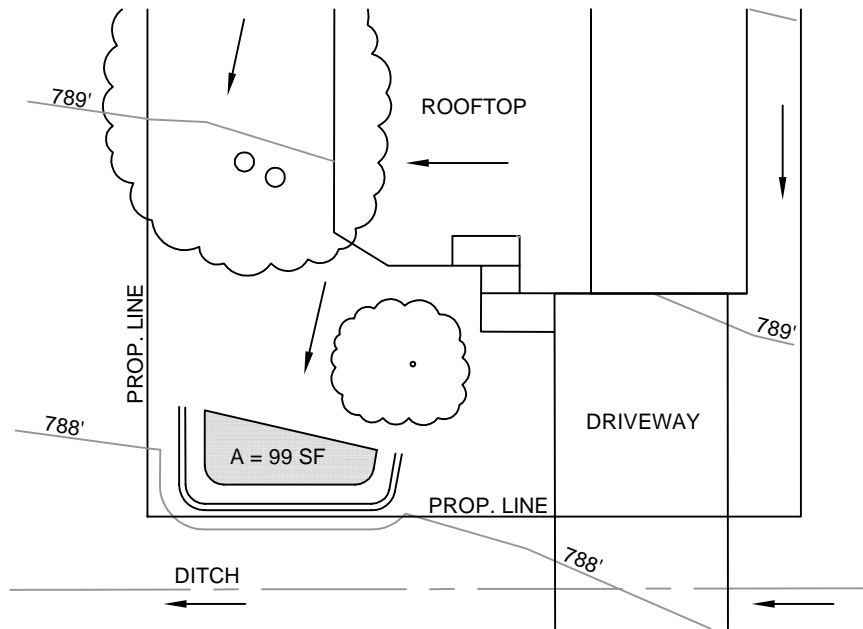

RAIN GARDEN SCHEMATIC

SIZING:

RAIN GARDEN BOTTOM AREA = VOLUME REQUIRED / DEPTH

VOLUME REQUIRED (CF) = SPECIFIED PER DEED RESTRICTIONS OR FOR SUDIVISIONS WITH IMPERVIOUS COVER LIMITS FOR INDIVIDUAL LOTS USE STORMWATER CREDIT WORKSHEET TO SIZE GARDEN

DEPTH = 0.33' - 0.67' (4"-8")

EXAMPLE: A RAIN GARDEN VOLUME OF 62 CUBIC FEET IS REQUIRED. A DEPTH OF 8" WILL BE USED TO MINIMIZE GARDEN'S FOOTPRINT. THE REQUIRED RAIN GARDEN BOTTOM AREA WOULD BE CALCULATED AS FOLLOWS: AREA = $62 / 0.67 = 92.5$ SF OR (16' LONG X 6' WIDE)

SITING:

- 1) RAIN GARDENS SHOULD BE PLACED TO MAXIMIZE CAPTURE OF RUNOFF FROM LOT INCLUDING LANDSCAPED AREAS;
- 2) SUNNY OR PARTLY SUNNY LOCATIONS ARE BEST FOR RAIN GARDENS, BUT SHADE GARDENS ARE POSSIBLE;
- 3) RAIN GARDENS SHOULD NOT BE PLACED WITHIN 10 FEET FROM RESIDENTIAL STRUCTURES;
- 4) RAIN GARDENS SHOULD NOT BE PLACED IN AREAS WITH EXISTING SLOPES OVER 12%;
- 5) RAIN GARDENS SHOULD NOT BE PLACED UNDER LARGE TREES. TREES HAVE EXTENSIVE ROOT SYSTEMS MAY BE DAMAGED IN THE RAIN GARDEN EXCAVATION PROCESS. IN ADDITION, THEY MAY NOT BE ABLE TO ADAPT TO THE EXTRA MOISTURE BEING HELD BY THE RAIN GARDEN;
- 6) RAIN GARDENS SHOULD NOT BE PLACED OVER OR NEAR THE DRAIN FIELD OF A SEPTIC SYSTEM;
- 7) RAIN GARDENS SHOULD NOT BE PLACED IN AREAS THAT ARE POORLY DRAINED OR COLLECT WATER. PLACE RAIN GARDENS UP-SLOPE OF THESE AREAS TO REDUCE THE AMOUNT OF WATER THAT FLOWS INTO THEM;
- 8) RAIN GARDENS SHOULD NOT BE PLACED WITHIN EXISTING DRAINAGE WAYS SUCH AS SWALES AND DITCHES;
- 9) RAIN GARDENS SHOULD NOT BE PLACED OVER UTILITY LINES. MAKE YOURSELF AWARE OF UNDERGROUND SERVICE LINES OR UTILITIES; AND
- 10) CHECK WITH YOUR LOCAL BUILDING DEPARTMENT BEFORE INSTALLING YOUR RAIN GARDEN TO AVOID CONFLICT WITH LOCAL ORDINANCES OR ZONING REGULATIONS.

LOWER COLORADO RIVER AUTHORITY

RAIN GARDEN DETAIL

DATE:
05-2007

SHEET:
1 OF 2

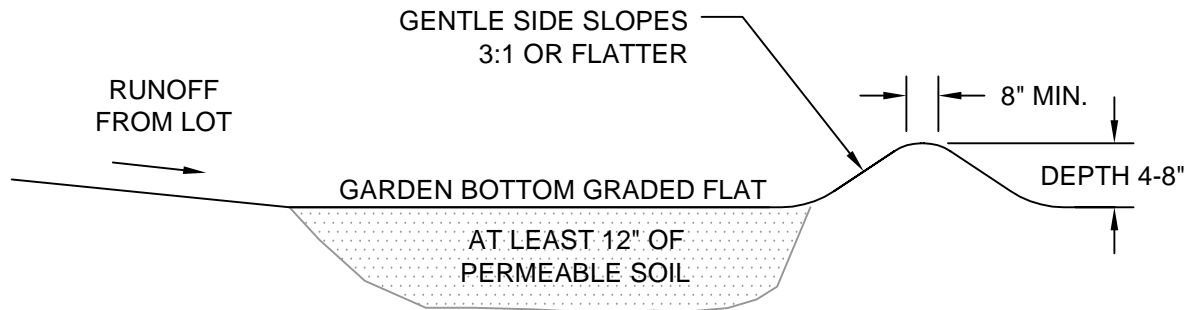

RAIN GARDEN CROSS-SECTION

GRADING:

- 1) RAIN GARDENS SHOULD BE BETWEEN 4"-8" IN DEPTH - SEE STORMWATER CREDIT WORKSHEET;
- 2) THE FLOOR OF THE RAIN GARDEN SHOULD BE GRADED AS FLAT AS POSSIBLE TO PERMIT UNIFORM PONDING AND INFILTRATION. LOW SPOTS AND DEPRESSIONS SHOULD BE LEVELED OUT; AND
- 3) BERMS SHOULD HAVE GENTLE SIDE SLOPES (3:1 OR FLATTER) SO THAT THE RAIN GARDEN SMOOTHLY INTEGRATES INTO THE SURROUNDING LAWN. RETAINING WALLS MAY BE USED AS APPROPRIATE.

INSTALLATION:

- 1) RAIN GARDENS SHOULD NOT BE CONSTRUCTED UNTIL THE UPSTREAM DRAINAGE AREA IS STABILIZED (REVEGETATED).

SOIL & PLANTINGS:

- 1) PLANTING NATIVE WILDFLOWERS, GRASSES AND SHRUBS ARE RECOMMENDED. ROOTS FROM NATIVE VEGETATION DO A GOOD JOB OF BREAKING UP CLAY SOILS AND INCREASING INFILTRATION EACH YEAR;
- 2) GARDEN DRAWDOWN: POND SHOULD DRAW DOWN FULL RAIN GARDEN WITHIN 24 HOURS. IF EXISTING SOILS DO NOT PROVIDE ADEQUATE INFILTRATION REPLACE WITH 12" OF IMPORT SOIL ; AND
- 3) IMPORT SOIL: RECOMMENDED SOIL MIX IS 30-40% SAND, 60-70% TOPSOIL. THE SOIL MIX SHOULD HAVE LESS THAN 5% CLAY WITH NO COMMERCIAL FERTILIZERS, MANURE OR SANDY LOAM. PROVIDE CLEAN SAND, FREE OF DELETERIOUS MATERIALS. THE SOIL MIX SHOULD BE FREE OF STONES, STUMPS, ROOTS, OR OTHER SIMILAR OBJECTS LARGER THAN TWO INCHES. TILL UNDERLYING NATIVE SOIL TO INCREASE INFILTRATION.

MAINTENANCE:

- 1) RAIN GARDENS ARE SUBJECT TO INSPECTION TWICE ANNUALLY AND ONCE DURING OR IMMEDIATELY FOLLOWINGS WET WEATHER;
- 2) BARE SPOTS AND AREAS OF EROSION INSIDE AND DOWNSTREAM OF GARDEN SHOULD BE REPAIRED OR REVEGETATED IMMEDIATELY;
- 3) SEDIMENT BUILDUP SHALL BE EVALUATED DURING INSPECTIONS AND REMOVED WHEN SEDIMENT ACCUMULATION EXCEEDS 1" IN DEPTH OR WHENEVER DRAWDOWN TIME IS EXCEEDED; AND
- 4) IDENTIFY AND PROMPTLY REPAIR ANY SUBSIDENCE, LEAKAGE, AND CRACKING ALONG GARDEN BERMS.

LOWER COLORADO RIVER AUTHORITY

RAIN GARDEN DETAIL

DATE:
05-2007

SHEET:
2 OF 2

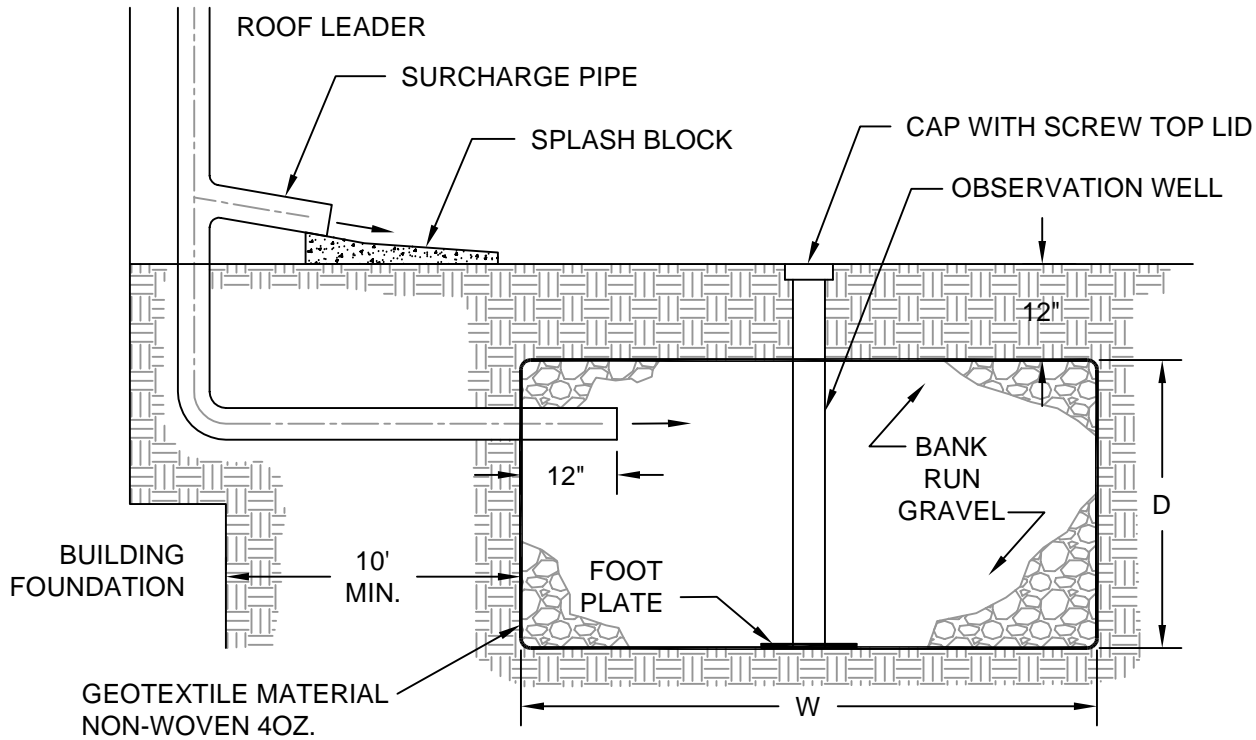

DRY WELL SIZING

$$L = V / (W \times D \times P)$$
 L = LENGTH (FT)
 V = VOLUME (CF)
 W = WIDTH (FT)
 D = DEPTH (FT)
 P = POROSITY = 0.35

EXAMPLE

62 CF OF STORAGE IN DRY VAULT REQUIRED
 DRY VAULT TO BE 3 FT DEEP BY 6 FT WIDE

$$L = 62 / (6 \times 3 \times 0.35) = 9.8 \text{ FT, SAY } 10 \text{ FT}$$

SEE STORMWATER CREDIT WORKSHEET

GENERAL REQUIREMENTS:

- i. MUST BE LOCATED MORE THAN 10' FROM FOUNDATIONS; AND
- ii. SUBSOIL: 12" OF SUITABLE SUBSOIL IN TERMS OF SUPPORT AND INFILTRATION REQUIRED. A MINIMUM INFILTRATION RATE OF 0.52 IN/HR IS REQUIRED. SOILS WITH AN INFILTRATION RATE BETWEEN 0.27 AND 0.52 IN/HR HAVE MARGINAL INFILTRATION CAPACITY AND MAY NOT BE SUITABLE FOR ABSORBING RUNOFF. SAND, LOAMY SAND, AND SANDY LOAM ARE GENERALLY CONSIDERED SUITABLE FOR INFILTRATION AND SUPPORT.

INSTALLATION:

- i. SUBGRADE: THE SUBGRADE MUST NOT BE COMPACTED OR SUBJECTED TO CONSTRUCTION VEHICLE TRAFFIC OR SEDIMENT PRIOR TO THE PLACEMENT OF GRAVEL. SUBGRADE WORK MUST BE SEQUENCED TO MINIMIZE PASSES OF CONSTRUCTION VEHICLES IN THE BEDS THEMSELVES. IF THE EXCAVATED SUBGRADE IS EXPOSED TO RAINFALL RUNOFF, IT MAY ACCUMULATE FINES. GRADING SHOULD NOT OCCUR DURING WET SOIL CONDITIONS TO MINIMIZE SMEARING AND SEALING OF THE SOIL SURFACE. IF SUCH SEALING OCCURS, THE SURFACE MUST BE SCARIFIED TO RESTORE NATURAL TEXTURE AND PERMEABILITY; AND
- ii. GEOTEXTILE FABRIC: A LAYER OF NON-WOVEN 4OZ. GEOTEXTILE FABRIC IS TO BE PLACED ON TOP OF THE NATURAL SUBSOIL PRIOR TO PLACING GRAVEL MATERIAL. THE FABRIC SHOULD WRAP THE ENTIRE GRAVEL BED THE PURPOSE OF THE FABRIC IS TO EXTEND THE LIFE OF THE DRY WELL BY PREVENTING MIGRATION OF FINE MATERIAL FROM THE SUBSOIL INTO THE GRAVEL BED.

MAINTENANCE

- i. SUBJECT TO ANNUAL INSPECTIONS BY LCRA OR PROPERTY ASSOCIATION; AND
- ii. REPLACE GRAVEL WHEN SEDIMENT ACCUMULATION EXCEEDS 50% OF DEPTH.

LOWER COLORADO RIVER AUTHORITY

DRY WELL DETAIL

DATE:
05-2007

SHEET:
1 OF 1

Appendix 2.10.4
Lower Colorado River Authority
Conservation Landscape Best Management Practices
(For Use in Ordinances or Deed Restrictions)
5/21/07

Irrigation System Specifications:

1. Landscape irrigation systems shall not be mandatory.
2. Landscape irrigation systems shall be installed by a licensed irrigator unless the homeowner is physically installing the system.
3. Irrigation systems shall be designed with:
 - a. a master valve with shut-off;
 - b. valves and circuits separated based on water use (hydro-zoned);
 - c. sprinkler heads spaced for head-to-head coverage, or heads spaced according to manufacturer's recommendations and adjusted for prevailing winds;
 - d. a benchmark distribution uniformity percentage of 0.6 or higher;
 - e. no run-off, with no direct over spray onto non-irrigated areas;
 - f. pop-up spray heads and rotors set back at least 6 inches from impervious surfaces;
 - g. no spray irrigation included on areas less than 6 feet in width;
 - h. an approved rain shut-off device set to shut off after 1/8" of rainfall;
 - i. pressure regulation components installed where dynamic pressure exceeds manufacturer's recommended operating range (30-60 psi); and
 - j. a controller capable of dual or multiple programming, with at least several start times for each irrigation program, a water budgeting feature and programmable to irrigate with a frequency of every one to ten days, and by day of week.
4. Installers must present the owner with a water budget that specifies:
 - a. estimated monthly water use in gallons per application;
 - b. total irrigated area in square feet;
 - c. precipitation rates for each valve circuit;
 - d. monthly irrigation schedule for the plant establishment period (first three months);

- e. the water utility recommended watering schedule (no more than twice per week), including seasonal adjustments, in a format that can be posted by the controller box;
 - f. location of emergency irrigation system shut-off valve; and
 - g. the distribution uniformity percentage for the system.
5. Spray irrigation for each home/business shall be limited to 2.5 times the foundation footprint, with a 12,000 sq foot maximum. The footprint may include both the house and the garage, but not the driveway or patio.
6. Irrigated landscaped common areas at entryways and intersections shall be limited such that:
- a. subdivision entryway landscaping shall not exceed 6000 square feet;
 - b. landscaping at intersections within the subdivision shall not exceed 3000 square feet.

Irrigation System Maintenance Specifications:

1. The developer, builder and/or homeowner associate shall make homeowners aware of the water utility recommended watering schedule.
2. Irrigation systems in common areas shall be monitored once per month, and any repairs will be made in a timely manner.
3. Watering of common areas and individual landscapes shall be limited to the recommended time of day watering schedule of the water utility unless irrigation of reclaimed water during the day is necessary to meet regulatory requirements.

Soil Specifications:

1. All irrigated and newly planted turf areas will have a minimum settled soil depth of 6 to 8 inches:
 - a. builders and owners will import soil if needed to achieve sufficient soil depth;
 - b. soil in these areas may be either native soil from the site or imported, improved soil;
 - c. improved soil will be a mix of no less than twenty percent compost blended with sand and loam (caliche shall not be considered as soil);
 - d. undisturbed, non-irrigated natural areas are exempt from these requirements.
2. In new development:
 - a. native soil shall be stockpiled and reused on site;

- b. topsoil that is added to the site shall be incorporated in a 2 to 3 inch scarified transition layer to improve drainage.

Planting Specifications:

1. Builders shall offer homeowner a conservation landscape option such as the LCRA Hill Country landscape Option that includes only plants selected from native and adapted plant list approved by the LCRA. Turf that is used as part of this option shall have summer dormancy capabilities.
2. New developments shall have an example of a conservation landscape, including appropriate soil depth, plant choice, plant spacing and efficient irrigation system at a minimum of one model home and/or at a community/amenity center
2. Invasive plants listed in this document shall not be used.
3. No more than fifty percent of the landscape may be planted in turf.

Landscape Chemical Use Specifications:

1. Landscape companies providing maintenance on all common areas and individual landscapes must only use integrated pest management (IPM) to minimize exposure of storm water runoff to chemicals (fertilizers, herbicides and pesticides). IPM techniques shall include the following steps:
 - a. accurately identify pest or disease problem before considering treatment;
 - b. explore cultural or mechanical controls (i.e. modification of irrigation, pruning, etc);
 - c. look for biological control options (i.e. predatory insects for pest control, Bt for caterpillar control, etc);
 - d. consider chemical control only if other options fail;
 - e. utilize least-toxic and targeted chemical controls;
 - f. baits are preferable to broad-spectrum chemical application;
 - g. follow instructions on chemical labels exactly; and
 - h. perform periodic monitoring for early detection of potential problems.
2. Landscape companies providing maintenance on all common areas and individual landscapes shall use the following fertilizer practices:
 - a. fertilization of turf areas shall not be required;
 - b. in turf areas that are to be fertilized, natural or certified organic fertilizers with less than 4% phosphorus shall be used;

- c. fertilizer shall be applied at a rate of $\frac{1}{2}$ pound of nitrogen per 1000 square feet, not to exceed a total of one pound of nitrogen per 1000 square feet per year.
3. Builders or property managers must present guidelines for IPM plans and fertilizer practices meeting the deed restriction requirements to home buyers at the time of closing. These guidelines shall also be included in HOA or POA landscape maintenance contracts.

List of Invasive Plants Not Acceptable for Use

The following list comes from the August 2004 edition of the Grow Green Guide to Native and Adapted Landscape Plants.

Trees to Avoid

Chinaberry	<i>Melia azedarach</i>
Chinese Parasol Tree	<i>Firmiana simplex</i>
Chinese Pistache	<i>Pistacia chinensis</i>
Chinese Tallow	<i>Sapium sebiferum</i>
Mimosa (non-native)	<i>Albizia julibrissin</i>
Paper Mulberry	<i>Broussonetia papyrifera</i>
Salt Cedar	<i>Tamarisk spp.</i>
Tree of Heaven	<i>Ailanthus altissima</i>
Vitex	<i>Vitex agnus-castus</i>
White Mulberry	<i>Morus alba</i>

Shrubs to Avoid

Chinese Photinia	<i>Photinia spp.</i>
Common Privet	<i>Ligustrum sinense, L. vulgare</i>
Japanese Ligustrum	<i>Ligustrum lucidum</i>
Nandina (berrying varieties)	<i>Nandina domestica</i>
Pyracantha	<i>Pyracantha spp.</i>
Russian Olive	<i>Elaeagnus angustifolia</i>
Wax Leaf Ligustrum	<i>Ligustrum japonicum</i>

Vines to Avoid

Cat's Claw Vine	<i>Macfadyena unguis-cati</i>
English Ivy	<i>Hedera helix</i>
Japanese Honeysuckle	<i>Lonicera japonica</i>
Kudzu	<i>Pueraria lobata</i>
Vinca	<i>Vinca major, V. Minor</i>
Wisteria (non-native)	<i>Wisteria sinensis, W. floribunda</i>

Other Plants to Avoid

Elephant Ear	<i>Alocasia spp., Colocasia spp.</i>
Giant Cane	<i>Arundo donax</i>
Holly Fern	<i>Cyrtomium falcatum</i>
Running Bamboo	<i>Phyllostachys aurea</i>